

TNO report

TNO 2022 R10365

**Dutch In-service Emissions Measurement
Programme for Light-Duty Vehicles 2021 and
status of in-vehicle NO_x monitoring**

Traffic & Transport

Anna van Buerenplein 1
2595 DA Den Haag
P.O. Box 96800
2509 JE The Hague
The Netherlands

www.tno.nl

T +31 88 866 00 00

Date 28 February 2022

Author(s)

Copy no	2022-STL-REP-100343802
Number of pages	52 (incl. appendices)
Number of appendices	3
Sponsor	Dutch Ministry of Infrastructure and Water Management PO Box 20901 2500 EX THE HAGUE The Netherlands
Project name	Emissie meet- en monitoringsprogramma voertuigen
Project number	2021 060.45068

All rights reserved.

No part of this publication may be reproduced and/or published by print, photoprint, microfilm or any other means without the previous written consent of TNO.

In case this report was drafted on instructions, the rights and obligations of contracting parties are subject to either the General Terms and Conditions for commissions to TNO, or the relevant agreement concluded between the contracting parties. Submitting the report for inspection to parties who have a direct interest is permitted.

© 2022 TNO

Samenvatting

Euro 6 wetgeving van kracht

Sinds 1992 dragen opeenvolgende Euro standaarden bij aan het terugdringen van voertuigemissies. Op dit moment is in dit kader de zogenaamde 'Euro 6 standaard' van kracht waaraan alle nieuwe wegvoertuigen moeten voldoen. Fabrikanten moeten aantonen dat dit het geval is door hun voertuigen een 'real driving emissions' (RDE) test te laten ondergaan waarbij de emissies van het voertuig op de weg worden bepaald met een 'Portable Emission Measurement System' (PEMS). In deze wetgeving is ook opgenomen dat onafhankelijke partijen zoals typegoedkeuring instanties het emissiegedrag van deze voertuigen in de praktijk, onder normaal gebruik, controleren. Dit valt onder In-Service Conformity (ISC) testen. Door de RDE wetgeving kan veel beter worden getest of voertuigen op de weg aan de gestelde emissie eisen voldoen. Om te kunnen voldoen aan de geldende wetgeving voor de uitstoot van NO_x en fijnstofdeeltjes, voorzien fabrikanten hun voertuigen van complexe uitlaatgasnabehandelingssystemen. Defecten in zulke systemen kunnen leiden tot sterke verhoging van de uitstoot. Om een katalysator voor de reductie van NO_x goed te laten werken is een regelsysteem nodig waarbij sensoren de actuele NO_x concentraties in de uitlaat meten, voor, en na de katalysator. De data die van deze sensoren afkomstig zijn, kunnen interessant zijn om te controleren of een katalysator goed werkt.

Doel van het project

In opdracht van het Ministerie van Infrastructuur en Waterstaat voert TNO jaarlijks voertuigemissiemetingen op de weg uit. Dit rapport presenteert de resultaten van in 2021 uitgevoerde emissiemetingen aan drie Euro 6 dieselveertuigen en aan één Euro 6 benzineauto. Daarbij is niet alleen onderzocht hoe deze voertuigen op de weg qua emissies presenteren maar ook of data van de NO_x-sensoren van een testvoertuig konden worden uitgelezen via de On-Board Diagnostics (OBD) van het voertuig. Onderzocht is of deze data een goed beeld gaven van de voertuigemissies in vergelijking met de data verkregen met het voor de metingen door TNO toegepaste emissiemeetsysteem. Tijdens het onderzoek hebben de voertuigen ieder gedurende vier weken verschillende gedefinieerde ritten gereden waaronder een rit die overeenkomt met de RDE condities. Emissies van de dieselveertuigen zijn daarnaast ook gemonitord tijdens willekeurig gereden ritten.

Emissieniveaus bij normaal gebruik onder gestelde Euro 6 grenswaarden

Voor elk getest voertuig lagen tijdens de metingen de gemiddelde NO_x-emissieniveaus per rit ruim onder de RDE NO_x-grenswaarde, dit was vooral het geval bij de gereden RDE ritten. De hoogste gemiddelde waarden voor de NO_x-emissies traden, voor alle geteste dieselveertuigen, op bij binnen stedelijke ritten en dan vooral in gebieden waar een snelheidsbeperkingen van 30 km/uur gold.

Koude starts vormen de belangrijkste bron van emissies

De NO_x-emissieniveaus die optraden bij een koude start van de motor bleken dominant te zijn voor de emissieprestatie van de geteste voertuigen. Voor nieuwe Euro-7 wetgeving zijn deze koude start emissies bepalend voor de emissielimieten, en hangen daarmee direct samen met de specifieke wettelijke testprocedure. In de praktijk kunnen emissies hoger zijn.

Er is onderzocht wat de meest extreme omstandigheden zijn, met de hoogste koude start emissies. Voor de meeste ritten bedroeg de bijdrage van de koude start NO_x-emissie aan de emissie van een totale rit meer dan 50%. Dit gold zowel bij korte ritten (korter dan 10 km) als bij het grootste deel van de langere ritten. Gemiddeld werd 70% van de totale NO_x-emissie van een rit uitgestoten tijdens de eerste 1400 meter. Conclusie is dat NO_x-emissies in verband met een koude start voor alle geteste voertuigen de belangrijkste emissiebron vormen. Bovendien bleken omstandigheden voorafgaand aan een koude start van invloed te zijn op de waarde van de emissieniveaus. Onder een testconditie waarbij direct na een koude start het gaspedaal diep werd ingedrukt voor een snelle voertuig acceleratie tot een snelheid van 100 km/uur en er vervolgens ongeveer 56 km met het voertuig werd doorgereden, stootten de dieselveertuigen tijdens de koude start periode (tussen 0,8 en 1,5 van de in totaal 56 afgelegde kilometers) tot aan 93% van de totale NO_x emissie van die trip uit. Onder deze startconditie had het voertuig met de hoogste NO_x-emissie, 13 kilometer nodig om het NO_x-emissieniveau binnen de gestelde emissielimiet, voor dit voertuig, van 179 mg/km te laten vallen. Dit toont aan dat sommige moderne voertuigen al voldoen aan strengere eisen dan nu gesteld worden, waarbij tijdens de wettelijke RDE koude start het rijgedrag aan veel voorwaarden moet voldoen.

Het benzinevoertuig liet een korte periode zien waarin, bij een koude start, sprake was van een verhoogde NO_x-emissie. Ongeveer 37% van de totale rit-emissie trad op binnen de eerste 160 meter na start. Voor onverbrande koolwaterstoffen (HC) gold voor dit voertuig dat 76% van de totale uitstoot plaatsvond binnen de eerste 400 meter van de rit.

Langdurig stationair draaien bij normaal gebruik kan leiden tot verhoogde emissies

Bij normaal voertuiggebruik kunnen langere perioden van stationair draaien voorkomen. Bijvoorbeeld tijdens files of bij gebruik als taxivoertuig. Bij herhalend stationair draaien langer dan 300 seconden (300 seconden is een limietwaarde binnen wettelijke RDE test) vertoonden de geteste dieselveertuigen verhoogde NO_x-emissies. De geteste benzineauto vertoonde onder deze conditie geen verhoogde NO_x-emissieniveaus.

Hogere motorbelastingen niet het belangrijkste NO_x-emissieprobleem

Wanneer de motorbelastingen tijdens de willekeurig gereden ritten worden vergeleken met die van de gereden RDE-ritten, blijkt dat tijdens de willekeurige gereden ritten een veel breder bereik van motorbelastingen te zien is, met ook hogere emissies tot gevolg. Een hoge belasting van de motor levert bij de geteste dieselveertuigen echter niet het belangrijkste NO_x-emissieprobleem voor deze bestelauto's. Voorwaarde is wel dat het uitlaatgasnabehandelingssysteem op temperatuur is. Voor dieselveertuigen met hoge motorvermogens is het wel mogelijk dat de nabehandelingstechnologie te klein is. Dit gaat dan met name om rijgedrag bij hoge motorbelasting, die bij de dergelijke voertuigen ver buiten de condities van de wettelijke test ligt. In de onderzoeken voor Euro-7 zijn daar aanwijzingen voor.

Toekomstige emissiewetgeving, Euro -7

Het emissiegedrag van de geteste voertuigen is zeer goed, de resultaten bevestigen resultaten uit eerdere meetprogramma's met Euro 6d en Euro 6d TEMP voertuigen.

Een belangrijke verbetering ten opzichte van de vorige generaties Euro-6 dieselveertuigen, die aan dezelfde emissiegrenswaarden moesten voldoen, maar daarbij niet in emissietests op de weg werden beproefd (alleen in het laboratorium). Het is duidelijk dat de feitelijke details van het testen een groot verschil maken in de emissieprestaties. Bovendien betekent de stap van Euro-6d-Temp naar Euro-6d een verdere aanzienlijke verbetering van de emissies. Als deze niveaus in de nieuwere generaties dieselveertuigen, en gedurende hun hele levensduur, worden gehandhaafd, is hun relevantie voor luchtkwaliteitsproblemen gedecimeerd. Met name ten opzichte van de Euro-5-niveaus, oftewel de niveaus van het dieselschandaal.

Een paar van de nog onopgeloste problemen met Euro-6d diesel NO_x-emissies zijn de dekking van de RDE-tests op de weg, de levensduuremissie met onderhouds- en manipulatieproblemen en het voldoende meenemen van emissies tijdens de koude start. Daarnaast zijn zowel langdurig stationair draaien als hard accelereren uitgesloten van de RDE-test. Geconstateerd wordt dat een aantal voertuigen in deze situaties veel hogere emissies hebben dan anders bij normaal gebruik. Voertuigen lijken te zijn geoptimaliseerd voor goede RDE-prestaties, met een beperkte robuustheid voor andere rij situaties.

In de Adviesgroep voertuigemissienormen zijn deze kwesties aan de orde gesteld. Het huidige voorstel is om de testgrens te verlagen en toe te staan dat elke rit een geldige test is voor toetsing aan de emissiewetgeving. Het voorstel van de Commissie voor Euro 7-wetgeving wordt medio 2022 verwacht en waarschijnlijk wordt deze aanbeveling daarin opgenomen. Hierdoor worden de emissietests uitgebreid en de weinige gevallen waarin een hoge emissie wordt geaccepteerd, verder beperkt.

Beschikbaarheid van NO_x-emissiedata op de OBD van de geteste voertuigen

Alle geteste dieselveertuigen beschikken over een NO_x-signaal op hun OBD connector. Echter, alleen een sensor die is geplaatst achter het uitlaatgasnabehandelingssysteem geeft informatie over de NO_x-emissie uit de uitlaat en dit is bij slechts bij één van de drie nu geteste voertuigen het geval. Signalen van NO_x-sensoren die op andere plaatsen zijn gemonteerd zijn ongeschikt voor monitoring van uitgaande NO_x-emissies. Op basis van de naamgeving van de signalen kon niet eenduidig worden vastgesteld van welke sensor data beschikbaar was. Verder is gebleken dat deze sensorsignalen pas beschikbaar komen na een opstarttijd van 60 tot 1500 seconden. Dat betekent dat koude start emissies niet op deze wijze gemonitord kunnen worden. Uit een vergelijking van de data afkomstig van deze sensoren met die van het gebruikte emissiemeetsysteem bleek dat deze onderling vaak sterk kunnen afwijken. Meer onderzoek is nodig om beter inzicht in te krijgen in de oorzaak van deze verschillen. Desondanks wordt verwacht dat voertuig-eigen NO_x-sensorsignalen, onder voorwaarden, potentie hebben voor inzet ten behoeve van NO_x-monitoring.

Een aantal fabrikanten van personenauto's en lichte bestelbussen gaf, desgevraagd, aan dat zij geen online NO_x-monitoring (waarmee automatisch NO_x-emissie data verzameld kan worden) hebben geïmplementeerd in hun Euro 6 NH voertuigen. Zij gaven aan dat de discussie over de eigendom van de gegevens een probleem kan vormen wanneer online NO_x-bewaking door de fabrikanten zelf wordt toegepast. Daarvoor is eerst toestemming van de voertuigeigenaar nodig.

Summary

Background

In order to reduce pollutant exhaust emissions from road vehicles, the European Commission introduced the first emission Euro standards in 1992. In 2017 new emission legislation was finalized and introduced. The major difference with the previous emission legislation is the introduction of on-road emissions testing with 'Portable Emission Measurement System' (PEMS). This is also referred to as 'Real Driving Emissions (RDE). Initially, the first vehicles had to comply with a less stringent limit in on-road testing. These vehicles had a temporary conformity factor of 2.1 for NO_x emissions (the NO_x emission limit during on road testing was 2.1 times higher than during laboratory testing), these vehicles are referred to as Euro-6d-Temp vehicles. From 2019 to 2021 all light duty vehicles, passenger cars and vans have to satisfy a more stringent conformity factor of 1.43. These vehicles are referred to as Euro-6d (final) vehicles. Moreover, another part of the RDE legislation is that independent parties, such as type-approval authorities should check the emission performance in normal use in In-Service Conformity (ISC) testing. From 2021 Type Approval Authorities must publish their results on-line, but only a few reports could be found so far.

The introduction of RDE legislation successfully reduced a large part of the gap between type approval emissions and emissions during real-world driving. I.e., the emission performance of these vehicles is very good, a major improvement over the previous generations Euro-6 vehicles. Nevertheless, there are still circumstances where elevated pollutant emissions may occur.

To comply with emission limits of Euro 6d (Temp and higher), corresponding vehicles are equipped with complex exhaust gas aftertreatment systems, like SCR catalysts (Selective Catalytic Reduction) to reduce NO_x emissions and diesel particulate filters (DPF). Malfunctions with such systems cause a substantial increase in emissions. An SCR system has one- or more NO_x sensor(s) in the exhaust pipe, which is needed for a proper working of the system. While their primary purpose is to deliver input for the SCR system, these in-vehicle NO_x sensors can measure the NO_x emissions in real-world conditions and therefore they could potentially be an interesting source of on-road NO_x emission data.

On behalf of the Dutch Ministry of Infrastructure and Water Management, TNO yearly performs on-road emission measurements in order to determine real-world emissions performance of vehicles. In 2021, the project also investigated the availability and possibilities of in-vehicle NO_x data. Moreover, it was investigated whether vehicle manufacturers already monitor this data online.

Measurement programme

This research started with a desk study on the Dutch Euro 6d final (from here on indicated as Euro 6d) vehicle fleet composition to determine which makes and/or models are representative. After vehicle selection, three diesel vehicles and one petrol vehicle were rented. TNO's Smart Emission Measurement System (SEMS) was installed in the selected diesel vehicles. With the sensors that come with SEMS the NO_x and NH₃ emissions in the exhaust pipe were measured.

For emission measurements on the petrol vehicle a Portable Emission Measurement System (PEMS) was installed. During all measurements, the data available at the OBD ports of the vehicles were logged, with special attention for the OBD NO_x signals. During the test period of sixteen weeks (four weeks per vehicle) the vehicles have been driven different prescribed trips. In addition, the diesel vehicles were monitored during random real-world trips as well. Moreover, an RDE route (in accordance with RDE trip requirements) was driven with all test vehicles.

Measurement results with regard to real-world emission performance

Emission levels within RDE boundaries in daily use

For every tested vehicle, the average NO_x emission levels per trip during the measurement campaign are well below the RDE NO_x limit. Especially during the driven RDE trips, the average NO_x emissions were very low (< 10 mg/km). Also, during the monitoring phase (trips without specific instructions), the average NO_x emissions over all trips combined are low (<50 mg/km). The highest average NO_x emissions occurred for all diesel vehicles while driving in urban areas. Especially areas with a speed limit of 30 km/h showed higher NO_x emissions. For the Citroën Berlingo the average emissions in these areas were approximately 220 mg/km. The VW Caddy ad Peugeot Expert showed substantially lower emission with respectively 120 and 100 mg/km. During the RDE trips, NO_x emissions in urban areas were substantially lower, for all vehicle below 10 mg/km. The NO_x emissions during rural and motorway driving are consistently low for all three diesel vehicles.

Cold engine start emissions; the remaining emission source, beyond 2030

The NO_x emissions associated with a cold engine start are dominant in the NO_x emission performance for the tested Euro 6d diesel vehicles. The contribution of the cold start NO_x emissions to the total trip emissions is considerably more than 50% for the majority of the trips. This holds true for short trips of 10 kilometers or less, but also for a large part of the longer trips. On average 70% of the total trip NO_x emissions is emitted during the first 1.4 kilometers of the cold start trip. On average 70% of the total trip emissions is emitted during the first 1.4 kilometres. The emissions associated with the cold engine start vary per vehicle, but it is for all vehicle the dominant emissions source. Moreover, the conditions prior to a cold engine start trip have an influence on the magnitude of the cold start emissions.

In addition, a worst-case test was performed, i.e. a wide-open throttle acceleration (0 to 100 km/h) directly after a cold engine start, after this wide-open throttle acceleration the vehicle kept driving on the motorway for approximately 56 kilometers. During the cold start period (between 0.8 and 1.5 km), the vehicles emit up to 93% of the total trip (56 km) NO_x emissions, despite multiple wide-open throttle accelerations on the motorway after the cold start period. Under these starting conditions, the vehicle with the highest emissions needs a trip of approximately 13 kilometers to comply with the emission limit of 179 mg/km. This shows that some modern vehicles already comply with stricter requirements than those currently in force, whereby during the legal RDE cold start, the driving behaviour has to meet many conditions.

The tested petrol vehicle, which was less extensively tested than the diesel vehicles, showed a shorter cold start period with a lower impact on NO_x emissions.

On average 37% of the total trip NO_x emissions were emitted during the first 160 meters. Moreover, 76% of the total trip THC emissions were emitted during the first 400 meters.

Since the lifespan of these vehicle is more than 10 years, the cold engine start effect is expected to have a significant contribution to local air pollution beyond 2030.

Prolonged idling in normal use can lead to elevated emissions

Elevated emissions can occur during prolonged idling events with the tested diesel vehicles. NO_x emissions during these events can be up 1.0 mg/s, depending on the vehicle and/or engine strategy. To put the 1.0 mg/s NO_x emission in broader perspective: if a vehicle would drive 25 km/h while it emits NO_x at a rate of 1.0 mg/s, the NO_x emission is 144 mg/km. The RDE trip requirements describe an idling time limit of 300 seconds. For multiple idling events the elevation of NO_x emissions starts after 300 seconds. The tested petrol vehicle did not show high emissions during idling. In normal use of vehicles, long idling events are not uncommon. Taxi's idle while waiting for passengers, vehicles queuing in traffic accidents, and vehicles waiting for open bridges are examples of prolonged idling events that result in additional NO_x emission.

High engine load; not the main issue for NO_x emissions

The diesel vehicles show in general an increase in NO_x emissions at higher levels of dynamic driving, which also includes higher engine loads. When the engine loads during on-road monitoring are compared to the driven RDE trips, the on-road monitoring data show a much wider coverage of engine loads, with higher emissions as well. However, high engine loads are not the main source of elevated NO_x emissions for the diesel vehicles, as long as the after-treatment system has reached operating temperature. The NO_x emissions are in general not disproportionately increasing at higher engine loads. However, for diesel vehicles with a high engine power, the aftertreatment technology may not have sufficient capacity. This mainly concerns driving behaviour with high engine loads, which is for such vehicles far outside the conditions of the RDE test. There are indications for such effects in the Euro-7 studies.

Future legislation, Euro-7

The emission performance of the tested vehicles is very good. This confirms the results which were shown in earlier test programmes with Euro-6d and Euro 6-TEMP diesel vehicles. A major improvement over the previous generations Euro-6 diesel vehicles, which had to satisfy the same emission limits, but not in on-road emission tests. Clearly, the actual details of testing make a large difference in the emission performance. Moreover, the step from Euro-6d-Temp to Euro-6d is a further significant improvement in emissions. If these levels are maintained in the newer generations of diesel vehicles, and over their lifetime, their relevance for air-quality problems is decimated, from the Euro-5, or diesel scandal, levels.

A few of the outstanding issues with Euro-6d diesel NO_x emissions are the coverage of the on-road RDE tests and the lifetime emission with maintenance and tampering issues. Both prolonged idling and hard accelerations are excluded from the RDE test. It is observed that a number of vehicles have much higher emissions in these situations than otherwise in normal use. Vehicles seem optimized for good RDE performance, with limited robustness for other driving situations.

Moreover, cold start emissions have a limited contribution in the overall RDE test result that is compared with the limit. In the Advisory Group on Vehicle Emissions Standards these issues were raised, and the current proposal is to reduce the test boundary, and allow any trip to be a valid test for evaluation against the emission legislation. The Commission proposal for Euro-7 legislation is expected mid 2022, and likely this recommendation is included, extending the emission testing, and limited further the few cases in which high emissions are accepted.

Results with regard to in-vehicle NO_x data

Online OBD NO_x monitoring

Multiple Light-duty vehicle manufacturers indicate that no online NO_x monitoring is applied on their Euro 6d vehicles. Respondents added that the discussion of data ownership could be an issue when online NO_x monitoring is applied by the manufacturers themselves. Each vehicle owner must agree on sharing its data with the manufacturer in a scenario where online OBD NO_x monitoring is applied.

In-vehicle NO_x sensor emission monitoring

The Euro 6d diesel vehicles measured in this project all have a NO_x signal available on the on-board diagnostics (OBD) port of the vehicle. However, the suitability of an in-vehicle NO_x sensor signal for emission monitoring purposes strongly depends on its position in the exhaust pipe. It's important to know if the signal is pre-SCR catalyst or post- SCR catalyst and if the sensor represents tailpipe out emissions or if there is another catalyst like the ASC (Ammonia Slip Catalyst) after the NO_x sensor. Pre-catalyst in-vehicle NO_x sensors are not suitable for determining tailpipe-out NO_x emissions. The position of an in-vehicle NO_x sensor in the exhaust pipe can't be determined by its naming when reading it from the OBD port. It is therefore not always clear which OBD NO_x signal corresponds to which NO_x sensor in the exhaust pipe. This study showed that the in-vehicle NO_x sensor signal is different for each test vehicle regarding its naming, position and availability. In this project only one of the three tested diesel vehicles have a tailpipe-out in-vehicle NO_x sensor. The other two vehicles only have pre-SCR and pre-ASC NO_x sensors available on the OBD port.

For all three vehicles, the NO_x signal on the OBD port needs significant start-up times (ranging from 60 to 1500 seconds). The data shows that the start-up duration is not a fixed amount of time. More detailed research is needed for a better understanding if these start-up times are related to specific conditions. This will make it currently impossible to measure NO_x emission during the cold engine start period. The emissions related to the cold engine start period are dominant compared to other circumstances, like high engine loads. Moreover, the in-vehicle NO_x signal often correlates not very well with measurements from independent measurements (with SEMS). There were, however, some trips with only small deviations between the results from the in-vehicle signals and SEMS. A more detailed analysis is needed for a better understanding between these observed differences. More understanding is needed if the differences are related to specific conditions, like exhaust temperature, engine load and driving dynamics.

NO_x monitoring via in-vehicle signals is currently not an accurate method to assess the NO_x emission performance. Nevertheless, under certain conditions it can be an interesting method to gather data on NO_x-performance.

The in-vehicle NO_x sensors have potential for accurate NO_x monitoring purposes when:

- it is clear which OBD NO_x signal corresponds to which NO_x sensor;
- there is a NO_x sensor located post-catalysts / tailpipe-out;
- the NO_x sensor is active at the start of the trip in order to include cold start emissions;
- the OBD NO_x signal can be combined with other parameters to determine the exhaust mass flow, like the Mass Air Flow- and O₂ signals (for emission mass-flow calculations),

If a vehicle does not comply with these points, it's not suitable for an accurate NO_x emission monitoring fully based on the in-vehicle signals. However, if the signal and the quality of the in-vehicle NO_x sensor is better understood, the availability of the OBD NO_x signal and location of the sensor only can potentially be useful for other purposes than accurate emission monitoring.

It may be possible to determine elevated emissions in case of:

- Malfunction of the aftertreatment system, due to a defect or manipulation;
- Detection of elevated emissions in specific conditions (e.g. for conditions which are not covered in the emissions legislation);
- Monitoring of possible deterioration of the after-treatment system (the deterioration or malfunctions of the NO_x sensor itself should be considered as well).

Contents

Samenvatting	2
Summary	5
1. Introduction	11
1.1 Background	11
1.2 Project goals	13
1.3 Structure of this report	13
2. Research questions, methodology and test program	14
2.1 Research questions	14
2.2 Methodology	14
2.3 Test program	14
2.4 Vehicle availability and selection	15
2.5 SEMS installation	16
3. Observations: Real-world emission can vary greatly dependent on driving situations	17
3.1 Emission levels within RDE boundaries in daily use	17
3.2 Cold engine start emissions; the remaining emission source, beyond 2030	19
3.3 Keeping the catalyst warm and buffering during idling	24
3.4 High engine load; not the main issue for NO _x emissions	27
4. NO_x monitoring, based on in-vehicle signals	32
4.1 Online NO _x monitoring	32
4.2 Availability and reliability	32
4.3 Comparison with SEMS measurement results	35
4.4 Discussion: Emission level determination through in-vehicle signals	39
5. Emission factors; a new category	41
6. Conclusions	42
7. Abbreviations	46
8. References	47
9. Signature	48
Appendices	
A SEMS Euro 6d installation schematic	
B Test program & driving styles	
C Engine power: RDE versus on-road monitoring	

1. Introduction

1.1 Background

In order to reduce pollutant exhaust emissions from road vehicles, the European Commission introduced the first emission Euro standards in 1992. As shown in Figure 1.1, these emission standards have become more stringent over the years. From September 2017 the Euro 6d-Temp emission standard was introduced for new light-duty passenger vehicles (M1) and light commercial vehicles (N1 class 1, ≤ 1305 kg). The major difference between Euro 6d-TEMP and the first generation Euro 6, is the introduction of on-road emissions testing with 'Portable Emission Measurement System' (PEMS). This is also referred to as 'Real Driving Emissions (RDE)'. It should be noted that, although the legislation is called Real Driving Emissions, there are still many restriction on the driving behaviour and the test, which limits the coverage of all normal use.¹ From 2020 onwards Euro 6d-(final) is in force for these vehicle types. With Euro '6d final' additional requirements are implemented, like a lower conformity factor and In-Service-Conformity Real-Driving Emissions (ISC-RDE). The ISC-RDE is a monitoring program with yearly emission tests in order to verify that in-use vehicles still comply with the emission type approvals. The introduction of RDE in the Euro 6d-TEMP legislation successfully reduced a large part of the gap between type approval emissions and emissions during real-world driving. Nevertheless, there are still circumstances where elevated pollutant emissions may occur, these are elaborated in more detail in this report.

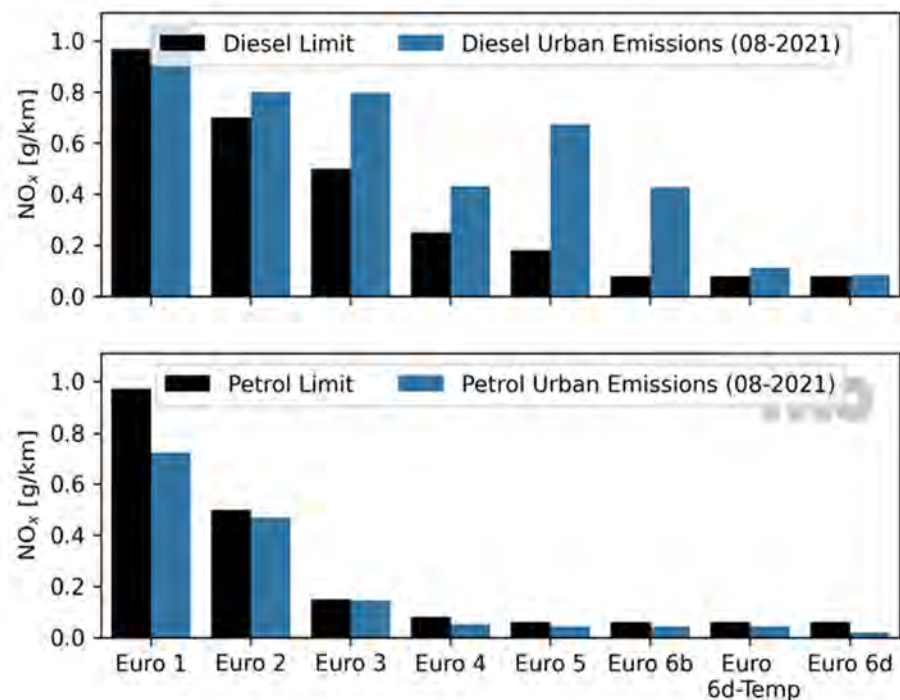

Figure 1.1: NO_x Emission factors for urban traffic and type approval limit values of Euro 1-6 diesel (top) and petrol (bottom) M1 & N1 Class 1 vehicles.

¹ TNO 2019 R10534, Update: Assessment of risks for elevated emissions of vehicles outside the boundaries of RDE, TNO 2017 R11015, Review of RDE legislation.

On behalf of the Dutch Ministry of Infrastructure and Water Management TNO yearly performs on-road emission measurements in order to determine real-world emissions performance. These measurement results provide insights in the strengths and weaknesses of the emission legislation. For example, by showing the circumstances where elevated emissions occur. Figure 1.2 shows the coverage of operations conditions of the WLTP test and the Euro 6 RDE in comparison to the vehicle performance. It shows that type approval emission testing only covers vehicle operation in moderate conditions, while high emissions may still occur during low load- and high load operations. These insights are being used to substantiate input for creating robust future emission legislation. Furthermore, the emission measurement results serve as input for calculating emission factors for air quality models.

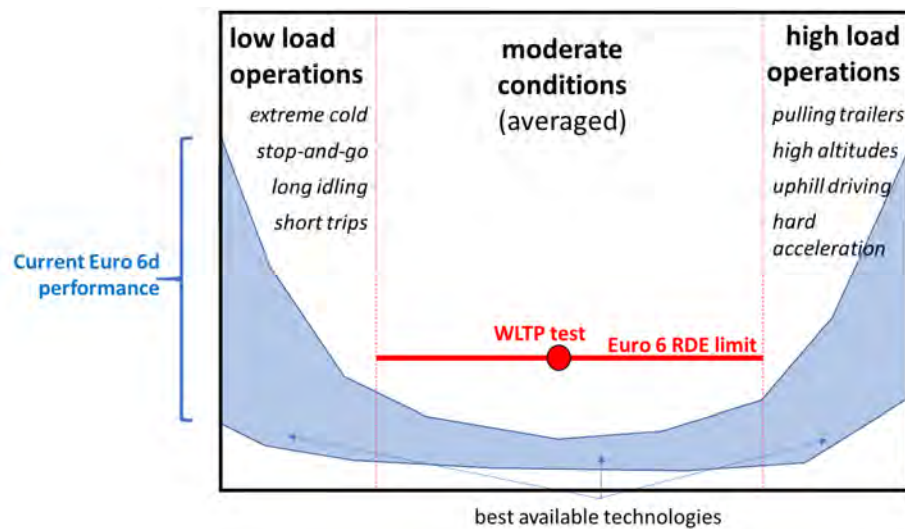

Figure 1.2: Graphic representation of current Euro 6d vehicle performance (blue band) in the context of RDE testing. The WLTP laboratory test is a very specific subset of moderate driving conditions (as indicated by the red dot). Comparatively, the RDE test addresses a much wider range of driving conditions (as shown by the red line), though these conditions could still, on average, be described as moderate. The current RDE testing procedure does not test for low load (such as extreme cold, stop-and-go traffic, long periods of idling, or short trips) or high load (e.g. pulling trailers, driving at high altitude, driving uphill, or hard acceleration) operations. Source: TNO 2020 R12024.

To comply with emission limits of Euro 6d-Temp and higher, diesel vehicles are equipped with complex exhaust gas aftertreatment systems, like SCR catalysts and diesel particulate filters (DPF). Malfunctions with such systems cause a substantial increase in emissions.

An SCR system has one- or more NO_x sensor(s) in the exhaust pipe, which is needed for a closed loop SCR control system. While their primary purpose is to deliver input for the SCR system, these in-vehicle NO_x sensors can measure the NO_x emissions over a wide range of vehicle operation and therefore they could potentially be an interesting source of on-road NO_x emission data.

Therefore, the project also investigated the availability and usability of this NO_x data on the OBD of the tested vehicles and whether vehicle manufacturers already monitor this data online.

1.2 Project goals

The main goals of this project are:

- To pinpoint situations with elevated emissions which are not covered in the current emission legislation. This knowledge serves as input for the discussion in the development of Euro 7.
- To investigate if manufacturers already implement online NO_x monitoring by automatically collecting the vehicle NO_x-sensor data for further analysis and development purposes, services to vehicle owners or other applications.
- To investigate if (and how) the in-vehicle NO_x sensors can be used for NO_x emission monitoring through the vehicle's OBD port.

1.3 Structure of this report

In chapter 2 the research questions, methodology, test program, vehicle selection and the installation of emission measurement equipment is described. In chapter 3 the observations regarding circumstances with elevated emissions, like cold start emissions, catalyst buffering, and high engine load are shown. Chapter 4 describe the possibilities of NO_x monitoring using in-vehicle NO_x sensors. The effect of the emission test program results and emission monitoring results on the current emission factors is explained in chapter 5, followed by the conclusions of the project results in chapter 6.

2. Research questions, methodology and test program

2.1 Research questions

In this project desk study and experiments are conducted in order to find answers to the following research questions:

- What are the remaining emission issues during real-world driving?
- What is the availability and quality of in-vehicle NO_x signals on the OBD?
- Are in-vehicle NO_x signals applicable for NO_x monitoring purposes?
- Is online NO_x monitoring already applied by vehicle manufactures?
- Can a vehicle do a self-check on NO_x emission levels?

2.2 Methodology

This research started with a desk study on the Dutch Euro 6d vehicle fleet composition to determine which makes and/or models are representative. The fleet data used for this analysis is a RDW OpenData set, obtained on the 12th of March 2021. The RDW OpenData set contains every registered vehicle in the Netherlands, including their characteristics, like emission class and fuel type. After vehicle selection, three diesel vehicles and one petrol vehicle were rented. TNO's Smart Emission Measurement System (SEMS) was installed in the selected diesel vehicles. With the sensors that come with SEMS the NO_x and NH₃ emissions in the exhaust pipe are logged at 1Hz for on-road NO_x- and NH₃ emission monitoring. For emission measurements on the petrol vehicle a Portable Emission Measurement System (PEMS) was applied. During all measurements, also data available at the OBD ports of the vehicles were logged. A more detailed description of the methodology of on-road emission testing can be found in the TNO methodology report [TNO 2016a].

For each vehicle the gathered emission data is post-processed to calculate mass-based emission values in milligram per kilometre and per second. The emission values under different trip conditions are compared with each other and with the type approval limit.

2.3 Test program

During the test period of sixteen weeks (four weeks per vehicle) the vehicles have been driven different prescribed trips, in addition the diesel vehicles were monitored during random real-world trips as well. To cover a wide range of engine operation the vehicles have been driven eco-style without extra payload as well as sportive driving with maximum payload. Also, an RDE route (in accordance with RDE trip requirements) was driven with all test vehicles. Moreover, tests with prolonged idling were performed as well as trips with a cold engine start. The emission test program consisted of five defined trips and an emission monitoring phase in which the vehicle was driving random in real-world traffic. Table 2-2 shows how many hours of emissions data is gathered. Note there is one petrol vehicle that has undergone a different measurement program. More details on the five predefined emission tests and driving styles are shown in the Table 2-1 below.

Table 2-1: Predefined emission test program trips

No.	Trip Name	Road Type(s)	Start condition	Payload [%]	Driving style	Distance [km]
1	RDE_H	Urban / rural / motorway	Warm start	55	Regular	74.7
2	Congestion*	Motorway, morning traffic	Cold start	55	Regular	85.3
3	City	Urban	Warm start	55	Regular	27.8
4	Rural	Rural	Warm start	55	Regular	64.5
5	Full load	Motorway	Cold start	95	Sportive	74.7**

* Limited congestion due to Covid-19 measures.

** Only full load cold start during 0-100 km/h acceleration at the start of the 74.7 km trip.

2.4 Vehicle availability and selection

The vehicles selected for this project are all Euro 6d vehicles, chosen since the Euro 6d legislation is the successor of Euro 6d-TEMP vehicles. In a desk study the Dutch M1- and N1 vehicle fleet was analysed for best sold Euro 6d brands and models. It appeared that M1 diesel Euro 6d vehicles, i.e., passenger cars, were barely registered in the Dutch fleet, thus making it almost impossible to get hands on such a vehicle for emission testing. Dealers pointed out that their stock of new Euro 6d passenger vehicles (M1) only consist of petrol vehicles. There were plenty of Euro 6d light commercial (N1) diesel vehicles and therefore a selection was made from the top ten best sold N1 models/types. Three light commercial vehicles (N1) and one small petrol passenger car were selected. All four vehicle have a mileage below 4.500 km. The small petrol vehicle was selected to examine the effect on emissions of a configuration with a small engine with an aftertreatment system. The makes, models and specifications of the four selected vehicles are shown in Table 2-2. The light commercial vehicles have a classification suffix which is determined by their weight classes. N1-II vehicles have a reference mass between 1305 kg and 1761 kg. N1-III vehicles have a reference mass more than 1760 kg.

The Euro 6d vehicles selected during the desk study are identified by the EC type-approval number. This number refers to the applicable legislation for that specific vehicle. This number is followed by one or two alphabetical character(s) which refers to the applicable emission standard as described in Appendix 6 of Commission Regulation 2018/1832. For this project only vehicle categories M1 and N1 apply.

Table 2-2: Specifications of the tested Euro 6d vehicles.

	Volkswagen Caddy	Peugeot Expert	Citroën Berlingo	Peugeot 108 (petrol)
Power [kW]	55	90	56	53
Engine volume [cm ³]	1.968	1.997	1.499	998
EU Vehicle category	N1-II	N1-III	N1-II	M1
Actual weight [kg]	1.571	1.810	1.419	897
Exhaust gas aftertreatment system	DOC SCR-on-DPF, SCR, ASC	DOC, SCR, DPF, ASC	DOC, SCR, DPF, ASC	TWC
Euro class	6d 'AQ' (ISC, OBFCM)	6d 'AO' (ISC)	6d 'AN' (ISC)	6d 'AP' (ISC, OBFCM)

<i>Odometer at start [km]</i>	1.560	2.111	3.074	4.330
<i>Date of first registration [dd-mm-yyyy]</i>	15-02-2021	11-03-2021	26-02-2021	25-02-2021
<i>Hours of data [h] (SEMS)</i>	34	50	46	6 (PEMS)
<i>Total distance [km] (SEMS)</i>	1.293	2.045	1.896	225 (PEMS)
<i>NO_x limit [mg/km]</i>	105	125	105	60
<i>NO_x limit with CF [mg/km] *</i>	150	179	150	86

*Conformity factor of 1.43

2.5 SEMS installation

The SEMS has been installed on all three diesel vehicles in this project.

As also shown in Figure 2.1 after the last catalyst the following sensors were installed:

- NO_x/O₂ sensor
- NH₃ sensor
- Thermocouple

In addition, the SEMS logs data from the vehicle's OBD port via an interconnecting cable. On the vehicle's CAN-bus an inductive sensor was installed in order to 'listen' to the raw communication between the vehicle and its NO_x sensor. Also, a GPS and GPRS antenna were installed inside the vehicle. The sensors, OBD port, GPS antenna and GPRS antenna were all connected to the SEMS which draws its power from the vehicle's fuse box. A schematic overview of the setup can be found in Appendix A.



Figure 2.1: A NH₃, a thermocouple and a NO_x sensor installed at the end of an exhaust pipe.

3. Observations: Real-world emission can vary greatly dependent on driving situations

In this chapter, results of the measurements are presented and discussed. Each paragraph focusses on a specific topic.

3.1 Emission levels within RDE boundaries in daily use.

For each vehicle, the average NO_x emission levels per trip of the test program (Table B-1 in Appendix B) is well below the RDE NO_x limit, see Figure 3.1. The Peugeot 108 petrol vehicle is the only one which is measured with PEMS and did not participate in the other trips of the test program. Moreover, this vehicle is the only vehicle that performed the RDE trip with a cold start. Nevertheless, the NO_x emission result of this vehicle is well below the NO_x RDE limit for M1 category vehicles. Also, for the other regulated pollutants the emission results are within the limits. Figure 3.1 demonstrates that the diesel vehicles have very low NO_x emission results during the performed RDE trips, especially in comparison to the RDE limits and the average monitoring emissions. During the RDE trips, the diesel vehicles have comparable NO_x emissions as the petrol vehicle.

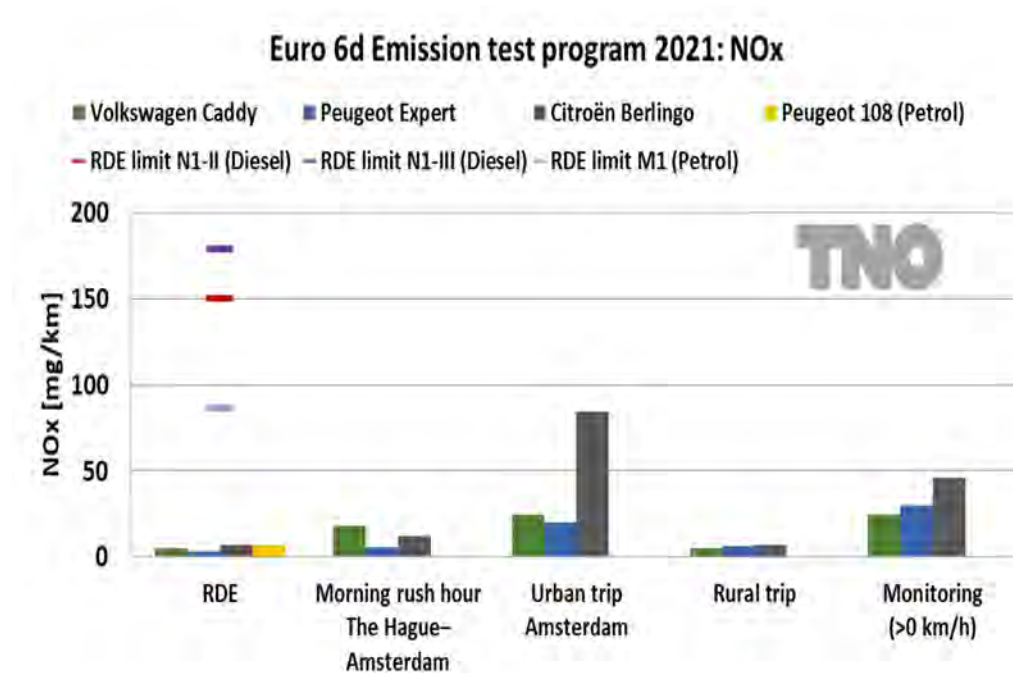

Figure 3.1: NO_x emission results per test trip of the emission test program for three Euro 6d diesel vehicles and one Euro 6d petrol vehicle. The Peugeot 108 petrol was measured with PEMS and did not participate in the emission test program besides the RDE trip. The RDE trips for the diesel vehicles include a hot start and the RDE trip for the Peugeot 108 include a cold start.

In the urban trip through the city of Amsterdam two vehicles perform comparable to the average NO_x emission during monitoring. The elevated NO_x emission of the Citroen Berlingo in the urban trip is remarkable. Figure 3.2 illustrates that during monitoring the average NO_x emission in urban areas with a speed limit of 30 km/h is over 200 mg/km for the Citroën Berlingo. The Peugeot Expert and the Volkswagen Caddy have a significantly lower NO_x emission in this area. However, the emissions at 30 km/h show for all vehicles the highest or nearly the highest emissions compared to the other speed bins. Figure 3.2 also clearly show that the highest emissions occur in urban areas. The NO_x emissions during rural and motorway driving are consistently low for all three diesel vehicles.

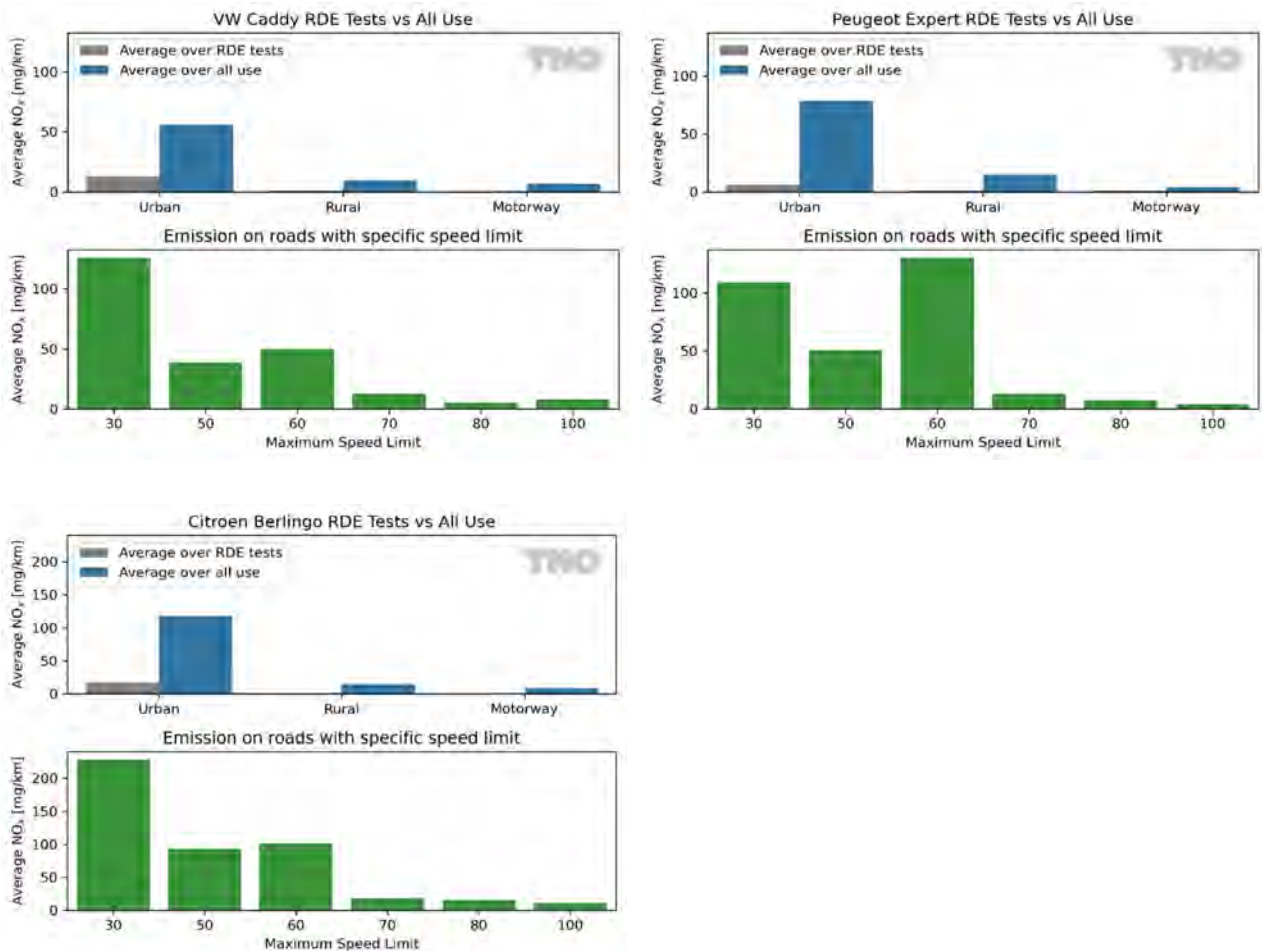

Figure 3.2: A comparison of RDE NO_x emission results versus all-use (monitoring) emission results, subdivided per road type. There is a significant difference in the RDE results and all-use results. Also the all-use average NO_x emission results per speed limit is shown. All three vehicles have consistently low NO_x emission on roads with a speed limit of 70 to 100 km/h.

3.1.1 *Results of PTI test*

As of July 2022, a new test will become mandatory in the Netherlands during the Periodic Technical Inspection (PTI), in the Netherlands referred to as 'APK'. This test is related to the number of particles of diesel vehicles, with the aim to detect defective or removed particulate filters. With all vehicles in this test programme the required test for the APK was performed. None of the vehicles showed an exceedance of the prescribed limit.

3.2 **Cold engine start emissions; the remaining emission source, beyond 2030**

3.2.1 *Worst case: cold engine start at full engine load*

During a cold engine start the exhaust aftertreatment system is not converting pollutant emissions since it is not yet on operating temperature. At full engine load directly after a cold start, the engine out exhaust emissions are very high, and the exhaust aftertreatment system is not able to convert pollutant emissions until it reaches its operating temperature. In this test programme a worst-case situation is simulated by testing a vehicle with a cold engine start at high engine loads.

The cold start full engine load test conditions were as follows: extra mass was added to the vehicle to reach its maximum payload capacity. Then, the vehicle was parked close to an insertion lane at a gas station along the motorway and cooled down for at least six hours. After starting the cold engine, the vehicle immediately accelerated with wide open throttle onto the motorway, up to the maximum permissible speed of 100 km/h. After this wide-open throttle acceleration, the vehicle kept driving on the motorway for approximately 56 kilometers. During this motorway trip, multiple wide-open throttle accelerations were performed from 80 to 100 km/h. The complete test was then repeated two times, but with a warmer engine. This is further explained in paragraph 3.4.

Figure 3.3 shows for the three Euro 6d diesel vehicles the cumulative NO_x emission results of the full load cold start trip. The figure shows that the cold start is complete within between 0.8 and 1.5 kilometers (red-dotted vertical lines), depending on the vehicle. Moreover, within the cold start period the vehicles emit up to 93% of the total trip NO_x emissions, despite multiple wide-open throttle accelerations on the motorway after the cold start period. The emissions associated with the cold engine start of the Volkswagen Caddy are with approximately 800 mg significantly lower than those of the Peugeot Expert (approx. 2200 mg) or the Citroën Berlingo (approx. 1500 mg). The Caddy and the Berlingo are of the same vehicle category (N1-II), with the same emission limits. The Expert is a N1-III vehicle with a 20% higher emission limit, see Table 2-2. Nevertheless, under these starting conditions, the Expert needs a trip of approximately 13 kilometers to comply with the emission limit of 179 mg/km.

All vehicles perform well on NO_x emissions when the engine is warm. These tests point out that cold start events are the main remaining source of NO_x emissions.

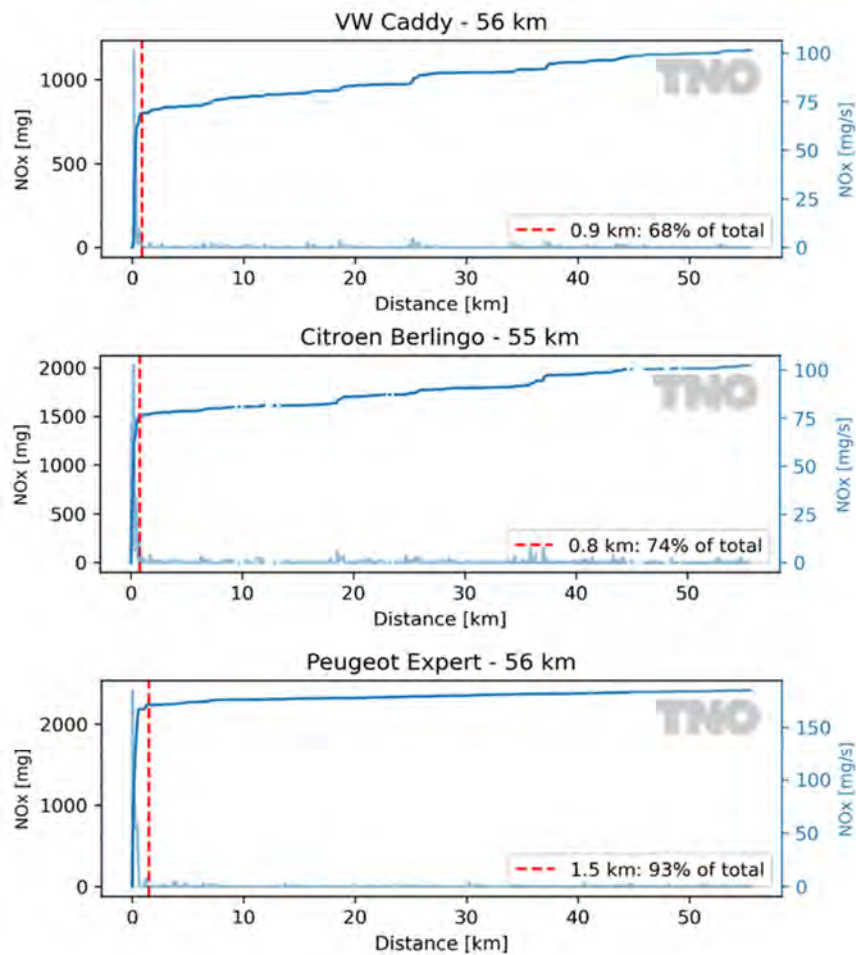

Figure 3.3: NO_x emissions during a full engine load cold start trip of three diesel- and one petrol Euro 6d vehicle(s). The red dotted line indicates the point where the exhaust aftertreatment system is working well. These cold start distances show that in the first few hundred meters more than 68% of the total trip NO_x emissions are emitted for the three diesel vehicles.

3.2.2 The role of preconditioning

The conditions prior to a cold engine start trip have an influence on the magnitude of the cold start emissions. If a diesel vehicle with an SCR catalyst has been idling for a long time the catalyst will become 'empty', i.e., due to the low SCR temperature, no urea reagent is injected anymore. The remaining urea in the catalyst will react until the catalyst temperature is too low. At a cold engine start the SCR system must be on operating temperature in order to start the reduction process. During a cold engine start with 'full' catalyst the reduction process can start quicker since urea is already present in the catalyst. During a cold engine start with 'empty' catalyst it takes longer to initiate the reduction process because the urea injection only starts when a minimum operating temperature is reached. Therefore, the cold engine start NO_x emissions of a long idling-preconditioned vehicle are higher compared to a cold engine start without long idling-preconditioning.

3.2.3 Emission results, fractions of total emissions

During emission monitoring of the three diesel vehicles, at least 148 cold start events have occurred. This data is gathered mainly over 'normal' driving, i.e., taking part in real-world traffic without specific test instructions. Figure 3.4 shows that the contribution of the cold start NO_x emissions to the total trip emissions is considerably more than 50% for the majority of the trips. This holds true for short trips of 10 kilometers or less, but also for a large part of the longer trips. On average 70% of the total trip NO_x emissions is emitted during the first 1.4 kilometers of the cold start trip. This confirms that the NO_x emissions associated with a cold engine start are dominant in the NO_x emission performance of modern diesel vehicles.

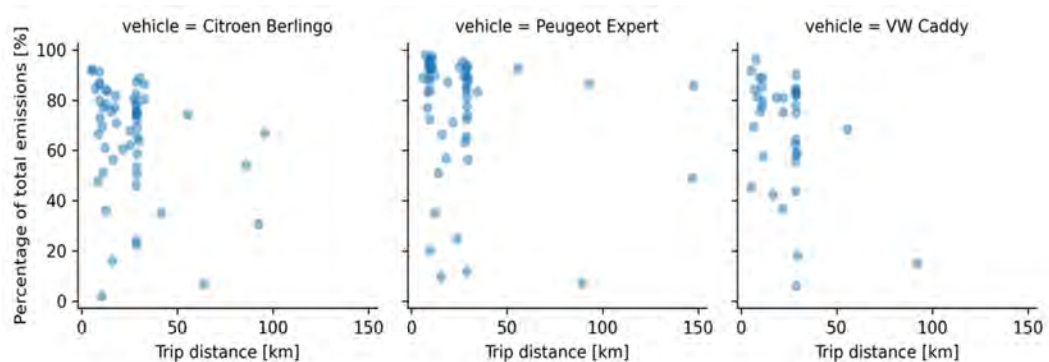

Figure 3.4: Cold start NO_x emission of three Euro 6d diesel vehicles as a percentage of the total trip emission as a function of trip distance. Each dot represents a single cold start trip.

In Figure 3.5 the NO_x emissions associated with a cold engine start (in the figures this is referred to as 'cold start offset NO_x ') are shown in milligrams as function of the CO_2 emissions. On average the cold engine start is responsible for 614 milligrams of NO_x emission, however, this can vary per vehicle: the average cold engine start emissions of the Volkswagen Caddy count for 373 milligrams while the cold start NO_x emissions of the Peugeot Expert and the Citroën Berlingo are respectively 661 and 718 milligrams. The CO_2 emissions can be seen as a proxy for applied engine load. In general, the NO_x emissions during a cold start period are higher at a higher engine load. However, this is not by definition the case and the effect of engine load differs from vehicle to vehicle.

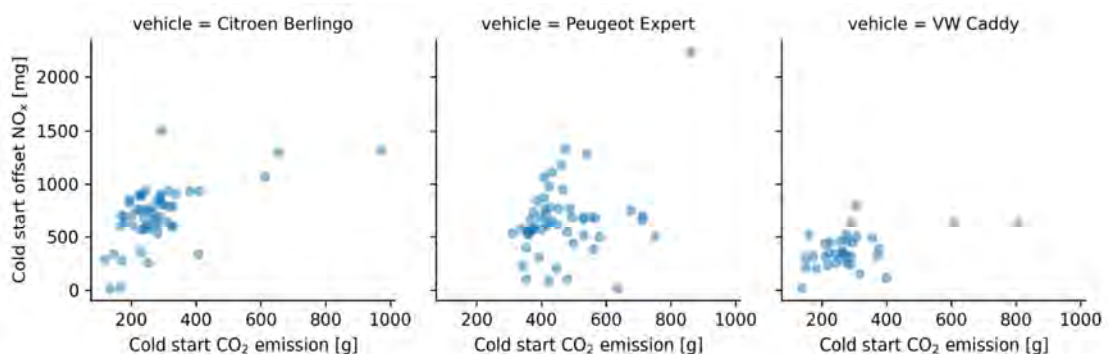

Figure 3.5: Cold start NO_x emission of three Euro 6d diesel vehicles in relation to the cold start CO_2 emissions. Each dot represents the result of a single cold start.

3.2.4 *Comparison with petrol*

Emission behavior of the Euro 6d Peugeot 108 petrol vehicle was measured with PEMS. The application of PEMS does not allow for emission monitoring over a longer period, as was the case for the diesel vehicles. However, with the PEMS equipment, unlike with SEMS, also CO, THC and PN emissions are measured. In total nine cold start trips were performed with this vehicle. Figure 3.6 shows both the cold start NO_x, THC and CO emission share of the total trip emissions (left) and the cold start NO_x, THC and CO emissions in milligrams per trip (right). In these graphs, the scale of the y-axis has been kept the same as in Figure 3.5. This clearly shows that this petrol vehicle has substantial lower NO_x emissions associated with a cold engine start than the tested diesel vehicles. Moreover, the duration of the cold start period is shorter for the petrol vehicle. For this petrol vehicle, on average 37% of the total trip NO_x emissions are emitted during the first 160 meters. On average 47% of the total trip CO emissions are emitted during the first 690 meters and on average 76% of the total trip THC emissions are emitted during the first 400 meters.

Clearly, the share of emissions during the cold engine period depends on the length of the trip. During this cold start period the average NO_x emission is 140 milligrams, which is significantly lower compared to the diesel vehicles. However, this vehicle was equipped with a PEMS which weighs 145 kilograms. The extra payload typically results in increased engine load which allow the exhaust aftertreatment system to heat up quicker, thus shortening the cold start phase.

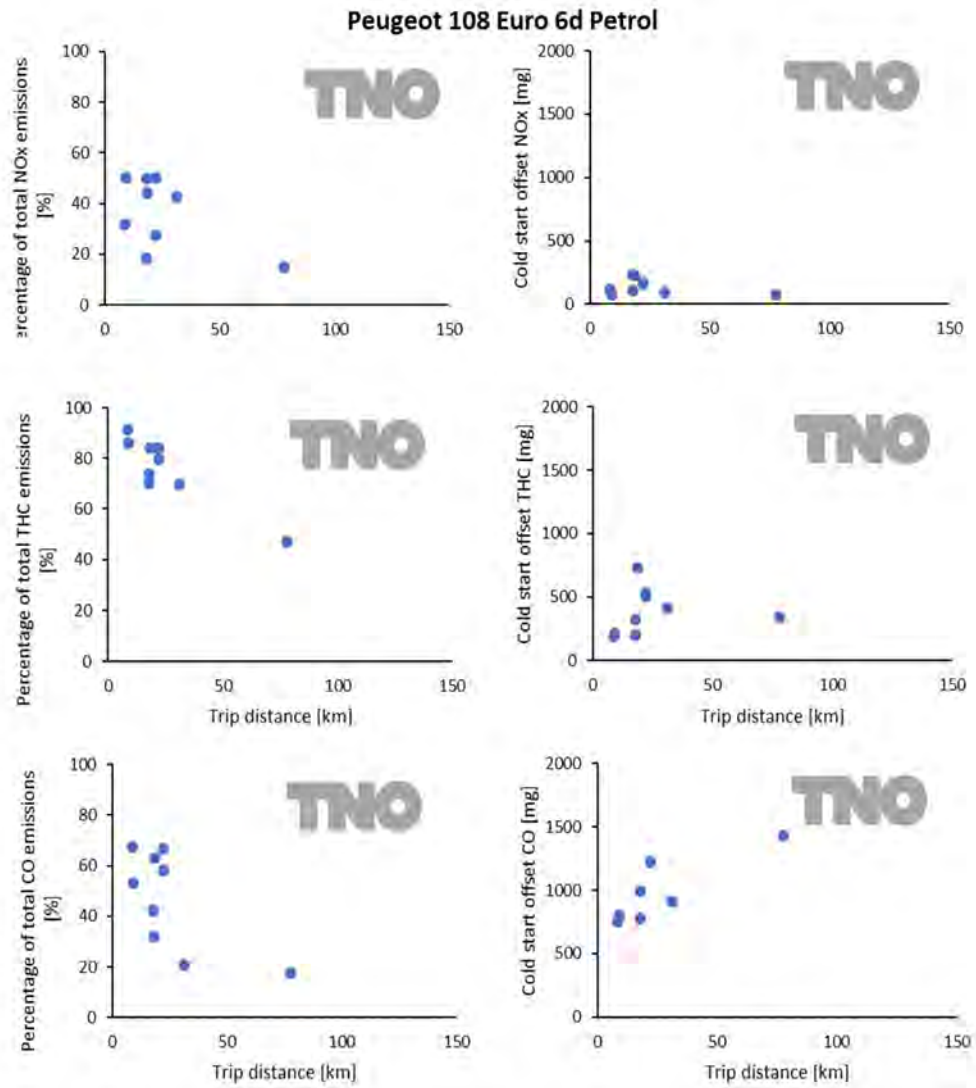

Figure 3.6: Cold start NO_x, THC and CO emissions of an Euro 6d Peugeot 108 petrol as a percentage (left) of the total trip emission for varying trip distances and absolute cold start NO_x, THC and CO emissions (right) in relation to their trip distance. Each dot represents a single cold start trip.

3.3 Keeping the catalyst warm and buffering during idling

3.3.1 Driving after prolonged idling

As already explained in paragraph 3.2.2 prolonged idling influences the urea buffer in the SCR catalyst of diesel vehicles. Long idling will result in an 'empty' catalyst. If the vehicle starts driving after idling the (empty) catalyst is less able to reduce emissions since it lacks its reagent: urea. A possible case of this effect is shown in Figure 3.7. During idling the emissions start to increase after a certain period. When the vehicle starts driving there is an emission peak. After approximately 100 seconds driving the catalyst is able again to reduce the emissions.

3.3.2 Prolonged idling in normal use

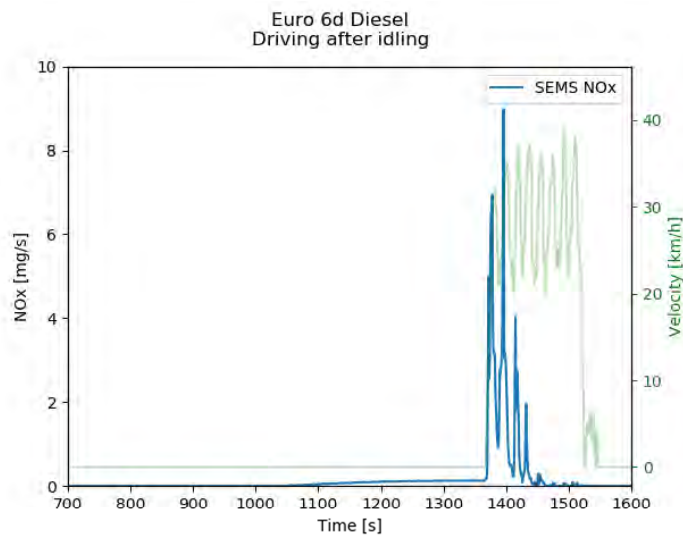

Figure 3.7: The NO_x emissions increase after a period of idling. When driving after idling there is a NO_x emission peak which the empty catalyst is unable to reduce.

In normal use of vehicles, long idling events are not uncommon. Taxi's idle while waiting for passengers, vehicles queuing in traffic accidents, and vehicles waiting for open bridges are examples of prolonged idling events that result in additional NO_x emission. Especially for diesel vehicles with an SCR catalyst, a long idling event may affect the NO_x performance, due to decreasing catalyst temperature and/or empty catalyst.

In the measurement programme, long idling events have been performed to study the emission performance of the Euro 6d vehicles. The long idling events are defined as situations where vehicle speed is less than 5 km/h for at least 5 minutes at idle engine speed. Any idling events that involves an increase in the engine speed are not considered for this analysis.

An overview of the NO_x emissions during idling from the Euro 6d diesel vehicles are shown in Figure 3.8. The vertical red-dashed line marks the 5 minutes idling time. In general, it is observed that prolonged idling events resulted in NO_x emission stabilising towards 0.5 – 1.0 mg/s. Each vehicle showcases distinct behaviour that may be affected by the catalyst configuration or engine control strategy.

For the Volkswagen Caddy, NO_x emissions bump near the 200 seconds mark resulted in instantaneous NO_x flow up to 2.5 mg/s. Steady state NO_x after prolonged idling is observed to vary between 0.1 to 1.0 mg/s. It is also observed (not shown in Figure 3.4) that this vehicle may start idling at higher engine speed around 980 RPM, before slowly transitioning to idle engine speed of 880 RPM. It is not clear what the correlation is between the idling engine speed behaviour and the catalyst configurations.

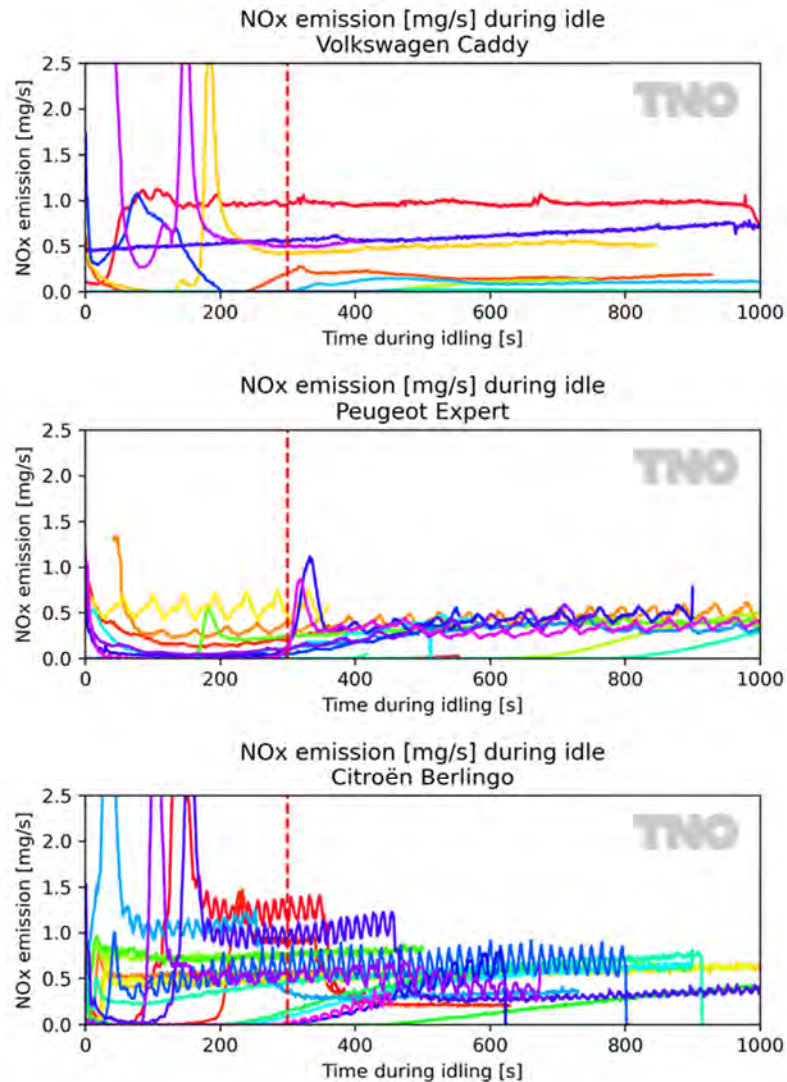

Figure 3.8: NO_x emissions during (long) idle engine operation of three Euro 6d diesel vehicles. Each coloured line represents an idling session.

For the Peugeot Expert, in some cases a NO_x emission spike is observed after 5-minute mark before decreasing steadily around 0.5 mg/s. Furthermore, fluctuating NO_x emission is observed, which seems to be attributed by the fluctuating engine speed during idling. Whether this oscillation behaviour is caused by engine control or vehicle limitations cannot be determined from the current dataset.

For the Citroën Berlingo, a NO_x emission spike is observed around 180 seconds mark before fluctuating steadily around 0.5 mg/s. Like the Peugeot Expert, fluctuation in NO_x emission is observed, but with a higher frequency.

3.3.3 *Emission results*

As demonstrated in Figure 3.8 the NO_x emissions during prolonged idling stabilizes between 0.1 and 1.0 mg/s, depending on the vehicle and/or engine strategy. To put the 1.0 mg/s NO_x emission in broader perspective: if a vehicle would drive 25 km/h while it emits NO_x at a rate of 1.0 mg/s, the NO_x emission is 144 mg/km. After 15 minutes of idling, 1 mg/s would result in 900 mg of NO_x.

3.3.4 *Limitations in RDE*

The RDE trip requirements describe an idling time limit of 300 seconds (In Figure 3.8 the red dotted vertical line). For multiple idling events the elevation of NO_x emissions starts after 300 seconds. This applies to all three vehicles but in particular for the Peugeot Expert and the Citroën Berlingo. It is not clear why it does not apply to all idling sessions. A possible explanation can be the link with conditions prior to the idling event and engine strategy.

3.3.5 *Comparison with petrol*

With the Euro 6d Peugeot 108 petrol, equipped with PEMS, also idle tests were performed. The results are shown in Figure 3.9. The NO_x emissions of this vehicle during idling are negligible. However, an increase in CO, THC and PN emissions is visible. After approximately 200 seconds, the CO emission increases and stabilizes to an average of 0.4 mg/s which corresponds to 57.6 mg/km when driving 25 km/h. This is well below the emission limit of 1,000 mg/km.

From warm engine start the THC emission is dropping in 150 seconds from 0.07 to 0.01 mg/s but gradually increases to around 0.06 mg/s. The cold engine start THC emissions of this vehicle are typically between 0.5 and 0.9 mg/s. Over the prolonged idling after the warm engine start, the average THC emission is 0.03 mg/s which corresponds to 4.32 mg/km when driving 25 km/h. The emission limit for this emission component is 100 mg/km.

The PN emission gradually increases from 1×10^6 #/s and stabilizes to 3×10^6 #/s after 350 seconds. When driving 25 km/h this would correspond to 4.3×10^8 #/km. The Euro 6 limit for PN is 6.0×10^{11} .

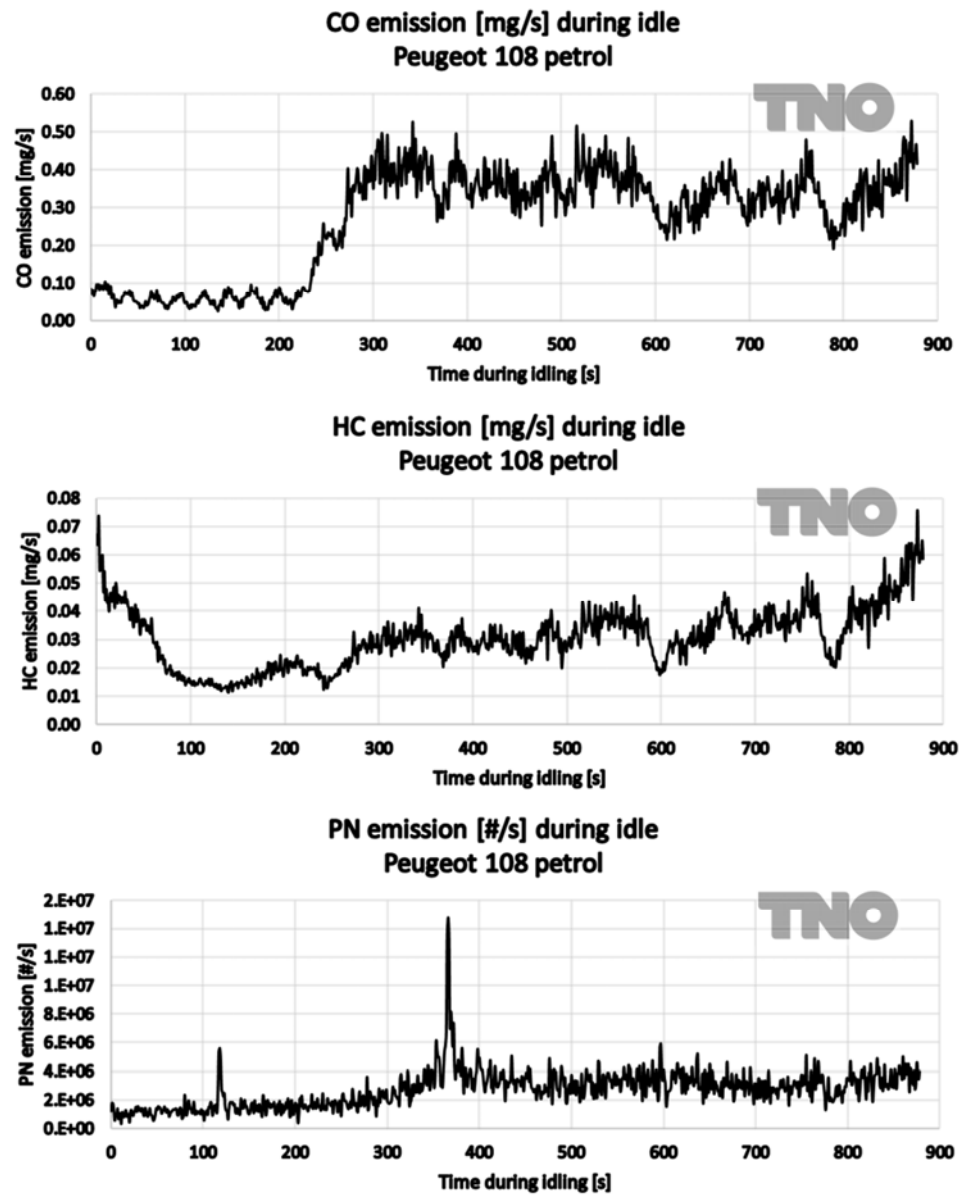

Figure 3.9: CO, HC and PN emissions during (long) idle engine operation of a Peugeot 108 Euro 6d petrol vehicle.

3.4 High engine load; not the main issue for NO_x emissions

3.4.1 Highest power demand

The cold start full load tests as described in paragraph 3.2.1 consist of three repetitions. First, the test was performed with a cold engine. Then, the complete test was repeated, but with a warm engine. The cold full load acceleration resulted in a high increase in emissions. The second and third full load events with a hot engine resulted only in minor increase of the total NO_x emissions.

The high power demand events with a hot engine are not a main source of elevated emissions for the tested diesel vehicles.

During high power demand events the petrol vehicle has CO emission spikes of approximately 5 mg/s. There is no significant increase in NO_x and HC emissions during high power demands when the engine and aftertreatment system reached their operating temperature.

3.4.2 *NO_x per CO₂*

The engine power demand is directly related to CO₂ mass flow. At high engine power the CO₂ mass flow will also be high. This does not necessarily hold true for the NO_x emissions. Figure 3.10 demonstrates that the NO_x emission in milligrams per second is not unambiguously increasing at higher CO₂ mass flows (power). Elevated emissions occur over the complete range of CO₂ mass flows. Only at the highest end of the mass flow range, i.e. after 8 g/s, a more significant increase in NO_x emissions can be observed. Nevertheless, high engine load for this vehicle is not the main source of elevated NO_x emissions as long as the system has reached operating temperature.

3.4.3 *Driving behavior*

Figure 3.10 displays the NO_x emission in relation to dynamic driving for the four test vehicles. Dynamic driving is shown as $v \cdot a_{\text{pos}}$ on the x-axis. The $v \cdot a_{\text{pos}}$ measure for dynamic driving is a multiplication of velocity (v) and positive acceleration (a_{pos}). The corresponding NO_x emission is shown on the y-axis in mg/s for the left plots. On the right picture of the two figures per vehicle, the y-axis represents the count of seconds as function of dynamic driving (shown as 'mean va bin'). This plot shows for real-world driving the likelihood of occurrence of these dynamic driving values. The diesel vehicles show an increase in NO_x emissions at higher levels of dynamic driving, which also includes higher engine loads. The range of the NO_x increase is very different per vehicle. The Volkswagen Caddy shows an increase of approximately 2 mg/s, while the Peugeot Expert and the Citroën Berlingo show a NO_x emission increase of respectively approximately 10 and 4 mg/s at high dynamic driving. The Peugeot 108 petrol vehicle does not show this increase of NO_x emission during more dynamic driving. Moreover, the gradient of the increase differs per vehicle. The VW Caddy and the Citroen Berlingo show the largest increase in emissions between a $v \cdot a_{\text{pos}}$ of 10 and 20 m²/s³, while the Peugeot Experts keeps increasing up to 30 m²/s³. At the same time, the higher the $v \cdot a_{\text{pos}}$ bin, the lesser it occurs during real-world driving.

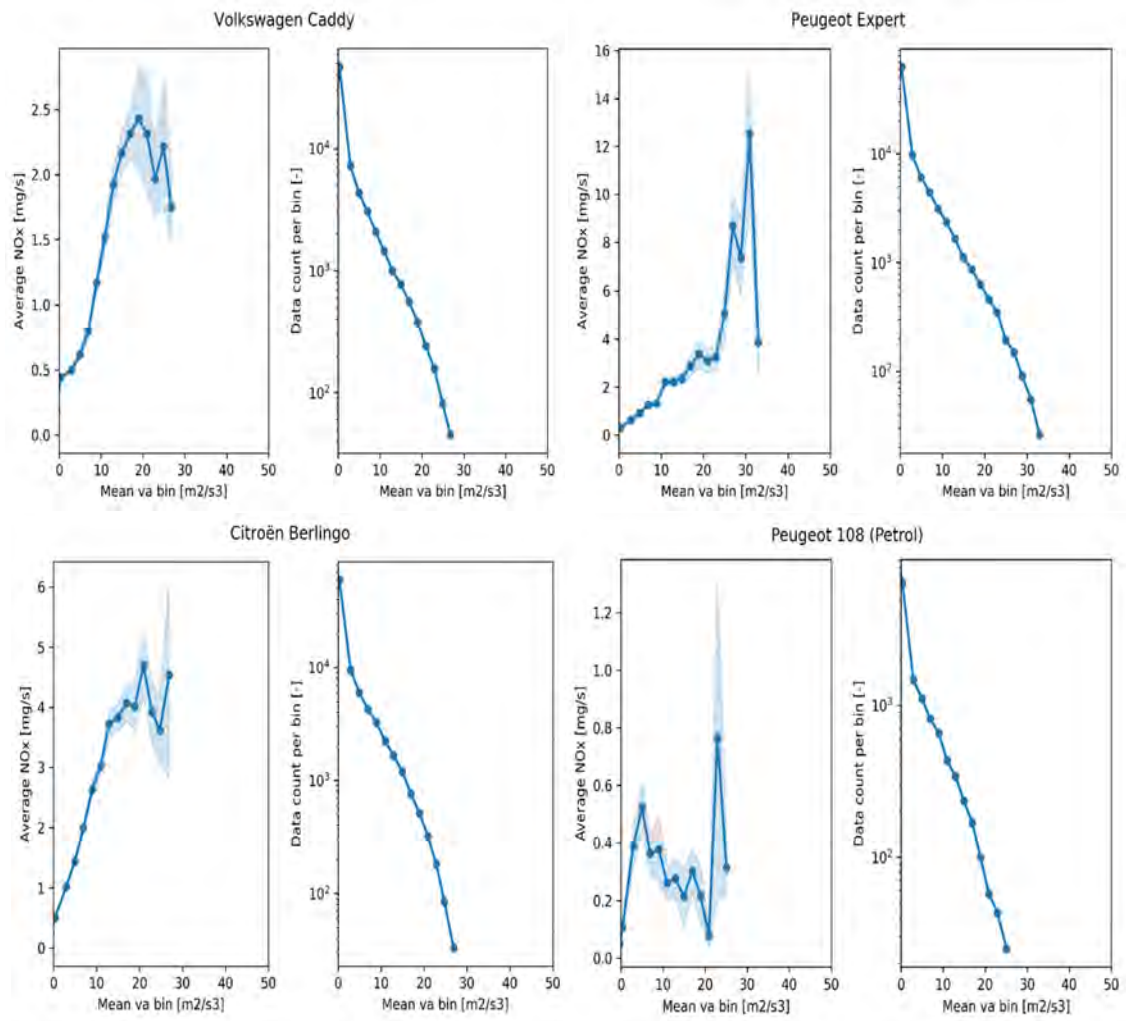

Figure 3.10: Relation between dynamic driving and average NO_x emissions for three Euro 6d diesel vehicles and one petrol vehicle.

3.4.4 Power demand restriction in RDE

During the on-road emission monitoring of the three Euro 6d diesel vehicles a wide range of engine operation was covered. The engine power demand during RDE trips, only cover a certain area of the engine operating range due to the v^*a_{pos} limits. As an example, Figure 3.11 shows the emission map of the Euro 6d Citroën Berlingo, for the monitoring data (left) and the driven RDE trip (right). The upper graphs show the average NO_x emission dependent on the engine operation, described as CO₂ mass flow as a function of engine speed. As mentioned before, the CO₂ mass flow is directly related to the engine power. The upper right graph shows that for the Citroën Berlingo the RDE trip only covers CO₂ mass flow up to 6 grams per second, while during on-road monitoring the CO₂ mass flow can go up to more than 10 grams per second, this where the NO_x emissions are highest for this vehicle.

For this vehicle the average NO_x emissions of the RDE trip and monitoring are respectively 6.9 and 46.3 milligrams per kilometre. This difference can partly be explained by the difference in power demand.

The bottom graphs show the count of datapoints per engine operation point. The left bottom graph shows that CO₂ mass flows higher than 6 grams per second are not rare during real world driving. During on-road emission monitoring the vehicle is mainly driving in 'normal conditions' i.e. driving along with the traffic flow with no varying payload. The monitoring data includes trips with 55% payload, 95% payload and one trip with full load acceleration.

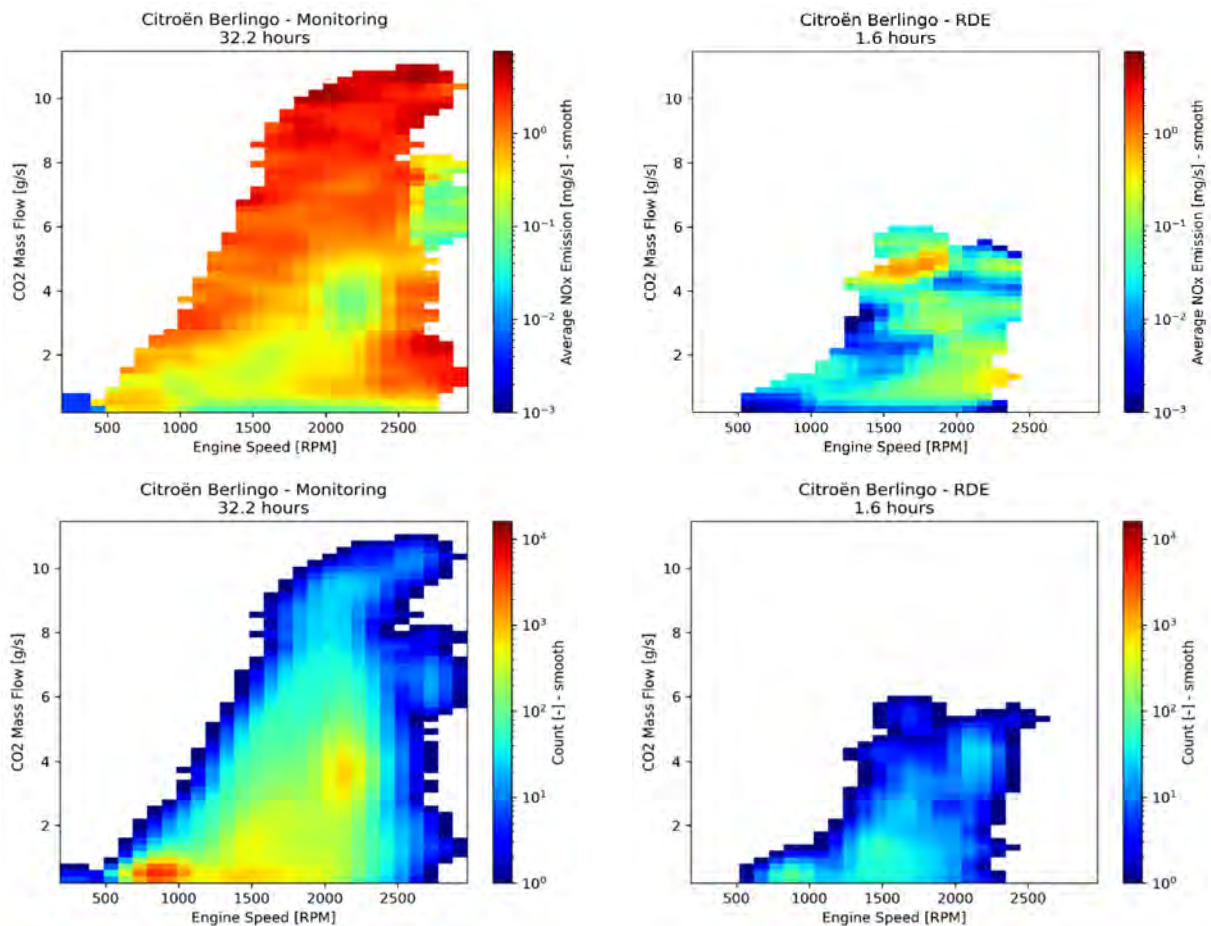

Figure 3.11: Emission map of a Euro 6d diesel vehicle. The upper figures show coverage of engine operation during 32.2 hours of on-road emission monitoring (left) and a RDE trip (right) of the Euro 6d diesel Citroën Berlingo. The bottom figures show the count of occurrences in certain engine operating points. Emission maps of the Peugeot Expert and the Volkswagen Caddy are given in Appendix C.

This phenomenon has a bigger effect with high powered vehicles. The higher the engine power of the vehicle, the smaller the engine power coverage in the RDE trip.

On the x-axis of Figure 3.10 in the previous paragraph the unit for dynamic driving ($v \cdot a_{\text{pos}}$ [m^2/s^3]) is shown. The figures demonstrate the relation between dynamic driving and average NO_x emissions, using the emission monitoring data.

All three diesel vehicles crossed the RDE boundaries for dynamic driving during monitoring multiple times. Therefore, the RDE boundary does not cover the whole range of dynamic driving during monitoring.

3.4.5 *Future legislation, Euro-7*

The emission performance of the tested vehicles is very good. Moreover, before this testing programme, TNO has been testing both the Euro-6d-Temp vehicles (see also TNO report 2020 R12024, Emissions of five Euro 6d-Temp Light Duty diesel vehicles), and more recently Euro-6d vehicles. Moreover, TNO is involved in various international measurement campaigns where the emissions performance of such modern vehicles is tested. The emission performance of these modern vehicles is very good, a major improvement over the previous generations Euro-6 vehicles, which had to satisfy the same limit, but not in on-road emission tests. Clearly, the actual details of testing make a large difference in the emission performance. Moreover, the step from Euro-6d-Temp to Euro-6d is a further significant improvement in emissions. If these levels are maintained in the newer generations of diesel vehicles, and over their lifetime, their relevance for air-quality problems is decimated, from the Euro-5, or diesel scandal, levels.

A few of the outstanding issues with Euro-6d diesel NO_x emissions are the coverage of the on-road RDE trips and the lifetime emission with maintenance and tampering issues. Both prolonged idling and hard accelerations are excluded from the RDE trip. It is observed that a number of vehicles have much higher emissions in these situations than otherwise in normal use. Vehicles seem optimized for good RDE performance, with limited robustness for other driving situations. Moreover, cold start emissions have a limited contribution in the overall RDE test result that is compared with the limit. In the Advisory Group on Vehicle Emissions Standards these issues were raised, and the current proposal is to reduce the test boundary, and allow any trip to be a valid test for evaluation against the emission legislation. The Commission proposal for Euro-7 legislation is expected mid 2022, and likely this recommendation is included, extending the emission testing, and limited further the few cases in which high emissions are accepted.

4. NO_x monitoring, based on in-vehicle signals

Both Euro 6d light-duty and heavy-duty diesel vehicles are equipped with a SCR system, including NO_x sensors for closed-loop SCR control. Besides SCR control, these NO_x sensors can provide information with regard to the NO_x emission performance of those vehicles. In this chapter the possibilities for (online) NO_x monitoring bases on in-vehicle signals are elaborated in more detail.

4.1 Online NO_x monitoring

It becomes more and more common that modern vehicles are wireless connected with a server of the vehicle manufacturer for data transmission and data storage. For vehicle manufacturers this can provide valuable information, for example about maintenance status, malfunctions and the fuel consumption in real-world circumstances. Connected vehicles are potentially interesting to learn more about real-world NO_x emissions if the information of the NO_x sensors become available for an online NO_x monitoring. For this project several light-duty vehicle manufacturers and importers like Renault, PON, BMW, Mazda and Volvo were interviewed to find out if over-the-air (OTA) monitoring of the NO_x sensors is applied. All parties explained that no OTA NO_x monitoring is applied on their light-duty vehicles. Therefore, the focus of this subject in the project was shifted to the in-vehicle NO_x signals on the OBD port. These NO_x signals can be monitored with a separated data logger connected to the OBD port.

4.2 Availability and reliability

4.2.1 *Background of communication with NO_x sensor*

The Society of Automotive Engineers (SAE) has setup a document that is concerned with emissions related diagnostic services: 'SAE J1979'. This J1979 protocol document contains details of all standardized data items such as the in-vehicle NO_x sensor, which can be read via an OBD port connection if the manufacturer chooses to make this signal available.

If the in-vehicle NO_x sensor signal is not available on the OBD port, another option to monitor this signal is via a contactless inductive sensor which reads the 'raw' serial communication between the NO_x sensor and the vehicle's electronic control unit (ECU). This is not a plug-and-play method since it requires knowledge about how to interpret the serial communication, which can be different for each vehicle. A vehicle- and sensor specific DBC-file (Database Container) is required to be able to convert the raw communication to useful measured NO_x concentrations. Thus, reading the NO_x sensor signals this way is more cumbersome than reading them via the OBD port.

If the in-vehicle NO_x signal is available on the OBD port (following J1979 protocol), there can be multiple parameters that originate from the same in-vehicle NO_x sensor. The J1979 protocol describes both uncorrected and corrected signals. The latter is defined as "*a value that includes learned adaptations and offsets that are used to adjust the raw signal*". These learned adaptations and applied offsets are unknown. In this measurement campaign only uncorrected NO_x signals were found. No corrected NO_x signals were available at any of the tested vehicles.

4.2.2 Availability of the NO_x signal at the tested vehicles

Table 4-1 below shows an overview of the available signals for the tested vehicles in this measurement campaign.

The uncorrected OBD NO_x values were available at the Volkswagen Caddy, Citroën Berlingo, Peugeot Expert. Next to the tested vehicles in this measurement campaign, monitoring data of earlier tested vehicles were checked on the availability of NO_x signals. This inventory showed that the uncorrected NO_x signal was available at the Skoda Octavia (Euro 6d-TEMP) as well.

For the Peugeot Expert and the Citroën Berlingo, it was not possible to log the raw NO_x signal via the contactless inductive sensor because of the lack of DBC files. For the Volkswagen Caddy the DBC was like TNO's SEMS NO_x sensor. Therefore, it was possible to translate this raw signal to human readable NO_x concentrations.

It is however not always directly clear if NO_x data is available, as the signal only show values after a certain time (see next paragraph).

Table 4-1: Available NO_x sensor signals of Euro 6d (-TEMP) vehicles.

Vehicle	Uncorrected OBD NO _x	Corrected OBD NO _x	RAW CAN-bus NO _x	Remark
Volkswagen Caddy	Yes	No	Yes	DBC information available.
Citroen Berlingo	Yes	No	No	
Peugeot Expert	Yes	No	No	
Peugeot 108	No	No	No	No NO _x sensor (petrol vehicle).
Skoda Octavia*	Yes	No	No	Euro 6d TEMP

*Tested in a previous emission test program.

4.2.3 Reliability of the NO_x signal at the tested vehicles

The monitoring data shows that all the in-vehicle NO_x sensor signals of the vehicles in this program are inactive at the start of a trip. It's likely that the sensors start measuring when certain desired conditions are met. However, it's unclear which parameters play a role in triggering the sensor to start measuring. There were no indications that the exhaust gas temperature and engine coolant temperature trigger the start of the sensor. No specific threshold values were found where the sensor starts measuring. In none of the trips it was possible to log OBD NO_x during the cold start because it took too long for the NO_x signal to become 'active'. This will be elaborated in paragraph 4.3.

Another aspect regarding reliability is related to the position of the in-vehicle NO_x sensor. Figure 4.1 demonstrates where the positions of the in-vehicle NO_x sensors are in relation to the exhaust aftertreatment systems for the three tested vehicles. DOC is the abbreviation for 'diesel oxidation catalyst' and ASC is the abbreviation for 'ammonia slip catalyst'.

The figure also shows where TNO's SEMS NO_x sensor, NH₃ sensor and thermocouple are installed to measure tailpipe-out emissions (after the catalyst(s), on the right side in Figure 4.1). To determine which NO_x-sensor belongs to which signal on the OBD, each sensor has been unplugged for a few seconds to see which signal disappears. Note that for the Volkswagen Caddy and the Peugeot Expert the order is 'NOX_11', 'NOX_12' (and 'NOX_13'), while the order of the Citroën Berlingo is the opposite. It is therefore not directly clear where the NO_x sensors are located. If the in-vehicle NO_x sensor will be used to determine NO_x emissions, it is important to know where the NO_x is actually measured in the exhaust system.

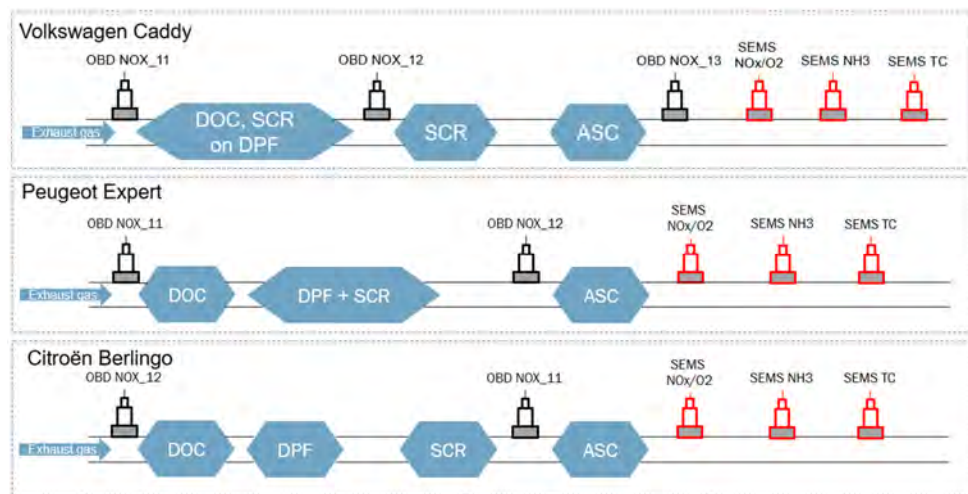

Figure 4.1: Schematic overview of the position of catalysts, in-vehicle NO_x sensors and installed SEMS sensors (in red) in the exhaust pipes of the three tested Euro 6d diesel vehicles. For each vehicle the in-vehicle NO_x sensors (named 'OBD NOX_1x') have a different position in the exhaust pipe. Only the in-vehicle NO_x sensor ('OBD NOX_13') of the Volkswagen Caddy is measuring actual tailpipe-out NO_x emissions.

For tailpipe-out NO_x emission monitoring only the Volkswagen Caddy is a suitable candidate since 'OBD NOX_13' is located after all the exhaust aftertreatment systems. The Peugeot Expert and the Citroën Berlingo only have engine-out- and pre-ASC (Ammonia Slip Catalyst) in-vehicle NO_x sensors and therefore do not measure tailpipe-out NO_x emissions. In the ASC Ammonia is oxidized (1) which leads, among others to the formation of NO. Therefore, pre-ASC located NO_x sensors will measure different NO_x concentrations than what is emitted from the tailpipe. Moreover, the NO_x sensors have cross-sensitivity with ammonia. This will result in an overestimation of the actual NO_x concentration, caused by ammonia.

The above shows that it is very important to know the exact sensor configuration for each vehicle, otherwise it is unclear by which NO_x-signal the tailpipe-out NO_x emission is represented.

4.3 Comparison with SEMS measurement results

4.3.1 Warm-up and default values of the NO_x sensors

The NO_x sensors which are installed in diesel vehicles with SCR have to warm up before they can start measuring. With the TNO SEMS, the warmup of the sensor element typically takes no more than 80 seconds after the sensor is turned on. Figure 4.2 shows for the Volkswagen Caddy on the left side the distribution of startup times of the NO_x signal on the OBD port, measured in 51 trips.

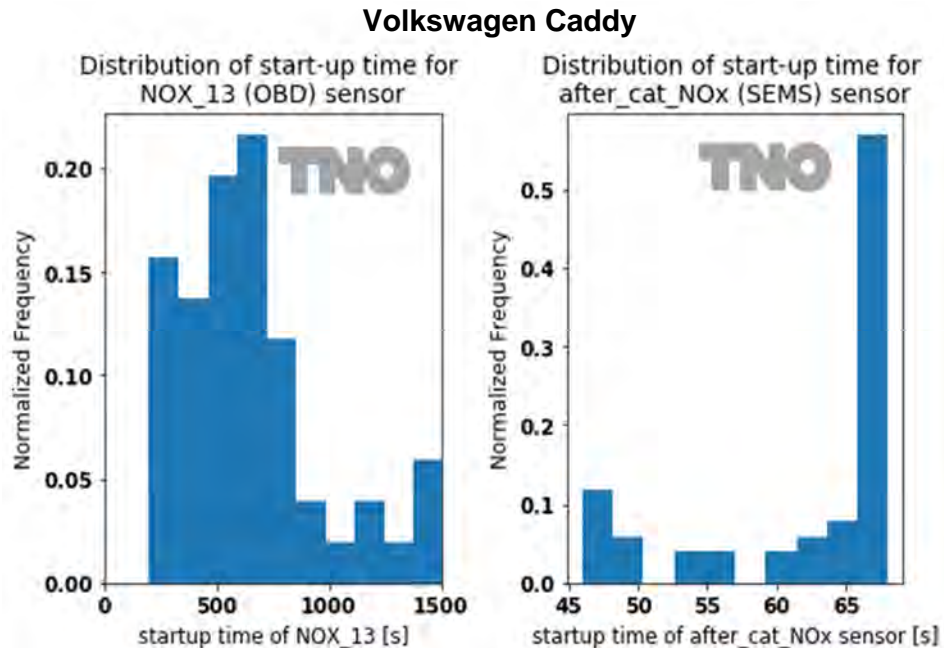

Figure 4.2: Monitoring data of the Euro 6d Volkswagen Caddy. On the left: distribution of start-up times of the in-vehicle NO_x (tailpipe-out). On the right: distribution of start-up times for the SEMS NO_x sensor.

This NO_x sensor is positioned at the end of the tailpipe, thus measuring the actual emitted NO_x. It's remarkable that there is such a wide distribution of startup times from 198 to 1509 seconds. In most cases the time between ignition-on and a valid NO_x sensor signal is around 600 seconds. Since the user has no control over the in-vehicle NO_x sensor it is not possible to easily accelerate the start-up time. On the right side in the figure the start-up times of the SEMS NO_x sensor are shown. For this sensor it's typically around 65 seconds after ignition-on.

During the period before the in-vehicle NO_x sensor becomes active, the transmitted default NO_x signal displays the maximum value of 65535 ppm for the Volkswagen Caddy. Figure 4.3 illustrates the part of a trip where the in-vehicle NO_x signal becomes active after approximately 1000 seconds. Then it starts to drop from 65535 ppm. From that point it takes the signal around 60 seconds to be on approximately the same level as the SEMS NO_x signal.

The OBD-II SAE J1979 standard does not indicate what the default NO_x value on the OBD port should be or when the signal should be available.

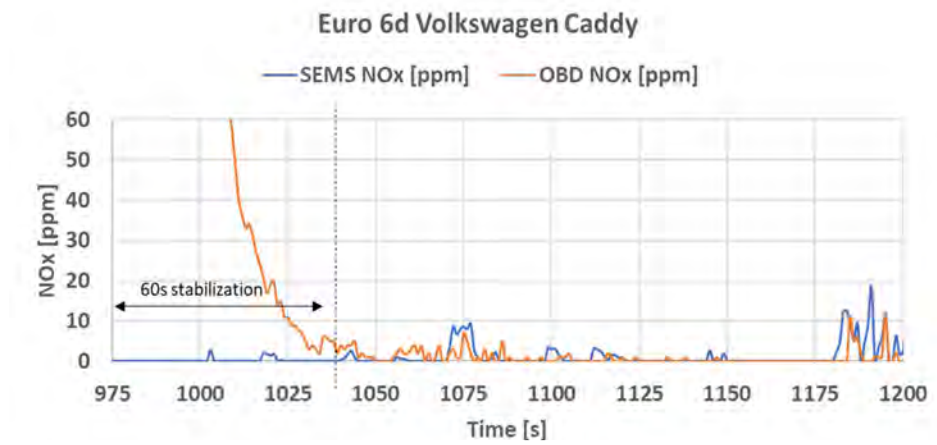

Figure 4.3: Stabilization time after activation of the OBD NO_x sensor of the Euro 6d Volkswagen Caddy.

The other two vehicles do not have a tailpipe-out NO_x sensor, as the NO_x sensors are located before the ASC. For those vehicles the sensor closest to the end of the tailpipe is selected for analysis. For the Peugeot Expert and the Citroën Berlingo these sensors are post-SCR and pre-ASC. Both these vehicles have a default in-vehicle NO_x value of 20 ppm (instead of 65535 ppm as on the Volkswagen Caddy). In contrast to the default value of 65535, a value of 20 ppm can occur during real-world driving too and is therefore more complex to detect.

Figure 4.4 and 4.5 show for all trips how many seconds it took for the Peugeot Expert's and the Citroën Berlingo's in-vehicle NO_x sensor to startup, i.e., showing another value than the default value of 20 ppm. Although most of the trips have startup times comparable to the SEMS NO_x startup time, the range is much larger. The measurement data shows that the default NO_x value can vary per vehicle.

Peugeot Expert

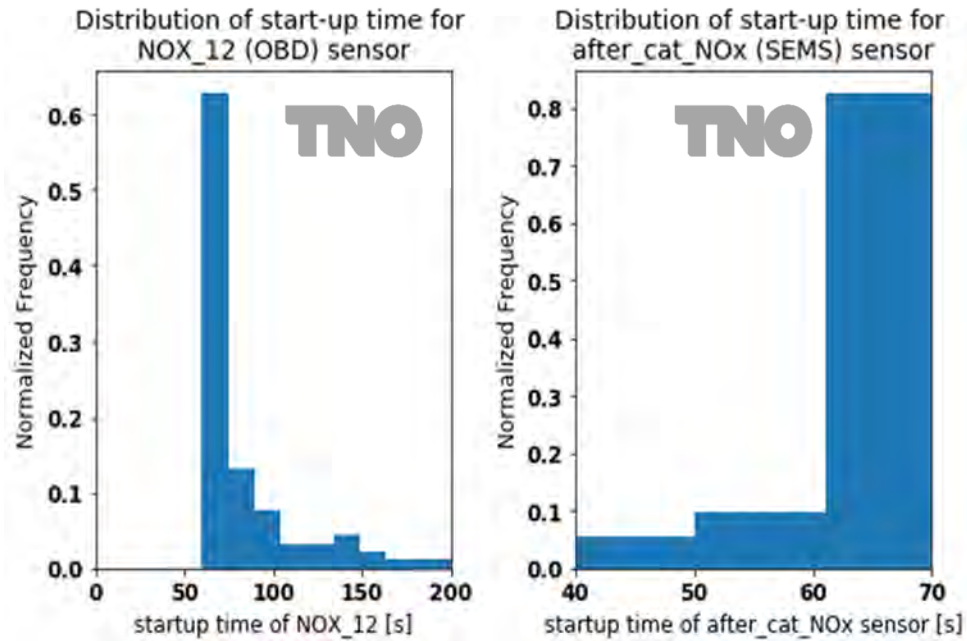

Figure 4.4: Monitoring data of the Euro 6d Peugeot Expert. On the left: distribution of start-up times of the in-vehicle NO_x sensor (pre-ASC). On the right: distribution of start-up times for the SEMS NO_x sensor.

Citroën Berlingo

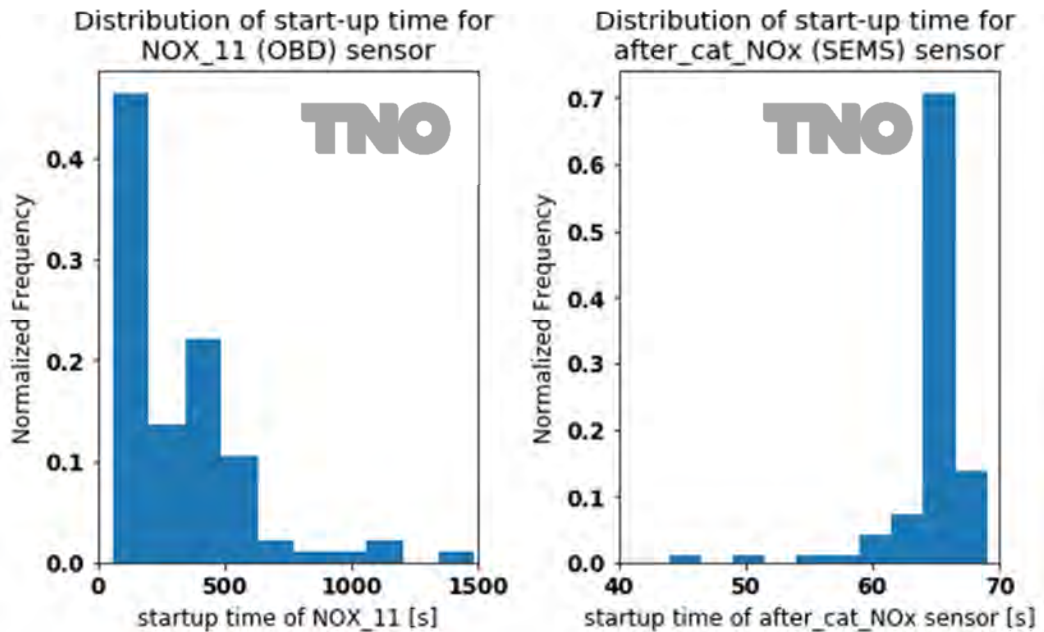

Figure 4.5: Monitoring data of the Euro 6d Citroën Berlingo. On the left: distribution of start-up times of the in-vehicle NO_x sensor (pre-ASC). On the right: distribution of start-up times for the SEMS NO_x sensor.

4.3.2 Comparison of concentration levels between OBD NO_x and SEMS

In this paragraph the measured concentration levels of the OBD NO_x are compared to the SEMS NO_x. Before this comparison could be made, data processing was applied to remove the default values (i.e., 20 ppm and 65535 ppm) and to only consider values when the NO_x sensor has started working with a stabilized signal. Moreover, unrealistically high values were removed. Furthermore, the OBD NO_x and SEMS NO_x were time aligned for the VW Caddy. For the other two vehicles, adjustments in time alignment did not lead to a better correlation.

The figure below shows the correlation between concentration levels of the OBD NO_x and SEMS NO_x for the three tested diesel vehicles. For the VW Caddy, where both sensors are located at the end of the tailpipe (after the ASC), the correlation is substantially better than for the other two vehicles. Nevertheless, also for the Caddy quite some differences can be observed. The Peugeot Expert shows in some cases a comparable correlation as for the VW Caddy. However, there also is a clear other trend visible, where the OBD NO_x shows very high concentration levels while the SEMS NO_x shows low values. The correlation between the two signals is very poor for the Citroën Berlingo.

A more detailed analysis is needed for a better understanding between the observed differences. More understanding is needed if the differences are related to specific conditions, like exhaust temperature, engine load and driving dynamics.

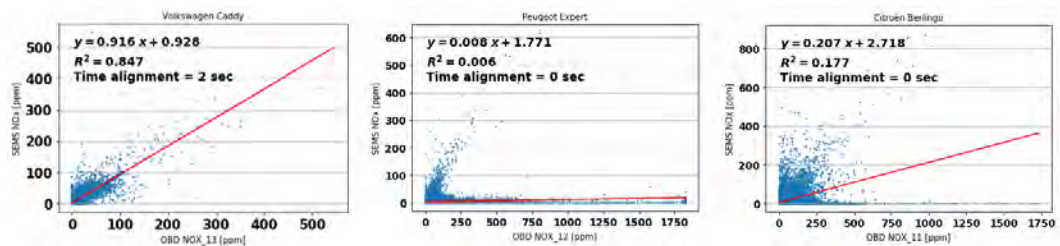

Figure 4.6: Correlation of concentration levels between OBD NO_x and SEMS

4.3.3 Emission levels based on OBD NO_x versus SEMS

The dataset of the tested Volkswagen Caddy indicates that it can take up to almost 25 minutes in order to determine the NO_x emission level through the in-vehicle NO_x sensor. Of all 90 trips there are 56 trips where it was possible to calculate the NO_x emissions in milligram per kilometer, using the in-vehicle NO_x sensor. That is when a trip contains in-vehicle NO_x sensor measurement data. In the other 34 trips the trip duration was too short for the in-vehicle NO_x sensor to become active. In the calculation the accumulated OBD NO_x is divided by the total distance over which the OBD NO_x signal was active. Clearly, when the total distance would be considered the emission levels in g/km would drop, as the sensor has a very long warm-up time.

The results show a very big range between OBD NO_x and SEMS NO_x. Compared to SEMS, the average deviation of these results is a 66% lower result, i.e. for this vehicle only 34% of the actual NO_x emissions could be detected through the in-vehicle NO_x sensor. There are also some trips with a good correlation. Two trips showed a deviation of the OBD NO_x result of less than 6%. These are trips of 90 and 94 kilometers in which the OBD NO_x was active in the majority of the trip. The 90 kilometer trip is a hot start RDE trip with an average NO_x emission of 5.2 mg/km according to SEMS and 5.0 mg/km according to the OBD NO_x calculation. The figure below shows an example of a trip where the OBD NO_x and SEMS NO_x were comparable.

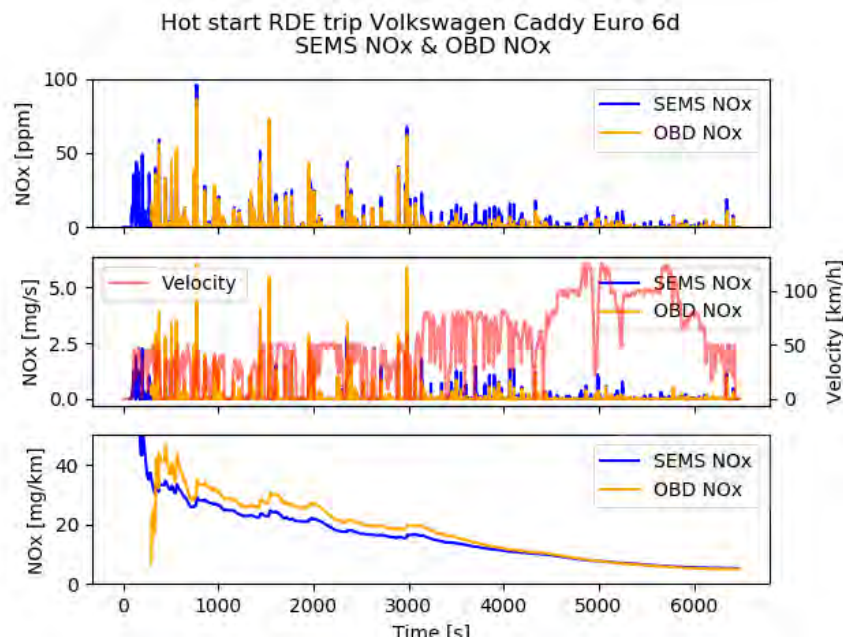

Figure 4.7: Hot start RDE trip with Volkswagen Caddy Euro 6d, SEMS NO_x versus OBD NO_x.

For the Citroën Berlingo and the Peugeot Expert the correlation of the measured NO_x concentrations of the in-vehicle NO_x sensor and the SEMS NO_x sensor is not good enough to calculate emission levels in milligrams per kilometer based on the OBD NO_x only.

As mentioned in the previous paragraph a more detailed analysis is needed for a better understanding between the observed differences.

4.4 Discussion: Emission level determination through in-vehicle signals

As discussed in paragraph 4.3 the in-vehicle NO_x sensor signal is currently often not very accurate for determining the NO_x emissions. Especially since the NO_x sensor often seems to be active only in conditions where the exhaust aftertreatment system is operating well, and the NO_x emissions are expected to be low in the general. Chapter 3 described that the cold engine start emissions are often dominant. The OBD NO_x sensor is not capable of measuring during these conditions. Therefore, NO_x monitoring via in-vehicle signals is currently not an accurate method to assess the NO_x emission performance.

Universal workshop OBD tools were not able to advance NO_x sensor activation. It is likely that manufacturers can advance the NO_x sensor activation or activate it manually. However, for now it is unclear why the in-vehicle NO_x sensors are only activated after these long time periods.

However, the sensor is suitable for detection of possible elevated emissions at certain conditions. Moreover, with a better understanding of the OBD NO_x signal, it may be possible to detect elevated emission due to a malfunction in the emission aftertreatment system. In addition, if the quality (including possible drift) of the OBD NO_x signal is known, a monitoring of average lifetime NO_x levels can possibly be monitored, for example to monitor possible deterioration of the exhaust aftertreatment system. This applies to the NO_x sensors which are positioned after the SCR catalyst. One important aspect of this approach is to also consider the deterioration or malfunctions of the NO_x sensor itself.

This detection of a malfunction in the exhaust aftertreatment system is already part of the OBD requirements as described in European Regulation 459/2012. For the Volkswagen Caddy is the OBD NO_x threshold is 180 mg/km since it's an N1 class II Euro 6d diesel vehicle. If vehicle's NO_x emission calculation exceeds the OBD threshold the driver should get a warning on the dashboard. The driver must then visit the garage to get the malfunction fixed.

In the future the OBD NO_x signal could potentially play a role during periodic inspection. However, if NO_x testing through in-vehicle signals is desired during an idle test when the periodic technical inspection is performed, it seems necessary to first drive the vehicle until the sensor becomes active. Advanced workshop OBD equipment was not able to force the in-vehicle NO_x sensor to become active on demand. Moreover, the accuracy of the in-vehicle NO_x sensor is unknown when performing a periodic technical inspection.

5. Emission factors; a new category

Emission factors are distinct for categories with distinct emission performance, technology, or vehicle type or usage. Initially, no distinction was made in TNO emission factors between diesel vehicles Euro 6d-Temp and Euro 6d. However, as shown in Figure 5.1 current results do suggest that a distinction should be made. One should note that Euro 6d-Temp is involves only a limited number of vehicles, that entered the market in 2018 and 2019.

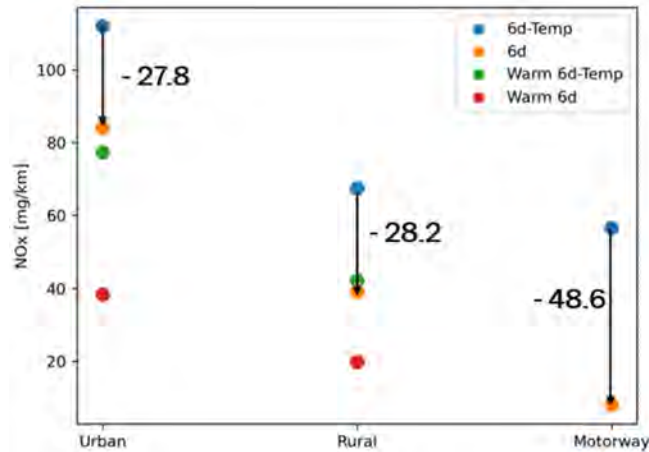

Figure 5.1: Drop in NO_x emission factors from Euro 6d-Temp to 6d diesel vehicles for urban, rural and motorway segments.

Figure 5.2 below shows the newly registered Euro 6 D (EUD6) and Euro 6D temp (EDT6) diesel vehicles per registration month. Since 1-1-2021 most newly registered diesel passenger cars (LPA) are Euro 6D vehicles. For light commercial vehicles (LBA) the largest share of newly registered diesel vehicles has still been Euro 6D temp for the first half of 2021.

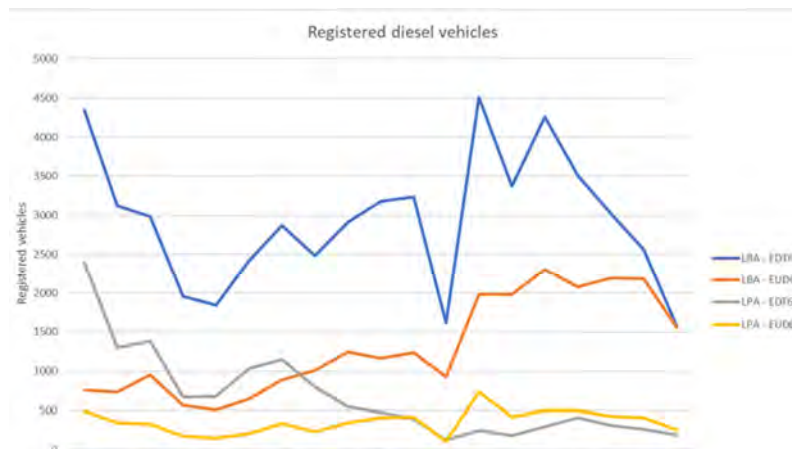

Figure 5.2: Monthly new registrations of diesel Euro 6d and 6d-TEMP light commercial- and passenger vehicles.

6. Conclusions

Emission levels within RDE boundaries in daily use

For every tested vehicle, the average NO_x emission levels per trip during the measurement campaign are well below the RDE NO_x limit. Especially during the driven RDE trips, the average NO_x emissions were very low (< 10 mg/km). Also, during the monitoring phase (trips without specific instructions), the average NO_x emissions over all trips combined are low (<50 mg/km). The highest average NO_x emissions occurred for all diesel vehicles while driving in urban areas. Especially areas with a speed limit of 30 km/h showed higher NO_x emissions. For the Citroën Berlingo the average emissions in these areas were approximately 220 mg/km. The VW Caddy and Peugeot Expert showed substantially lower emissions with respectively 120 and 100 mg/km. During the RDE trips, NO_x emissions in urban areas were substantially lower, for all vehicles below 10 mg/km. The NO_x emissions during rural and motorway driving are consistently low for all three diesel vehicles.

Outstanding problems in current emission legislation

Cold engine start emissions; the remaining emission source, beyond 2030

The NO_x emissions associated with a cold engine start are dominant in the NO_x emission performance for the tested Euro 6d diesel vehicles.

The contribution of the cold start NO_x emissions to the total trip emissions is considerably more than 50% for the majority of the trips. This holds true for short trips of 10 kilometers or less, but also for a large part of the longer trips. On average 70% of the total trip NO_x emissions is emitted during the first 1.4 kilometers of the cold start trip. On average 70% of the total trip emissions is emitted during the first 1.4 kilometres. The emissions associated with the cold engine start vary per vehicle, but it is for all vehicles the dominant emissions source. Moreover, the conditions prior to a cold engine start trip have an influence on the magnitude of the cold start emissions.

In addition, a worst-case test was performed, i.e. a wide-open throttle acceleration (0 to 100 km/h) directly after a cold engine start, after this wide-open throttle acceleration the vehicle kept driving on the motorway for approximately 56 kilometers. During the cold start period (between 0.8 and 1.5 km), the vehicles emit up to 93% of the total trip (56 km) NO_x emissions, despite multiple wide-open throttle accelerations on the motorway after the cold start period. Under these starting conditions, the vehicle with the highest emissions needs a trip of approximately 13 kilometers to comply with the emission limit of 179 mg/km. This shows that some modern vehicles already comply with stricter requirements than those currently in force, whereby during the legal RDE cold start, the driving behaviour has to meet many conditions.

The tested petrol vehicle, which was less extensively tested than the diesel vehicles, showed a shorter cold start period with a lower impact on NO_x emissions. On average 37% of the total trip NO_x emissions were emitted during the first 160 meters. Moreover, 76% of the total trip THC emissions were emitted during the first 400 meters.

Since the lifespan of these vehicle is more than 10 years, the cold engine start effect is expected to have a significant contribution to local air pollution beyond 2030.

Prolonged idling in normal use can lead to elevated emissions

Elevated emissions can occur during prolonged idling events with the tested diesel vehicles. NO_x emissions during these events can be up 1.0 mg/s, depending on the vehicle and/or engine strategy. To put the 1.0 mg/s NO_x emission in broader perspective: if a vehicle would drive 25 km/h while it emits NO_x at a rate of 1.0 mg/s, the NO_x emission is 144 mg/km. The RDE trip requirements describe an idling time limit of 300 seconds. For multiple idling events the elevation of NO_x emissions starts after 300 seconds. The tested petrol vehicle did not show high emissions during idling. In normal use of vehicles, long idling events are not uncommon. Taxi's idle while waiting for passengers, vehicles queuing in traffic accidents, and vehicles waiting for open bridges are examples of prolonged idling events that result in additional NO_x emission.

High engine load; not the main issue for NO_x emissions

High engine loads are not the main source of elevated NO_x emissions for the diesel vehicles, as long as the after-treatment system has reached operating temperature. The NO_x emissions are in general not disproportionately increasing at higher engine loads. Nevertheless, the diesel vehicles show in general an increase in NO_x emissions at higher levels of dynamic driving, which also includes higher engine loads. When the engine loads during on-road monitoring are compared to the driven RDE trips, the on-road monitoring data show a much wider coverage of engine loads, with higher emissions as well.

Future legislation, Euro-7

The emission performance of the tested vehicles is very good. This confirms the results which were shown in earlier test programmes with Euro-6d and Euro 6-TEMP diesel vehicles. A major improvement over the previous generations Euro-6 diesel vehicles, which had to satisfy the same emission limits, but not in on-road emission tests. Clearly, the actual details of testing make a large difference in the emission performance. Moreover, the step from Euro-6d-Temp to Euro-6d is a further significant improvement in emissions. If these levels are maintained in the newer generations of diesel vehicles, and over their lifetime, their relevance for air-quality problems is decimated, from the Euro-5, or diesel scandal, levels.

A few of the outstanding issues with Euro-6d diesel NO_x emissions are the coverage of the on-road RDE tests and the lifetime emission with maintenance and tampering issues. Both prolonged idling and hard accelerations are excluded from the RDE test. It is observed that a number of vehicles have much higher emissions in these situations than otherwise in normal use. Vehicles seem optimized for good RDE performance, with limited robustness for other driving situations. Moreover, cold start emissions have a limited contribution in the overall RDE test result that is compared with the limit. In the Advisory Group on Vehicle Emissions Standards these issues were raised, and the current proposal is to reduce the test boundary, and allow any trip to be a valid test for evaluation against the emission legislation. The Commission proposal for Euro-7 legislation is expected early 2021, and likely this recommendation is included, extending the emission testing, and limited further the few cases in which high emissions are accepted.

Online OBD NO_x monitoring

Multiple Light-duty vehicle manufacturers indicate that no online NO_x monitoring is applied on their Euro 6d vehicles.

Respondents added that the discussion of data ownership could be an issue when online NO_x monitoring is applied by the manufacturers themselves. Each vehicle owner must agree on sharing its data with the manufacturer in a scenario where online OBD NO_x monitoring is applied.

In-vehicle NO_x sensor emission monitoring

The Euro 6d diesel vehicles measured in this project all have a NO_x signal available on the on-board diagnostics (OBD) port of the vehicle. However, the suitability of an in-vehicle NO_x sensor signal for emission monitoring purposes strongly depends on its position in the exhaust pipe. It's important to know if the signal is pre-SCR catalyst or post- SCR catalyst and if the sensor represents tailpipe out emissions or if there is another catalyst like the ASC (Ammonia Slip Catalyst) after the NO_x sensor. Pre-catalyst in-vehicle NO_x sensors are not suitable for determining tailpipe-out NO_x emissions. The position of an in-vehicle NO_x sensor in the exhaust pipe can't be determined by its naming when reading it from the OBD port. It is therefore not always clear which OBD NO_x signal corresponds to which NO_x sensor in the exhaust pipe. This study showed that the in-vehicle NO_x sensor signal is different for each test vehicle regarding its naming, position and availability. In this project only one of the three tested diesel vehicles have a tailpipe-out in-vehicle NO_x sensor. The other two vehicles only have pre-SCR and pre-ASC NO_x sensors available on the OBD port.

For all three vehicles, the NO_x signal on the OBD port needs significant start-up times (ranging from 60 to 1500 seconds). The data shows that the start-up duration is not a fixed amount of time. More detailed research is needed for a better understanding if these start-up times are related to specific conditions. This will make it currently impossible to measure NO_x emission during the cold engine start period. The emissions related to the cold engine start period are dominant compared to other circumstances, like high engine loads. Moreover, the in-vehicle NO_x signal often correlates not very well with measurements from independent measurements (with SEMS). There were, however, some trips with only small deviations between the results from the in-vehicle signals and SEMS. A more detailed analysis is needed for a better understanding between these observed differences. More understanding is needed if the differences are related to specific conditions, like exhaust temperature, engine load and driving dynamics.

NO_x monitoring via in-vehicle signals is currently not an accurate method to assess the NO_x emission performance. Nevertheless, under certain conditions it can be an interesting method to gather data on NO_x-performance.

The in-vehicle NO_x sensors have potential for accurate NO_x monitoring purposes when:

- It is clear which OBD NO_x signal corresponds to which NO_x sensor;
- there is a NO_x sensor located post-catalysts / tailpipe-out;
- the NO_x sensor is active at the start of the trip order to include cold start emissions;

- the OBD NO_x signal can be combined with other parameters to determine the exhaust mass flow, like the Mass Air Flow- and O₂ signals (for emission mass-flow calculations),

If a vehicle does not comply with these points, it's not suitable for an accurate NO_x emission monitoring fully based on the in-vehicle signals. However, if the signal and the quality of the in-vehicle NO_x sensor is better understood, the availability of the OBD NO_x signal and location of the sensor only can potentially be useful for other purposes than accurate emission monitoring.

It may be possible to determine elevated emissions in case of:

- Malfunction of the aftertreatment system, due to a defect or manipulation;
- Detection of elevated emissions in specific conditions (e.g. for conditions which are not covered in the emissions legislation);
- Monitoring of possible deterioration of the after-treatment system (the deterioration or malfunctions of the NO_x sensor itself should be considered as well).

7. Abbreviations

OBD	On-Board Diagnostics
EOBD	European OBD
PEMS	Portable Emission Measurement System
ISC-RDE	In-Service-Conformity Real-Driving Emissions
NO _x	Nitrogen oxides and nitrogen dioxides
SCR	Selective Catalytic Reduction
DBC	CAN database
ECU	Electronic control unit
AGVES	Advisory Group on Vehicle Emission Standards
ASC	Ammonia Slip Catalyst
OTA	Over The Air
TWC	Three Way Catalyst
MAF	Mass Air Flow

8. References

1. **Gil, Elena Sala.** *Evaluation of Ammonia Slip Catalysts*. Göteborg : Department of Chemical and Biological Engineering, 2013.
2. **J.S. Speen, G. Kadijk, R.J. Vermeulen, V.A.M. Heijne, N.E. Ligterink, U. Stelwagen, R.T.M. Smokers, P.J. van der Mark, G. Geilenkirchen (PBL).** *TNO 2016 R11178v2*. Delft : TNO, 2016.
3. **Speen, J. S., Kadijk, G., Vermeulen, R. J., Heijne, V. A. M., Ligterink, N. E., Stelwagen, U., ... & Van der Mark, P. J.** *Assessment of road vehicle emissions: methodology of the Dutch in-service testing programmes*. s.l. : TNO, 2016.
4. **European Commission.** European Commission. *European Union Law*. [Online] 27 11 2018. <http://data.europa.eu/eli/reg/2018/1832/2018-11-27>.
5. **Regulation 459/2012 of the European Commission.** [Online]

9. Signature

The Hague, 28 February 2022

TNO

Projectmanager

Author

A SEMS Euro 6d installation schematic

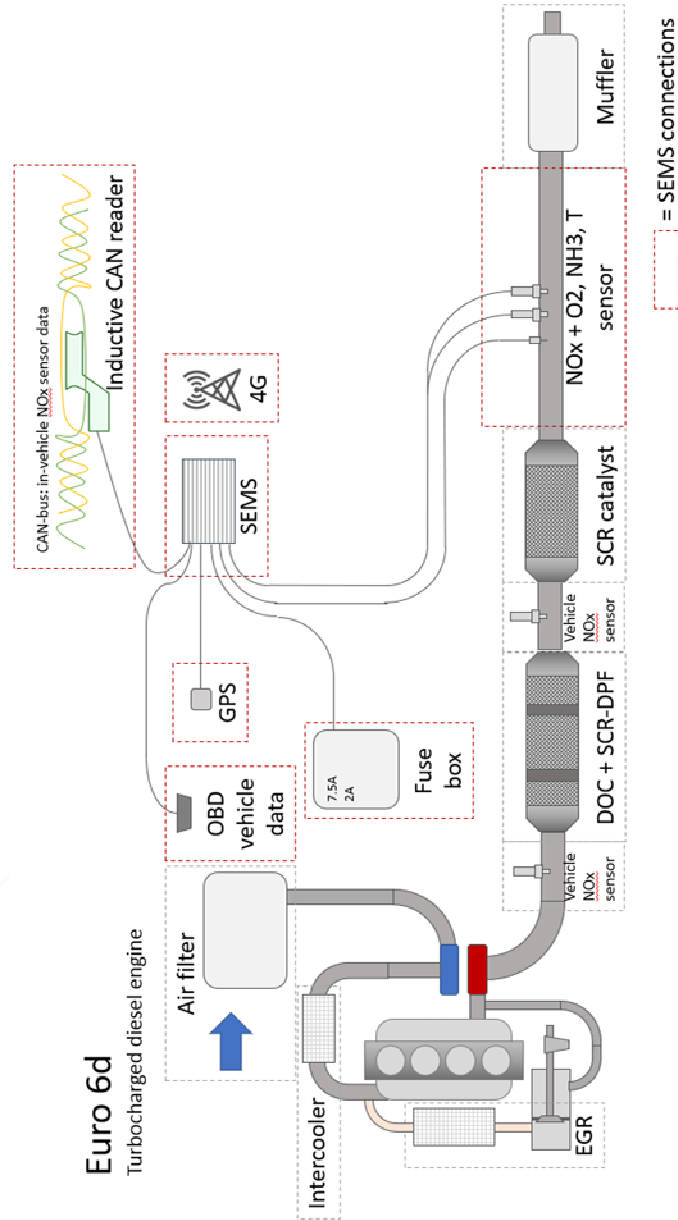

The position of vehicle NOx sensors can be different for each vehicle.

Figure A-1: Schematic overview of the SEMS installation on an Euro 6d diesel vehicle.

B Test program & driving styles

Emission test program

Drivers instructions

The driver followed the driving style instructions as shown in Table B-1 for the trips shown in Table 2-1.

Table B-1: Driving instructions for two driving styles.

Item	Unit	Regular	Sportive
Fuel consumption		<i>regular</i>	<i>high</i>
Rijgedrag		<i>regular</i>	<i>sportive</i>
Start engine		<i>warm</i>	<i>cold</i>
Gear shift engine speed	[rpm]	2500	3500
Brake before stop line	[m]	60	30
From gaspedal to brake	[s]	3	0
Lights		<i>aut.</i>	<i>on</i>
Start-stop active		<i>yes</i>	<i>no</i>
Maximum throttle	[%]	90	100
Gaspedal control		<i>until kick-down</i>	<i>Incl. kick-down</i>
Maximum snelheid snelweg	[km/h]	115-125	125-135

C Engine power: RDE versus on-road monitoring

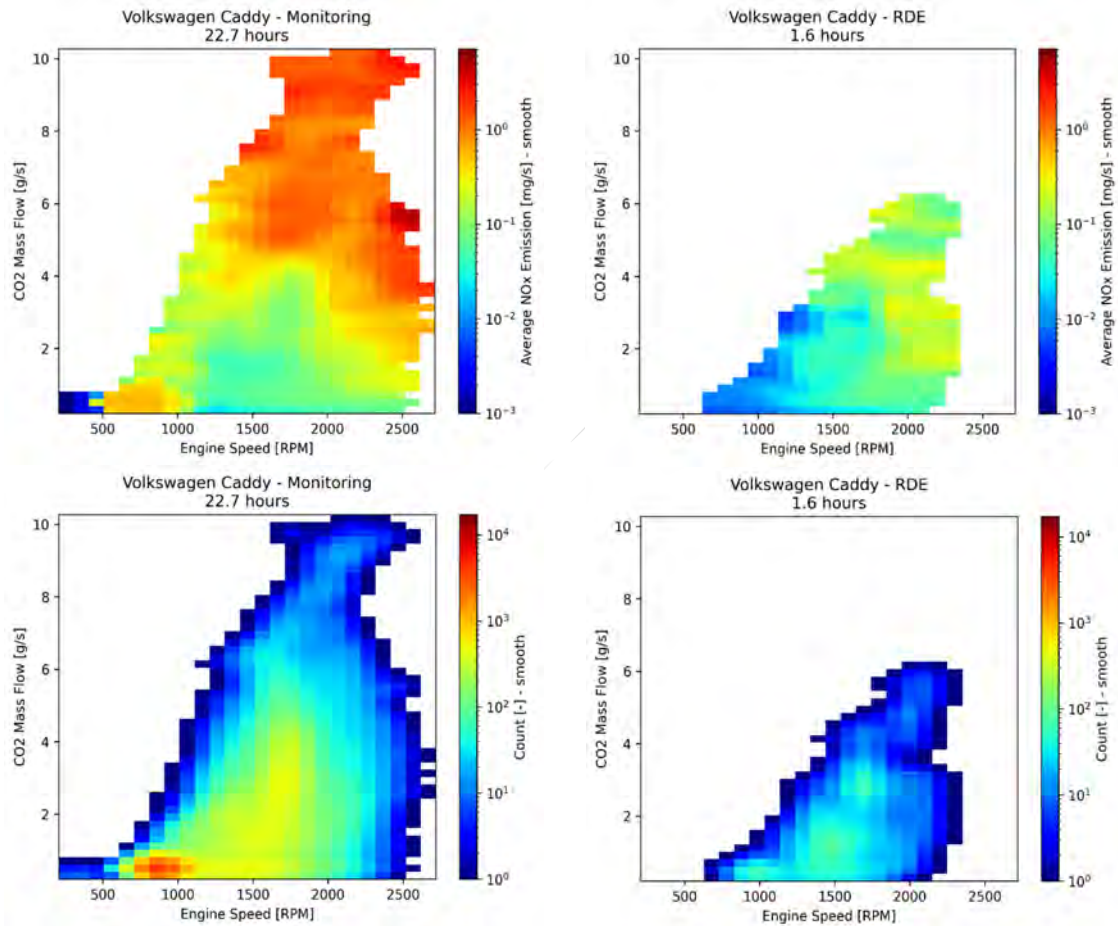

Figure C-1: The upper figures show coverage of engine operation during 22.7 hours of on-road emission monitoring and a RDE trip of the Euro 6d diesel Volkswagen Caddy. The bottom figures show the count of occurrences in certain engine operating points.

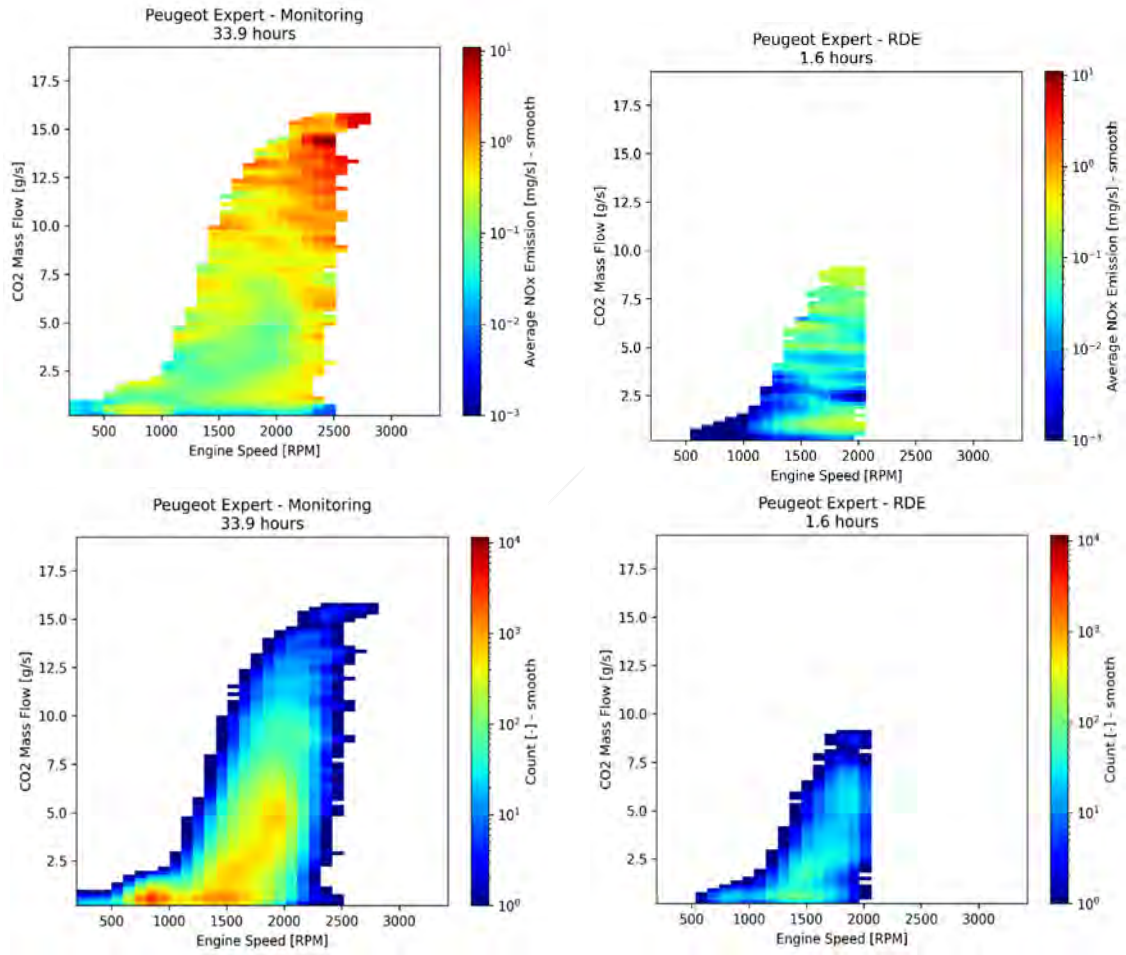

Figure C-2: The upper figures show coverage of engine operation during 33.9 hours of on-road emission monitoring and a RDE trip of the Euro 6d diesel Peugeot Expert. The bottom figures show the count of occurrences in certain engine operating points