



Ministry of Infrastructure and the
Environment

Convention on Nuclear Safety (CNS)

National Report of the Kingdom of the Netherlands
for the Seventh Review Meeting
(March-April 2017)

The Hague, August 2016

This report has been prepared by the Dutch Authority for nuclear safety and radiation protection, ANVS.

CONTENTS

LIST OF SYMBOLS AND ABBREVIATIONS	9
INTRODUCTION	17
SUMMARY	23
PART I REGULAR CNS-TOPICS	23
Changes to legislative and regulatory framework	23
Regulatory body - developments	24
Recent considerations on regulatory and safety issues	25
Results of international peer review missions and implementation of their findings	27
Drills, exercises and lessons learned	28
Actions on transparency and communication with the public	28
Important issues identified in previous report and follow-up	28
PART II POST-FUKUSHIMA DAIICHI MEASURES	30
Participation of the Netherlands in international self assessment exercises	30
Tabulated lists of post-Fukushima Daiichi actions	30
Response on 'Observations and lessons – DG's Report on the Fukushima Daiichi Accident'	30
PART III VIENNA DECLARATION	33
CHAPTER 2(A) GENERAL PROVISIONS	35
ARTICLE 6. EXISTING NUCLEAR INSTALLATIONS	35
6.1.a Existing installations	35
6.1.b Borssele NPP	35
6.1.c Dodewaard NPP	36
6.1.d Research Reactors: High Flux Reactor (HFR)	36
6.1.e Research Reactors: HOR in Delft	36
6.1.f Plans for new Research Reactor: PALLAS	37
6.1.g Project for upgrading of Research Reactor HOR: OYSTER	37
6.2 Overview of safety assessments and other evaluations	37
6.2.a Borssele NPP	37
6.2.b HFR RR	38
6.2.c Challenges from plans for new-build, upgrading and other activities of LHs	39
CHAPTER 2(B) LEGISLATION AND REGULATION	41
ARTICLE 7. LEGISLATIVE AND REGULATORY FRAMEWORK	41
7.1 Legislative and regulatory framework	41
7.1.a Overview of the legal framework	41
7.1.b Primary legislative framework: laws	43
Nuclear Energy Act	44
Environmental Protection Act (Wm)	46
General Administrative Act (Awb)	46
Act on the liability for nuclear accidents ('Wet Aansprakelijkheid Kernongevallen', WAKO)	47
Water Act ('Waterwet', Ww)	47
Environmental Permitting (General Provisions) Act (Wabo)	47
Dutch Safety Region Act ('Wet veiligheidsregio's', Wvr)	48
Act on Government Information ('Wet Openbaarheid van Bestuur', WOB)	48
7.1.c Ratification of international conventions and legal instruments related to nuclear safety	48
7.1.d Special agreements	50
7.2 Provisions in the legislative and regulatory framework	51

7.2. (i) National safety requirements and regulations.....	51
Governmental Decrees ('Besluiten')	51
Ministerial Decrees or Ordinances ('Ministeriële Regelingen, MR');	55
Adopted foreign nuclear codes and standards	57
Adopted industrial standards	57
7.2. (ii) System of licensing.....	58
7.2. (iii) Regulatory assessment and inspections	59
7.2. (iv) Enforcement	61
ARTICLE 8. REGULATORY BODY	63
8.1.a General	63
8.1.b Entities of the RB	64
8.1.c Regulatory Body – tasks	65
8.1.d Organisation of the ANVS.....	65
8.1.e Coordination of activities for managing nuclear accidents and incidents	67
8.1.f Development and maintenance of Human Resources at the ANVS	67
8.1.g Financial resources.....	69
8.1.h Quality management system of the RB	69
8.1.i Openess and transparency of regulatory activities.....	69
8.1.j Publication of (summaries) of inspection reports.Future and current challenges for the Regulatory Body.....	70
8.1.k External Technical Support.....	71
8.1.l Advisory Committees	72
8.2 Status of the Regulatory Body	73
8.2.a Governmental structure	73
8.2.b Future development of the Regulatory Body	73
8.2.c Reporting obligations	73
8.2.d Separation of protection and promotion	74
ARTICLE 9. RESPONSIBILITY OF THE LICENCE HOLDER	75
CHAPTER 2(C) GENERAL SAFETY CONSIDERATIONS	79
ARTICLE 10. PRIORITY TO SAFETY	79
10.1 Policy on nuclear safety	79
10.1.a Regulatory requirements and implementation	79
10.1.b Licence Holder's (EPZ's) policy and organisation	79
10.1.c Supervision of priority to safety.....	80
10.2 Safety culture.....	81
10.2.a Requirements	81
10.2.b Safety culture at Borssele NPP.....	81
10.2.c Supervision of safety culture.....	82
10.3 Management of safety (including monitoring and self-assessment)	82
10.3.a Requirements	82
10.3.b Self-assessment by LH (EPZ of Borssele NPP)	82
10.3.c Supervision of safety management (including monitoring and self- assessment).....	83
10.4 Safety culture at the Regulatory Body	83
ARTICLE 11. FINANCIAL AND HUMAN RESOURCES	85
11.1 Adequate financial resources	85
11.1.a Economic background	85
11.1.b Legislative aspects of responsibility and ownership.....	86
11.1.c Rules and regulations on adequate financial resources for safe operation ..	86
11.1.d Financing of safety improvements at Borssele NPP	87
11.1.e Rules and regulations on financial resources for waste management activities	87

11.1.f	Rules and regulations on financing decommissioning	89
11.1.g	Statement regarding the adequacy of financial provision	89
11.1.h	Supervision of financial arrangements and provisions	90
11.2	Human resources.....	90
11.2.a	Legislative aspects	90
11.2.b	Training and qualification of EPZ staff	91
11.2.c	Assessment method of sufficiency of staff.....	93
11.2.d	National supply of and demand for experts in nuclear science and technology	93
11.2.e	Supervision of human resources.....	93
ARTICLE 12. HUMAN FACTORS		95
12.1	Introduction	95
12.2	Legislative aspects of HF.....	95
12.3	Methods and programmes for human error	95
12.4	Self-assessment of managerial and organizational issues	96
12.5	Human factors and organisational issues in incident analysis.....	96
12.6	Human factors in organisational changes	97
12.7	Fitness for duty	97
12.8	Supervision	97
ARTICLE 13. QUALITY ASSURANCE.....		99
13.1	Introduction	99
13.2	Regulations.....	99
13.3	The integrated management system (IMS) at the Licence Holder	99
13.4	Supervision of the management system by the Regulatory Body.....	100
ARTICLE 14. ASSESSMENT AND VERIFICATION OF SAFETY		101
14.(i)	Assessment of safety.....	101
14.(ii)	Verification by analysis, surveillance, testing and inspection	106
ARTICLE 15. RADIATION PROTECTION		109
15.1	Radiation protection for workers	109
15.2	Radiation protection for the public.....	111
ARTICLE 16. EMERGENCY PREPAREDNESS.....		113
16.1	Emergency plans	113
16.1.a	On-site: SAM	113
	Regulatory framework	113
	SAM strategy at the LH.....	114
	Communication of the LH with the RB in emergency situations	115
	SAM facilities at the LH	115
	Training of the emergency organisation of the LH	116
16.1.b	Off-site: EP&R and PAM	116
	Regulatory framework	117
	National Organisations for EP&R and PAM	117
	Local organisations for EP&R and PAM	118
	Intervention levels and measures	119
	NCS response plan, training exercises and their organisation	121
16.2	Providing information to the public and neighbouring states	122
16.2.a	Arrangements to inform the public about emergency planning and emergency situations.....	122
16.2.b	Arrangement for informing competent authorities in neighbouring countries 123	
CHAPTER 2(D) SAFETY OF INSTALLATIONS		125
ARTICLE 17. SITING		125
17.(i)	Evaluation of site-related factors.....	125

CONTENTS

17.(ii) Impact of installation on individuals, society and environment	127
17.(iii) Re-evaluating of relevant factors	127
17.(iv) Consultation with other contracting parties	128
ARTICLE 18. DESIGN AND CONSTRUCTION	129
18.(i) Implementation of Defence in Depth	129
18.(ii) Technology incorporated proven by experience of qualified by testing or analysis	135
18.(iii) Design in relation to human factors and man-machine interface	137
ARTICLE 19. OPERATION	139
19.(i) Initial authorisation to operate: safety analysis and commissioning programme	139
19.(ii) Operational limits and conditions.....	140
19.(iii) Procedures for operation, maintenance, inspection and testing.....	141
19.(iv) Procedures for response to anticipated operational occurrences and accidents	143
19.(v) Engineering and technical support	143
19.(vi) Reporting of incidents	144
19.(vii) Sharing of important experience	145
19.(viii) Generation and storage of radioactive waste	146
Appendix 1 SAFETY POLICY AND SAFETY OBJECTIVES IN THE NETHERLANDS.....	147
a. Safety objectives in a historic perspective	147
a.1. Technical safety objective.....	147
a.2. Radiological safety objective	147
b. Dutch environmental risk policy	148
c. Continuous improvement.....	150
d. Regulatory developments.....	150
Appendix 2 THE ROLE OF PSAs IN ASSESSING SAFETY	157
a. History of the role of PSAs and their role in the Netherlands	157
b. Guidance for and review of the PSAs	157
c. Living PSA applications.....	158
d. Transition towards a more Risk-informed Regulation	160
Appendix 3 THE SAFETY CULTURE AT BORSSELE NPP	161
a. Introduction	161
b. Introduction of safety culture programme	161
c. Evaluation of safety culture programme	162
Appendix 4 REQUIREMENTS AND SAFETY GUIDES FOR THE BORSSELE NPP LICENCE	165
Appendix 5 TECHNICAL DETAILS OF BORSSELE NPP	171
a. Technical specifications.....	171
b. Safety improvements from the first 10-yearly Periodic Safety Review	173
c. Modifications due to the second 10-yearly Periodic Safety Review	173
d. Third PSR.....	174
e. Data on radiation protection and exposure	175
g. Discharges, doses and other relevant diagrams for Borssele NPP	177
Appendix 6 BORSSELE NPP COVENANT	183
Introduction Covenant.....	183
Borssele Benchmark Committee	183
Appendix 7 HIGH FLUX REACTOR (HFR)	185
a. General description	185
b. History and use of HFR	185
c. Modifications.....	186
d. Licence renewal	187
e. IAEA-INSARR missions.....	187

f. Tritium leakage to the environment	188
g. Primary system leakage and repair	188
Appendix 8 Missions to Nuclear Installations and the RB.....	191
a. SALTO 2014 Follow-up on SALTO 2012 (including some open issues from SALTO 2009).....	191
b. OSART 2014 mission findings	191
c. IRRS 2014 mission findings	193
Appendix 9 Post-Fukushima Daiichi measures	195
Appendix 10 Response on Observations and Lessons in DG’s Report on the Fukushima Daiichi Accident.....	205

FIGURES

Figure 1 Simplified representation of the hierarchy of the legal framework	41
Figure 2 Organisation of the ANVS	66
Figure 3 The anticipated position of the DSR in the regulatory framework will be at the level of the NVRs.....	152
Figure 4 Cross-section of reactor building of Borssele NPP.....	172
Figure 5 Borssele NPP discharges in air of I-131. Licence limit is 5000 Mq/year.	177
Figure 6 Borssele NPP discharges in air of noble gases. Licence limit is 500 TBq/year.	177
Figure 7 Borssele NPP discharges in air of tritium, licence limit 2 TBq/year.....	178
Figure 8 Borssele NPP discharges in water of beta/gamma emitters. Licence limit 200 Gbq/year.....	178
Figure 9 Borssele NPP discharges in water of tritium, licence limit 30 TBq/year.....	179
Figure 10 Borssele NPP annual collective occupational dose	179
Figure 11 Number of incident reports	180
Figure 12 Unplanned automatic scrams.	180
Figure 13 Unit capability factor.....	181
Figure 14 3D Cross section of reactor building of the HFR	189
Figure 15 Reactor vessel in reactor pool of the HFR	190

TABLES

Table 1 Measures and intervention levels.....	119
Table 2 Intervention levels in mSv: default value, range and international comparison	120
Table 3 Planning zones.....	120
Table 4 Technical safety concept in DSR, based on WENRA guidance	154
Table 5 National post-stress test Actions – initiated by (or imposed by RB) on LH (operator of one NPP unit) – Status April 2016.....	195
Table 6 National post-stress test Actions – acting on and initiated by the national RB	202
Table 7 Response of the Netherlands on ‘Observations and lessons – DG’s Report on the Fukushima Daiichi Accident’	205

LIST OF SYMBOLS AND ABBREVIATIONS

Abbreviation	Full term	Translation or explanation (in brackets)
ALARA	As Low As Reasonably Achievable	
ANS	American Nuclear Society	
ANSI	American National Standards Institute	
AOT	Allowed Outage Times	
ASME	American Society of Mechanical Engineers	
ATWS	Anticipated Transient Without Scram	
Bkse	Besluit kerninstallaties, splijtstoffen en ertsen	Nuclear installations, fissionable materials, and ores Decree
BV	Besloten Vennootschap	Private company with limited liability
BWR	Boiling Water Reactor	
Bvser	Besluit vervoer splijtstoffen, ertsen en radioactieve stoffen	Transport of fissionable materials, ores, and radioactive substances Decree
BZK	(Ministerie van) Binnenlandse Zaken en Koninkrijksrelaties	(Ministry of) the Interior and Kingdom Relations
COSYMA	Code SYstem from MAria (MAria = Methods for Assessing the radiological impact of accidents)	(Computer code for radiological consequence analysis)
COVRA	Centrale Organisatie voor Radioactief Afval	Dutch central organisation for [interim storage of] nuclear waste
CSF	Critical Safety Functions	
CSNI	Committee on the Safety of Nuclear Installations	(OECD/NEA)
ECCS	Emergency Core Cooling System	

LIST OF SYMBOLS AND ABBREVIATIONS

Abbreviation	Full term	Translation or explanation (in brackets)
ECN	Energieonderzoek Centrum Nederland	Netherlands Energy Research Foundation
EIA	Environmental Impact Assessment	
ENSREG	European Nuclear Safety Regulators Group	European group of regulators
EOP	Emergency Operating Procedure	
EPZ	NV Elektriciteits- Productiemaatschappij Zuid- Nederland	License holder, owner and operator of Borssele NPP
ESFAS	Engineered Safety Features Activation System	
ETC	Enrichment Technology Group Ltd	Subsidiary of Urenco and Areva, focussing on enrichment technology
ET-NL	Enrichment Technology Nederland B.V.	Subsidiary of ETC Ltd
EU	European Union	
EZ	(Ministerie van) Economische Zaken	(Ministry of) Economic Affairs
€	EURO	
FANC	Federaal Agentschap voor Nucleaire Controle	The Belgian regulatory Body, Belgian federal agency for nuclear control
GE	General Electric	
FRG	Function Recovery Guideline	
GBq	GigaBecquerel	(Giga = 10 ⁹)
GKN	Gemeenschappelijke Kernenergiecentrale Nederland	License holder owner and operator of Dodewaard NPP, (in Safe Enclosure)
GRS	Gesellschaft für Anlagen- und Reaktorsicherheit	(Global Research for Safety, Nuclear safety experts organisation, Germany)

Abbreviation	Full term	Translation or explanation (in brackets)
H _{eff}	Effective dose equivalent	
HEU	High Enriched Uranium	
HFR	High Flux Reactor	Research reactor (in Petten, tank-in-pool type, 45 MW _{th})
HOR	Hoger Onderwijs Reactor	Research reactor (Delft University of Technology)
HP&SC	Human Performance & Safety Culture	
HPES	Human Performance Enhancement System	
I&C	Instrumentation and Control	
IAEA	International Atomic Energy Agency	
IEEE	Institute of Electrical and Electronic Engineers	
I&M	(Ministerie van) Infrastructuur en Milieu	(Ministry of) Infrastructure and the Environment
ILT	'Inspectie Leefomgeving en Transport'	Human Environment and Transport Inspectorate of the ministry of Infrastructure & the Environment
INSAG	International Nuclear Safety Advisory Group	(IAEA)
IPERS	International Peer Review Service	(IAEA)
IPSART	International PSA Review Team	Current name of IPERS (IAEA)
IRS	Incident Response System	
ISCA	Independent Safety Culture Assessment	
ISO	International Standards Organisation	

LIST OF SYMBOLS AND ABBREVIATIONS

Abbreviation	Full term	Translation or explanation (in brackets)
JRC	Joint Research Centre of the European Communities	
KEMA	NV tot Keuring van Elektrotechnische Materialen	(Dutch utilities research institute)
Kew	Kernenergiewet	Nuclear energy act
KTA	Kerntechnischer Ausschuss	Nuclear Standards Technical Committee (Germany)
KWU	Kraftwerk Union	(Siemens nuclear power group, nowadays Framatome ANP)
LEU	Low Enriched Uranium	
LH	Licence Holder, licensee	
LOCA	Loss of coolant accident	
LPSA	Living PSA	
LTO	Long Term Operation	
MBq	MegaBecquerel	(Mega = 10^6)
MER	Milieu-effect rapport	Environmental Impact Assessment (EIA)
mSv	milliSievert	(Milli = 10^{-3})
μ Sv	microSievert	(Micro = 10^{-6})
MMI	Man Machine Interface	
MW _e	Megawatt electrical	
MW _{th}	Megawatt thermal	
NACp	National Action Plan	National plan of the implementation of post-stress test measures
NDRIS	National Dose Registration and Information System	
NERS	NETwork of Regulators of countries with Small nuclear programs	

Abbreviation	Full term	Translation or explanation (in brackets)
NEA	Nuclear Energy Agency	(An OECD agency)
NPK	Nationaal Plan Kernongevallen- bestrijding	National Nuclear Emergency Plan (The Netherlands)
NPP	Nuclear Power Plant	
NRG	Nuclear Research and consultancy Group	(subsidiary of ECN, license holder and operator of the HFR)
NRWG	Nuclear Regulators Working Group	(EU)
NUSS	Nuclear Safety Standards	(of the IAEA, old series)
NUSSC	Nuclear Safety Standards Committee	(IAEA)
NVR	Nucleaire Veiligheids Regels	Nuclear safety rules (in the Netherlands)
OECD	Organisation for Economic Cooperation and Development	
OLC	Operational Limits and Conditions	
OSART	Operational Safety Review Team	(IAEA)
P&Id	Process and Instrumentation diagram	
PIE	Postulated Initiating Event	
PORV	Power-Operated Relief Valve	
POS	Plant Operational State	
PRA	Probabilistic Risk Assessment	
PSA	Probabilistic Safety Assessment	
PSI	Proliferation Security Initiative	Initiative under UNSCR 1540
PSR	Periodic Safety Review	
PWR	Pressurised-Water Reactor	
QA	Quality Assurance	
RB	Regulatory Body	

LIST OF SYMBOLS AND ABBREVIATIONS

Abbreviation	Full term	Translation or explanation (in brackets)
RHR	Residual Heat Removal	
RID	Reactor Institute Delft	(Operator of the HOR research reactor in Delft)
RIVM	Rijksinstituut voor Volksgezondheid en Milieu	National Institute for Public Health and the Environment (The Netherlands)
RPS	Reactor Protection System	
RPV	Reactor Pressure Vessel	
RSK	Reaktor Sicherheits Kommission	Reactor Safety Committee (Germany)
SAMG	Severe Accident Management Guidelines	
SAR	Safety Analysis Report	
SG	Steam Generator	
SGTR	Steam Generator Tube Rupture	
SR	Safety Report	Presents a summary of the most relevant information of the SAR.
SSCs	Structures, Systems and Components	
Sv	Sievert	
SZW	(Ministerie van) Sociale Zaken en Werkgelegenheid	(Ministry of) Social Affairs and Employment
TBq	TeraBecquerel	(Tera = 10^{12})
TCDF	Total Core Damage Frequency	
TIP	Technical Information Package	at Borssele NPP also known as SAR
TMI	Three Mile Island	
TÜV	Technischer Überwachungs Verein	(Safety inspectorate, Germany)
URENCO	URanium ENrichment CORporation Ltd	

Abbreviation	Full term	Translation or explanation (in brackets)
USNRC	United States Nuclear Regulatory Commission	
VGB	Verein Grosskraftwerk Betreiber	(Power plant owners group, Germany)
VROM	Volkshuisvesting, Ruimtelijke Ordening en Milieubeheer	Former (Ministry of) Housing, Spatial Planning, and the Environment
WANO	World Association of Nuclear Operators	
VWS	(Ministerie van) Volksgezondheid, Welzijn en Sport	(Ministry of) Health, Welfare, and Sport
WENRA	Western European Nuclear Regulators Association	
Wm	Wet milieubeheer	Environmental protection act

INTRODUCTION

This section sets out the purpose of the present report, and it continues with an overview of the national nuclear programme followed by a description of the national policy towards nuclear activities in the Netherlands and the main safety issues of the reporting period. The introduction finishes with a description of the structure of the report.

Purpose of the report

On 20 September 1994, the Kingdom of the Netherlands signed the Convention on Nuclear Safety (CNS). It was subsequently formally ratified on 15 October 1996 and entered into force on 13 January 1997. The Convention obliges each Contracting Party to apply widely recognised principles and tools in order to maintain a high level of safety at its nuclear power plants. It also requires each Contracting Party to report on the national implementation of these principles to meetings of the parties to the Convention.

This present report has been prepared by the Kingdom of the Netherlands for the Seventh Review Meeting of the Contracting Parties to the Convention on Nuclear Safety. It shows how the Netherlands meets the obligations of each of the articles of the Convention. Regular Review Meetings of Contracting Parties offer an important opportunity to share information related to implementation of the Convention, and as such the Netherlands has and will continue to actively participate. The Netherlands attaches great importance to the Convention, as well as to the Vienna Declaration on nuclear Safety that was unanimously adopted by Contracting Parties in 2015, as essential to international efforts to strengthen nuclear safety. As this report demonstrates, the Netherlands has developed, and continues to improve a robust domestic framework for nuclear safety in line with its international obligations.

The information provided by the present report applies to the situation of July 1st 2016 unless explicitly specified otherwise. Updates to the information presented in this report may be provided at the CNS peer review meeting in April 2017.

Regulatory Body

In this report the current situation in relation to the RB is used as a reference, which means: the RB is almost entirely constituted by the the Authority for Nuclear Safety and Radiation Protection (ANVS¹) as directorate within the ministry of Infrastructure and the Environment, operating under mandate of the Minister. Expected future developments are described in the Summary and in the text on Article 7, as far as it concerns developments in associated enabling regulation.

The tasks related to nuclear safety which is the subject of this report are within the scope of the ANVS only. Therefore this report often will refer to the ANVS as the RB.

Nuclear programme

The Netherlands has a small nuclear programme, with only one nuclear power plant, producing about 4% of the country's electrical power consumption. The programme features a number of steps of the nuclear fuel cycle. Some of the Dutch nuclear businesses have a global impact. Urenco, at the end of 2015, supplied about 30% of world-demand for low-enriched uranium. Its plant in Almelo, the Netherlands, represents more than a quarter of its production capacity. The company ET-NL in Almelo supplies all centrifuges for the enrichment plants of Urenco and Areva – world-wide. The High Flux Reactor (HFR) in Petten, on average supplies 70% of the European demand for radio-

¹ Dutch: Autoriteit voor Nucleaire Veiligheid en Stralingsbescherming, ANVS

isotopes – and no less than 30% of the global demand. The Nuclear Research & consultancy Group (NRG) operates the HFR and several nuclear research facilities and in addition provides consultancy services to clients on several continents. In addition, scientists of the Dutch universities and NRG participate in many national and international nuclear research programmes.

According to Article 3 of the Convention, the Convention shall apply to the safety of 'nuclear installations'. Article 2 of the Convention defines 'nuclear installations' as civil land-based nuclear power plants and facilities located on the same site as the NPP and related to its operation. This introduction provides an overview of the facilities in the Netherlands that are subject to the Convention and those that are not.

Nuclear facilities subject to the Convention:

- In the South-West of the country, in Borssele, is located the Netherlands' single operating nuclear power plant (NPP). The technical details of the Borssele NPP are provided in Appendix 5 and the NPP is also addressed in the section on Article 6.
- In the East, in Dodewaard near Arnhem, is located a small NPP (60 MW_e). This installation is now in decommissioning, the plant is in so-called 'Safe enclosure'.

Nuclear Facilities not subject to the Convention:

- There are two research reactors in operation. One is located on the premises of the Delft University of Technology (Hoger Onderwijs Reactor, HOR, 2 MW_{th}) and one located on the Research Location Petten (High Flux Reactor, HFR, 45 MW_{th}).
- Additional nuclear research facilities and laboratories can be found at the Delft University of Technology and in Petten (Nuclear Research & consultancy Group, NRG and the EU Joint Research Centre, the JRC);
- In the Eastern part of the country, in Almelo, there are facilities related to uranium enrichment of Urenco Netherlands (uranium enrichment) and Enrichment Technology Netherlands (ET-NL, development and production of centrifuge technology). The licensed capacity currently is 6200 tSW/a.
- In the South-West of the country, in the municipality of Borsele², the COVRA³ interim radioactive waste storage facility is located. COVRA has facilities for the storage of conditioned low, intermediate and high level waste. The latter category includes spent fuel of research reactors and waste from reprocessing of spent fuel of NPPs. More information on COVRA can be found in the Netherlands' various editions of the national report for the Joint Convention⁴ on the Safe Management of Radioactive Waste and Safe Management of Spent Fuel.

Short history of the nuclear programme

The nuclear programme started with the construction of a research reactor in 1955, the High Flux Reactor in Petten, which achieved first criticality in 1961. It was originally thought that nuclear power would play an important role in the country's electricity generation programme. A small prototype reactor (Dodewaard NPP, 60 MW_e) was put into operation in 1968, and in 1973 this was followed by the first commercial reactor (Borssele NPP, 450 MW_e).

Although plans were made to expand nuclear power by 3000 MW_e, these were shelved following the accident at Chernobyl in 1986. Instead, the government ordered a thorough

² Borsele (with one 's') is the name of the municipality in which the village of Borssele (with a double 's') is located.

³ COVRA: Centrale Organisatie Voor Radioactief Afval, Dutch central organisation for interim storage of nuclear waste and spent fuel of research reactors.

⁴ Can be downloaded from ANVS site at <https://www.autoriteitnvs.nl/onderwerpen/joint-convention-reports/documenten/rapport/2015/5/11/joint-convention-report-nl-2015>

screening of the safety of both plants. This led to major back-fitting projects at both of them to improve nuclear safety. The back-fitting project at Borssele was successfully completed in 1997. Meanwhile, mainly because of the negative expectations for the future of nuclear energy in the Netherlands, the small Dodewaard NPP was permanently shut down in 1997. In 2005 the owner of this NPP was granted a licence for a safe enclosure state for a period of 40 years, after which final dismantling shall commence.

In 2006 The Dutch government signed an agreement (the Covenant) with the owners of the Borssele NPP, which allows for operation until the end of 2033, at the latest. In the meantime the Covenant conditions should be met, in addition to the requirements of the Nuclear Energy Act and the licence. The aforementioned end-date of operation is also a requirement in article 15 (section a) of the Nuclear Energy Law. Refer to Appendix 6 for further information on the Covenant.

In 2009 plans were revealed by company Delta N.V.⁵ and Essent/RWE for nuclear new build at the site of the Borssele NPP. Early 2012 both plans were shelved, considering the economic environment and the uncertainties it introduced. Currently these plans are considered to be shelved indefinitely.

A new research reactor (named PALLAS) is under consideration in order to replace the HFR. The national government and the province of North Holland together provided a loan of about 80 Meuro to finalize licensing and design of PALLAS. An important precondition for support is the realisation of a sound business plan and the acquisition of (private) funding for the construction and operation of PALLAS. Currently the project is in a pre-licensing phase where discussions with ANVS are under way about the contents of the license application. The plan is to have the new reactor in operation around 2025.

The Delft University of Technology has launched a project to upgrade its research reactor (project Oyster). The project is jointly financed by the university and the national government.

The operation of the Borssele NPP and the plans for PALLAS and Oyster pose challenges for the ANVS in terms of workload, required expertise and financial constraints. More about these issues can be found in the text on Article 8 'Regulatory Body'.

National policy

Policy on new nuclear power

Guaranteeing nuclear safety has the highest priority in the policy on nuclear power. The Minister of Economic Affairs⁶ in February 2011 sent a letter to Parliament on several aspects of nuclear energy, among which are the preconditions for nuclear new build in the Netherlands. These preconditions present high-level requirements. Within the preconditions, it is up to commercial parties to invest in new nuclear power; in the liberalised energy market the government will not invest in power plants. The more technical preconditions address among others safety, waste management, decommissioning, mining, non-proliferation, and security.

Current policy also includes the requirement to take into account lessons learned from the Fukushima Daiichi accident, as well as the outcomes of the European 'stress test' for nuclear power plants.

⁵ Delta is the majority shareholder of the current NPP but also generates power using biomass, natural gas and wind. In 2015, it took its coal fired plant out of operation permanently.

⁶ At that time, the ministry had a different name: ministry of Economic Affairs, Agriculture and Innovation.

October 2015 the ANVS published the VOBK⁷, the Guidelines on the Safe Design and Operation of Nuclear Reactors - Safety Guidelines for short. These Guidelines provide new reactor licence applicants with detailed insight into what the ANVS considers to be the best available technology.

Policy on research reactors

October 2009, a statement from government backed the idea of the construction of a new research reactor, the PALLAS, to replace the High Flux Reactor (HFR) in Petten. A letter in support was sent from the cabinet to parliament. In this letter, three ministers covering science, technology, planning, education, the environment and the economy supported the construction of PALLAS. In 2011 the government confirmed its support for maintaining the present strong position of the HFR in the production of medical radio isotopes. In 2012, the national and local government have taken several steps to facilitate the organisation of a dedicated PALLAS organisation and the acquisition of private funding. The financing of the upgrade of the research reactor of the Delft University of Technology has also been arranged with the support of the government. For both existing research reactors the regulatory activities of the ANVS are focussed on increasing robustness (through PSR and stress test) and a comprehensive ageing management programme - amongst others through the tailored application of the SALTO approach as developed for NPPs.

Policy on the safe management of spent fuel and nuclear waste

Spent fuel management and waste management are not the subject of the Convention on Nuclear Safety, therefore this topic is addressed only briefly in the present report. For more details, refer to the National Report for the 'Joint Convention on the Safety of Spent Fuel Management and on the Safety of Radioactive Waste Management'⁸, the National Report for the Council Directive 2011/70/EURATOM⁹ and the National Programme for the management of spent fuel and radioactive waste.

Since the nuclear programme of the Netherlands is relatively small, both the total quantities of spent fuel and radioactive waste which have to be managed and the amount of high-level and long-lived waste is modest. Radioactive waste management activities are therefore centralized in one waste management agency, COVRA, operating its facilities at one site. In this way as much benefit as possible is taken from the economy of scale. COVRA is the only authorized organisation for managing radioactive waste and it manages radioactive waste from nuclear and non-nuclear origin.

The policy in the Netherlands is that all radioactive waste must be isolated, controlled and monitored. In principle this can be done by storage in buildings and institutional control. It can also be done by deep geologic disposal, in which case institutional control is likely to be discontinued at some moment. The current policy assumes that the radioactive waste will be stored in buildings (at COVRA) for a period of at least 100 years. During this period the deep geological disposal is prepared financially, technically and socially in such a way that it can be implemented after the storage period. In the current policy it is assumed the disposal facility will be ready to receive radioactive wastes around 2130. The definitive decision on disposal will not be made until around 2100. At that moment in time, society may also opt for another management option, depending on insights at that moment, and assuming that other alternatives are possible

⁷ Dutch: Veilig Ontwerp en het veilig Bedrijven van Kernreactoren, VOBK

⁸ Published by the Netherlands in September 2014 for the Fourth Review Conference in May 2015.

⁹ Council Directive 2011/70/EURATOM establishing a Community framework for the responsible and safe management of spent fuel and radioactive waste

at that time. More details on the policy can be found in the 'National Programme' mentioned before.

Part of the policy is also to have a research programme on geological disposal. The programme addresses among others issues like institutional control and prolonged retrievability of the waste from the repository. The current research programme is named OPERA¹⁰.

The government policy on spent fuel management is that the decision on whether or not to reprocess spent fuel is in the first place a choice for the operator of a NPP. In the early days the operators have decided in favour of reprocessing their spent fuel for economic reasons, reuse of plutonium and reduction of the waste volume.

Main safety issues: Post-Fukushima Daiichi developments

Following the events at the Fukushima Daiichi nuclear power plant in March 2011, the international communities have launched several interrelated initiatives to learn from these events and to initiate dedicated programmes to further enhance nuclear safety. For the Netherlands, the most important ones are 1) the "stress test" led by the European Nuclear Safety Regulatory Group, ENSREG¹¹, 2) actions undertaken by the IAEA under the umbrella of the Convention on Nuclear Safety (CNS), and 3) actions associated with the Vienna Declaration on Nuclear Safety (VDNS).

All post-Fukushima Daiichi measures identified in the Netherlands are recorded in the Dutch National Action Plan (NACp¹²) which was subject to European peer review in 2013 and in 2015. The NACp incorporates findings from the national assessment, the review under the umbrella of ENSREG and the review under the umbrella of the CNS¹³. The measures require actions at the License Holder (LH), but also some at the ANVS. However, various measures listed in the NACp originate from the previously conducted regular Periodic Safety Reviews (PSRs) of the LH and not from the so-called 'stress test'. The NACp will be updated regularly until 2020, when the actions shall be completed. In the Netherlands completion is planned for 2017.

A condensed survey of the related measures planned or being executed in the Netherlands, can be found in the Summary of the present report.

It should be noted that the safety of *all* other nuclear facilities in the Netherlands (and not only the Borssele NPP) has been evaluated in 'stress tests'.

Structure of the report

This updated report follows the format of the previous national report for the Convention on Nuclear Safety, submitted in 2014. The present report complies with the guidelines

¹⁰ Dutch: 'Onderzoeksprogramma Eindberging Radioactief Afval', i.e. research programme on the final disposal of radioactive wastes.

¹¹ Stress test', more precisely formulated as 'Complementary Safety margin Assessment' (CSA).

¹² Netherlands' NACp, National Action Plan (NACp) for the follow-up of post-Fukushima Daiichi related activities, Report for the ENSREG-led NACp Peer Review Workshop to be held in April 2013.

¹³ Findings from the 2nd Convention on Nuclear Safety (CNS) Extraordinary Meeting in August 2012 and CNS-6. Also refer to 'The Netherlands' National Report For the 2nd Convention on Nuclear Safety (CNS) Extraordinary Meeting to be held in August 2012', published in May 2012

presented in the update of INFCIRC/572/Rev.5¹⁴. In drafting the report, notice is also taken of guidance provided in: the five challenges identified by the Special Rapporteur of the 6th CNS (see summary Part II), the Vienna Declaration on Nuclear Safety¹⁵ (VDNS), notes of the Informal Meeting of Nuclear Regulators on following up the VDNS¹⁶ (see Summary Part III), the template provided by the group of experts to support reporting on Article 17 and Article 18 of the CNS¹⁷, and the letter by the president of CNS⁷.

The present report is designed to be a 'stand alone' document to facilitate peer review. However some information¹⁸ contained in the CNS National Report for the sixth CNS Review Meeting (CNS-6) was not repeated, and readers are referred to that report for such information.

The report offers an article-by-article review of the situation in the Netherlands as compared with the obligations imposed by the Convention. It shows how the Netherlands meets the obligations of each of the articles established by the Convention, plus the VDNS and the 5 Fukushima challenges.

The numbering of its chapters and sections corresponds to that of the articles in the Convention.

Chapter 2(a) relates to the 'General Provisions'; it contains a description of the existing installations with their main safety characteristics and activities, as required under Article 6.

Chapter 2(b) describes the legislative and regulatory framework, the RB and the responsibility of the LH, as referred to in Articles 7, 8 and 9 respectively.

Chapter 2(c) describes the priority given to safety (Article 10), the financial and human resources (Article 11), the human factors (Article 12), quality assurance (Article 13), the assessment and verification of safety (Article 14), radiation protection (Article 15), and emergency preparedness (Article 16).

Chapter 2(d) describes the safety of installations, in terms of siting (Article 17), design and construction (Article 18) and operation (Article 19).

Several appendices provide further details of the regulations and their applications, and factual data, and references to other relevant material.

¹⁴ Information Circular: Guidelines regarding National Reports under the Convention on Nuclear Safety, INFCIRC/572/Rev.5, 16 January 2015

¹⁵ Vienna Declaration on Nuclear Safety - On principles for the implementation of the objective of the Convention on Nuclear Safety to prevent accidents and mitigate radiological consequences, CNS/DC/2015/2/Rev.1, published February 9, 2015

¹⁶ Following up the Vienna Declaration on Nuclear Safety – An Informal Meeting of Nuclear Regulators in Buenos Aires, BA WS 1_Rev.2 (11/17), 17 November 2015

¹⁷ 'Template to support the drafting of National Reports under the Convention on Nuclear Safety referring to relevant IAEA Safety Requirements', Report of the group of experts, 14 October 2015

¹⁸ Typical examples are events that are less relevant for the current reporting period.

SUMMARY

The Summary of the present report, presents in its Part I the information on the regular CNS-topics expected in a national report to the CNS. Because of the many post-Fukushima Daiichi measures, there is a special Part II in this summary, dedicated to those measures, as proposed in the Minutes of the Officers' Meeting for the 6th Review meeting of 29 October 2012 in Vienna. The Part II is updated to reflect the situation of July 1st 2016. Part III of the summary contains a description of how the Vienna declaration on Nuclear Safety (VDNS) is implemented in the Netherlands.

PART I REGULAR CNS-TOPICS

Changes to legislative and regulatory framework

The basic legislation governing nuclear activities is contained in the Nuclear Energy Act ('Kernenergiewet' or Kew). The Kew is a framework law, which sets out the basic rules on the application of nuclear technology and materials, makes provision for radiation protection, designates the competent authorities and outlines their responsibilities. More detailed legislation is provided by associated Decrees and Ordinances.

Since the publication of the Netherlands' 6th national report to the Convention in 2013, some changes were included in the Nuclear Energy Act; a prominent one establishes that the Minister of Infrastructure and the Environment is now the principal responsible authority for conducting the regulatory process under the Nuclear Energy Act and for the main functions of the Regulatory Body (the responsible Minister used to be the Minister of Economic Affairs). This change took effect by a Royal Decree of May 1st 2015. An other important step will be an other update of the Kew which will legally establish the new Authority for Nuclear Safety and Radiation Protection, the ANVS¹⁹ as an independent administrative authority (Dutch acronym: ZBO²⁰). It is expected that in 2017, the ANVS will have the status of a 'ZBO'. For more information, refer to the section on the RB below.

The ANVS has completed in 2015 the new Dutch Safety Guidelines' for water cooled reactors, with Dutch acronym 'VOBK'²¹. The VOBK consists of an (extensive) introductory part and a technical part, the 'Dutch Safety Requirements', de DSR. The DSR is based on the IAEA Safety Fundamentals, several Safety Requirements guides and some Safety Guides, safety objectives for new NPPs published by WENRA. An annex to the DSR is dedicated to Research Reactors and describes application of the DSR with a graded approach. The DSR takes into account the latest (post-Fukushima) insights and is in line with the European Directive on Nuclear Safety²² and the objectives of the Vienna Declaration on Nuclear Safety (VDNS). In Part III more details are given.

¹⁹ Dutch: 'Autoriteit Nucleaire Veiligheid en Stralingsbescherming', ANVS

²⁰ ZBO, 'Zelfstandig Bestuurs Orgaan' or independent administrative authority.

²¹ VOBK, 'Veilig Ontwerp en het veilig Bedrijven van Kernreactoren', English translation available as 'Safety Guidelines – Guidelines on the Safe Design and Operation of Nuclear Reactors', dated 08-10-2015

²² Directive 2009/71/EURATOM establishing a Community framework for the nuclear safety of nuclear installations, and its amendment, Directive 2014/87/Euratom.

Some Decrees associated with the Nuclear Energy Act contain additional regulations related to the use of nuclear technology and materials. These continue to be updated in the light of ongoing developments. Notable is the ongoing substantial update of the Decree on Radiation Protection (Bs) because of the transposition of Council Directive 2013/59/EURATOM (BSS).

The Council Directive 2009/71/EURATOM of 25 June 2009 establishes a Community framework for the nuclear safety of nuclear installations. In 2011, it was transposed in Dutch regulations²³. The safety objectives of the Directive cover those of the Nuclear Safety Convention and are in some regards more specific and have a larger scope. This Directive was amended by the Council Directive 2014/87/Euratom of 8 July 2014. As is the case in all member states of the European Union, EU regulations have a marked influence on Dutch lawmaking. The transposition of the amended Nuclear Safety Directive²⁴ is being prepared in 2016 and will result in a new Ministerial Ordinance on Nuclear Safety in 2017.

In June 2016 ANVS completed a new guidance document on conventional technical requirements for nuclear installations.

More detailed information on legislation, regulations and recent and expected changes can be found in the sections on Article 7 of the Convention.

Regulatory body - developments

In the present report, the Regulatory Body (RB) is the authority designated by the government as having legal authority for conducting the regulatory processes, including issuing authorizations, supervision and enforcement. In 2015 the various entities that formerly constituted the RB, have largely merged into the one entity, the Authority for Nuclear Safety and Radiation Protection, Dutch acronym ANVS.

Recent history and developments

In the past there were various organisations that together constituted the RB. A resolution requesting the development of the RB into one entity was accepted almost unanimously in Parliament March 2013. The Minister of Economic Affairs, then the principal authority for processes under the Nuclear Energy Act, endorsed the resolution. A proposal to establish one single national Authority for Nuclear Safety and Radiation Protection was prepared, with a legal analysis of the possibilities. Various ministries were involved. The final decision by the Government (in January 2014) was to establish the ANVS as a competent and independent administrative body (Dutch acronym: ZBO) for the regulation of nuclear safety, nuclear security, radiation protection, transport safety, and waste management and emergency preparedness and response. This type of independent administration explicitly satisfies the international requirements (EU-safety directive and IAEA standards). The ANVS picked up its duties from the beginning of 2015 as a directorate of the Ministry of Infrastructure and the Environment. The ANVS will get the formal status of an independent administrative body (ZBO) when the necessary amendment of the Nuclear Energy Act will be in force (2017) From then on the ANVS can be called the competent regulatory authority.

²³ In 2011, implementation was done via a temporary ordinance (Stcrt. 2011, nr.12517), which was made permanent in 2013 (Stcrt. 2013, nr. 14320).

²⁴ The Safety Directive was amended by 'Council Directive 2014/87/Euratom of 8 July 2014 amending Directive 2009/71/Euratom establishing a Community framework for the nuclear safety of nuclear installations'.

Current situation and outlook

Several ministries have responsibilities regarding the Nuclear Energy Act and therefore there are still various organisations that together constitute the RB. However, since beginning of 2015, more than 95% of the RB staff is employed at the above mentioned ANVS.

The Minister of Infrastructure and the Environment (Dutch acronym: IenM²⁵ or I&M) is the principal authority (competent regulatory authority) for conducting the regulatory process under the Nuclear Energy Act and for the main functions of the RB. The ANVS currently is a directorate of the Ministry of Infrastructure and the Environment, and has been mandated to implement tasks on behalf of the competent regulatory authority.

Nuclear installations operate under a licence, awarded after a safety assessment has been carried out. The licence is granted by the Minister of Infrastructure and the Environment under the Nuclear Energy Act. After establishment of the ANVS as a ZBO the ANVS will be the body granting the licenses. More about this can be found in the texts on Articles 7 and 8.

The ANVS faces staffing challenges because of the accumulation of many regulatory activities. Examples are: the coincidence of the implementation of PSR and 'stress test' measures, the digital I&C, current plans for building the new PALLAS research reactor, the upgrade of the research reactor of the Delft University of Technology, and several activities related to the implementation of EU-directives. The ANVS has more tasks than the combined past entities of the RB and its role is growing. Various tasks that in the past were performed by the Ministries are now taken care of by ANVS. In 2014 the IAEA recommended in its IRRS-report to the Government of the Netherlands to make a further analysis of the manpower situation. Also in 2016 during the parliamentary process of the legal establishment of the ANVS, the Minister of Infrastructure and the Environment agreed to perform a study and to inform Parliament about the outcome and decisions regarding staffing in the second half of 2016. It is expected that more information can be provided during the review meeting in 2017.

More information about the RB can be found in the text on Article 8.

Recent considerations on regulatory and safety issues

Borssele NPP

In February 2013 the licence for loading MOX became irrevocable. First fresh MOX fuel was employed in 2014.

The evaluation report of the third Periodic Safety Review (PSR) of the Borssele NPP was received for review by the ANVS by the end of 2013. The implementation of associated identified measures is ongoing. Moreover, there are the post-Fukushima Daiichi measures and the associated implementation plan that has interfaces with PSR-related set of actions. Refer to Part II of this Summary for more on this.

The Borssele NPP has been in operation for over 40 years. In 2013 the LTO-licence became effective. Before the end of 2013 various licence requirements were fulfilled, including the completion of the recommendations from the regulatory evaluation of LTO programme of the Licence Holder. In these recommendations the results of the SALTO mission of May 2012 have been considered. There was a SALTO follow up mission in February 2014.

²⁵ Infrastructuur en Milieu, I&M

With concluding a Covenant in 2006 between the owners of the NPP and the government, several additional conditions were agreed for the continued operation of the NPP until the end of 2033. One of these is that the Borssele NPP will keep belonging to the 25% safest water cooled and water moderated reactors operating in Canada, the European Union and the United States of America. The Borssele Benchmark Committee was established to assess whether Borssele NPP complies with this requirement. The Committee reported its findings for the first time in September 2013. The following report is expected in 2018.

In the summer of 2012, during a new type of in-service inspection conducted for the first time in neighbouring country Belgium, flaw indications were detected in the base metal of the Doel 3 and Tihance 2 reactor pressure vessels (RPVs). Checks carried out in the Netherlands in Borssele NPP, showed that the Borssele RPV does not present defects corresponding to those found in Belgium.

Financial challenges

There are several market developments that affect the profitability of electricity production of the Borssele NPP, posing a financial challenge to the main owner of the plant, the multi-utility company Delta. This situation is now a publicly debated issue. The ANVS is closely monitoring developments, as far as they may be relevant with regard to nuclear safety. More details can be found in the text on Article 11 'Financial and Human Resources'.

At the research location Petten (the site of the HFR Research Reactor) there are issues like the management of legacy wastes that are a financial challenge.

Several financial-economic studies are being conducted by the Government considering various scenarios, the results of which may be available by the end of 2016. It is expected that more information can be provided during the peer review session in 2017.

Challenges with Communication and information exchange with neighbouring countries

A series of incidents at the Belgian nuclear power plants caused unrest in the Netherlands, particularly in the border provinces. A resolution was endorsed by Parliament requesting the Government to improve the communication and information exchange with the population also with regard to incidents in neighbouring countries.

The ANVS and its Belgian counterpart FANC share expertise and experience in regular meetings. Several activities are being undertaken aiming at increasing cooperation and mutual understanding of approaches to various issues. In particular, in January 2016 ANVS inspectors were present as observers during an inspection conducted by FANC inspectors at the Doel NPP in Belgium. Likewise, March 2016 FANC inspectors were present at an inspection at the Borssele NPP in the Netherlands.

As requested by Parliament, and starting in 2016, in its yearly report on incidents in nuclear facilities, the ANVS will include also information on events in neighbouring countries. There are ongoing discussions about the provision of information to national, regional and local authorities and the public regarding events and incidents in neighbouring countries. Possibilities for more extensive involvement in the decision making process is also being investigated.

High Flux Reactor, HFR

This 45 MW_{th} research reactor in Petten is owned by the Joint Research Centre (JRC) of the European Commission. The LH and operator is the company NRG. Currently the 2nd Periodic Safety Review (PSR) is ongoing. Stress test measures are being implemented.

Since publication of the CNS6 report there have been several issues and events that made the management of NRG end 2013 decide to temporarily take out of service all nuclear installations in Petten to check and improve the situation. By February 2014 all facilities had returned to service but a program of improvement measures continued. At the same time the ANVS formally increased the level of supervision. Improvement in the organization have been introduced in 2014 and 2015 and more will come in the coming years.

From 2016 to 2018 there will be a number of IAEA missions, INSARR (2016), ISCA (2017) and LTO (end 2017 or beginning 2018).

More details can be found in the text about Article 6 and in Appendix 7 'High Flux Reactor (HFR)'.

Dutch Safety Board investigation

The Dutch Safety Board (Dutch acronym: OVV) is an independent organisation charged with the task to investigate incidents or accidents and to draw lessons from the results of these investigations. Recently the Dutch Safety Board decided to launch "an investigation into how the Netherlands works with neighbouring countries to prevent and contain incidents with cross-border consequences at nuclear power stations. Border-region residents have been expressing concerns for some time now in the wake of several such incidents. Factors that the Safety Board will be investigating include how the Netherlands and Belgium engage each other in decisions about and supervision over power stations, which information is shared between them and joint precautions the countries are taking in the event of an accident.". Role and responsibilities of the ANVS organization for emergency preparedness and response als well as those of local authorities and Safety Regions will be investigated. Results are expected in the second half of 2017.

Results of international peer review missions and implementation of their findings

In this section a selection of missions and implementation of their findings is presented.

- IRRS mission in November 2014: in preparation, the RB executed an IRRS self assessment in 2013. Improvement actions identified were, e.g., upgrading of the management system to meet requirements of GSR-3 and strengthening the operating and regulatory experience feedback. More information on the IRRS mission can be found in Appendix 8.
- ENSREG Peer Review: in 2014 the National Action Plan was updated and sent to ENSREG and in April 2015 was subject to Peer Review. More details about implementation of the findings are provided in section II of this Summary of the present report.
- WANO Peer Review: the WANO review of 2012 had a followup in 2014 and in 2016 again a WANO mission was held.
- In February 2014 the follow-up of SALTO mission closed the series of SALTO missions at the Borssele NPP.

- OSART: the RB has requested an operational safety review (OSART) mission at the Borssele NPP in line with the IAEA Action Plan on Nuclear Safety. The mission was conducted in September 2014 and contained two extra modules: Independent Safety Culture Assessment (ISCA) and Corporate OSART. There will be a two-stage follow-up (2016 and 2017). Recommendations and more information on the OSART mission can be found in Appendix 8.

Drills, exercises and lessons learned

In the Netherlands every ca. 5 years very large scale exercises for emergency preparedness are current practice. The next one will be in 2017.

Actions on transparency and communication with the public

Parliament is actively informed by the Minister of Infrastructure and the Environment. Besides, ANVS has a dedicated website. The public can post questions and subscribe for a quarterly report. All national reports published following international agreements and European Directives are made publicly available via the Internet and sent to Parliament. In addition to the English version of reports, a Dutch translation (or a Dutch summary) is sometimes provided. When deemed useful, public meetings are organised to inform interested citizens on relevant issues.

Stakeholder involvement is embedded by public consultation during the licencing process and if applicable in the process of the Environmental Impact Assessment (EIA) under the Environmental Protection Act. This process also involves meetings of ANVS, Licence Holder (LH) and the public. The ANVS is stepwise increasing its communication of regulatory decisions to the public (e.g. on licence applications and adequacy of 'stress tests'); these are published with supporting documentation.

The operator and LH presents its activities via local presentations at meetings, dedicated websites and publicly available reports.

Important issues identified in previous report and follow-up

This section is devoted to the main remarks made during the sixth review meeting of the Contracting Parties to the Convention on Nuclear Safety in 2014. Emphasis is given to the remarks made specifically in relation to the Dutch situation.

For questions answered via the CNS-website during the peer review process of 2013/2014, reference is made to the Q&A section of the CNS website, hosted by the IAEA.

During the sixth CNS Review Meeting, several challenges facing the Dutch RB were identified:

- *Establish the new independent Regulatory Body*
Various changes in the regulation, as explained in the text above, have been introduced and will be effective shortly (in 2017).
- *Workload of the Regulatory Body maybe challenged by:*
 - *Modification project OYSTER*
 - *New build research reactor project PALLAS*
 - *Assessment of PSR of Borssele NPP*
 - *Assessment of digital I&C important to safety*
 - *Followup of Long term operation programme*
 - *Preparation and hosting the IRRS mission in 2014*
 - *Implementation of the national action plan (stress test)*

- *Maintaining number and quality of staff (RB and LH)*
For both workload and staffing of the RB reference is made to the introduction part of this report "Regulatory Body - developments". The staffing of the LH is a point of regular attention by ANVS. Reductions of staff cannot be carried out without prior consent by ANVS and there are legal means to order the LH to improve the situation if this is felt necessary. The frequent WANO and OSART missions are providing further reassurance.
- *Emergency preparedness and response - Harmonisation with neighbouring countries.*
This challenge was also identified as one of the challenges by the special rapporteur on Fukushima at the 6th CNS meeting in 2014. Reference is made to the text in art.16 of this report.

During the sixth review meeting, there were also remarks noting "highlights" in the Netherlands:

- The extensive use and decades of experience with the use of Probabilistic Safety Assessments (PSAs), aiding the assessment of potential consequences (and their probability) for the area around the NPP;
- The extensive evaluation programme related to the licence for Long Term Operation (LTO);
- The long-term experience with Periodic Safety Reviews (PSRs) that aid continuous improvement;
- The availability of Severe Accident management Guidelines (SAMGs) for all operational states.

PART II POST-FUKUSHIMA DAIICHI MEASURES

Participation of the Netherlands in international self assessment exercises

The Netherlands has participated fully in the post-Fukushima Daiichi activities led by ENSREG and by the IAEA (under the CNS umbrella). The Licence Holder (EPZ), operating the Borssele NPP, also participated in two post-Fukushima WANO self assessment exercises. The stress test benefited from these WANO self assessments. The results of these assessments are included in the 'stress test' results.

The first National Action Plan (NACP²⁶), was finalized in December 2012 and was subject to European peer review in April 2013, and gave the most complete survey of all post-Fukushima Daiichi actions, that were going to be implemented by the Licence Holder (LH) or by the RB. It should be noted that some actions in the NACP stem from regular Periodic Safety Reviews and other regular safety assessments, rather than from the 'stress test' and the successive peer reviews. The second version of the NACP was published in December 2014 and was subject to European peer review in April 2015.

All reports related to the stress test have been published and can be found on www.ensreg.eu or www.anvs.nl.

Tabulated lists of post-Fukushima Daiichi actions

Section 8 of the NACP gives a tabled summary of the national implementation of post-stress test actions. It features two tables, one table with the Actions initiated by or imposed on LH EPZ, and an other table with Actions mainly for the Regulatory Body (RB). These tables have been reproduced and updated to reflect the situation on July 1st 2016. See Table 5 and Table 6 in Appendix 9 in the present report.

Response on 'Observations and lessons – DG's Report on the Fukushima Daiichi Accident'

The table in Appendix 10 contains the response of the Netherlands on the analysis of the "Observations and lessons" from the Director General Report on the Fukushima Daiichi Accident.

The main conclusion is that most observations and lessons were already in place in The Netherlands before the Fukushima Daiichi accident. Since the '80, e.g., periodic safety reviews and subsequent backfitting have been performed at the Borssele NPP, procedures and dedicated equipment are in place for severe accident management, measures have been taken (e.g. PAR's and filtered venting) to help avoiding containment failure, etc.

Large part of the remaining issues are already part of existing programmes and will be implemented the next years (e.g. implementation of stresstest measures).

The analysis has produced therefore only a limited number of additional issues to act upon. The most important one being the National Strategy for the recovery phase after the emergency. The Netherlands will as a first step closely look at international developments in this area, mainly IAEA/OECD-NEA and countries that have already made progress in this area.

²⁶ Netherlands' NACP, National Action Plan (NACP) for the follow-up of post-Fukushima Daiichi related activities, Report for the ENSREG-led NACP Peer Review Workshop to be held in April 2013

Challenges identified at the 6th CNS meeting by the Special Rapporteur on the lessons of the Fukushima Daiichi accident

In this section the position of the Netherlands regarding the challenges is given.

Challenge 1: How to minimize gaps between Contracting Parties' safety improvements?

- In order to minimize the gaps it is essential that information on safety improvements is actively exchanged between Contracting Parties'. The Netherlands promotes such exchange of information and actively participates in international fora, is involved in several international (and particularly European) organisations, cooperates in several areas with neighbouring countries and since many years invites peer reviews mission to the nuclear installations.

Challenge 2: How to achieve harmonized emergency plans and response measures?

- The Netherlands supports the HERCA-WENRA approach that has been developed in 2015, which offers a harmonised response approach for a lot of countries in Europe.
- Another important development is the increased cooperation with the neighbouring countries about information exchange and public communication in case of emergency. But also in case of minor events that are communicated because of increased transparency, supported by exercises

Challenge 3: How to make better use of operating and regulatory experience, and international peer review services?

- During the 2014 IRRS mission the Netherlands was recommended to create a more structural approach for the use of operating experience (OE) and regulatory experience (RE).
- In the OE area we are working to address this recommendation, using guidance and experience which can be found in IAEA- and NEA-documents. For many years the Netherlands has exchanged information about incidents with KWU-Siemens type reactors with Germany through the bilateral German-Dutch commission and GRS. Since 2013 however the so-called KWUREG club, uniting all nations that have a KWU-type plant, was created with the goal to more closely work together, also on OE.
- The Netherlands proposes to develop a mechanism to disseminate/exchange information about measures taken in NPPs after the occurrence of an event
- In the Netherlands how to structure RE is being discussed. For a small country it is relatively difficult to digest all international developments, so there is a need for a good system to gather information and selection criteria. The Netherlands would welcome international guidance document on this subject. Since all countries with a nuclear programme will have to do the same thing, the Netherlands proposes to explore ways of international or regional cooperation to do this in a more effective way.
- Results of safety research are also input for RE. Also in this case exchange of information, cooperation and guidance documents would be welcome in order to make RE more efficient.

Challenge 4: How to improve regulators' independence, safety culture, transparency and openness?

- The renewed European Nuclear Safety Directive provides the basis for independent regulators. Following the guidance of the Directive could be useful in those countries where independence has not been fully implemented yet.
- In the area of transparency and openness the renewed European Nuclear Safety Directive has set new requirements and (non-binding) guidance has been developed by ENSREG. Also the NEA WGPC produced several documents on this subject. Still, worldwide large differences can be found in the level of transparency and openness regulatory bodies observe.
- Recently OECD/NEA published a green booklet²⁷ about regulatory safety culture. The Netherlands has participated in its production and we will use it as a guidance. It is recommendable that other countries take notice of this booklet.
- The Netherlands would welcome a statement within the framework of the CNS peer review stressing the importance of regulatory safety culture, transparency and openness and sharing best practices on how to achieve these.

Challenge 5: How to engage all countries to commit and participate in international cooperation?

- Since Fukushima the international cooperation and exchange of information has increased quite a bit. As a consequence it has become more challenging (especially for small regulatory bodies) to take good notice of all safety relevant information and to attend all relevant meetings.
- The Netherlands suggests that cooperation mechanisms are developed to overcome this situation

²⁷ 'The Safety Culture of an Effective Nuclear Regulatory Body', OECD/NEA, 2016

PART III VIENNA DECLARATION

In this part of the Summary, the Netherlands report about the implementation of the Vienna Declaration.

1. *New nuclear power plants are to be designed, sited, and constructed, consistent with the objective of preventing accidents in the commissioning and operation and, should an accident occur, mitigating possible releases of radionuclides causing long-term off site contamination and avoiding early radioactive releases or radioactive releases large enough to require long-term protective measures and actions;*

The 2009 EU Nuclear Safety Directive has been updated in 2014 and largely covers the safety objectives of the Vienna Declaration. As required to EU Member States transposition into the Dutch regulatory framework will be completed by mid 2017 (see part I of the summary and the section on Article 7) In the foreseeable future there are only plans for a new research reactor (to replace the High Flux Reactor in Petten) but no plans for new NPPs.

2. *Comprehensive and systematic safety assessments are to be carried out periodically and regularly for existing installations throughout their lifetime in order to identify safety improvements that are oriented to meet the above objective. Reasonably practicable or achievable safety improvements are to be implemented in a timely manner;*

This requirement has been implemented in a general way for all nuclear installations with the transposition of the abovementioned EU Directive (in 2011) . Before that, license conditions required periodic safety reviews (every 10 years and every 2 years) at the Borssele NPP. One of the licence conditions also requires implementation of the identified safety improvements within five years after completion of the evaluation phase (unless this timeframe is not reasonable).

3. *National requirements and regulations for addressing this objective throughout the lifetime of nuclear power plants are to take into account the relevant IAEA Safety Standards and, as appropriate, other good practices as identified inter alia in the Review Meetings of the CNS.*

Apart from the Ministerial Ordinance already mentioned in points 1 and 2, the new Dutch Safety Requirements for new reactors are aiming at the same goal. They have been drawn using IAEA standards, WENRA Objectives for new reactors and will be used as a reference for the next PSR at Borssele NPP (evaluation to be finished 2023). The licence of the NPP contains a set of adapted IAEA requirements and guides, including the one dealing with PSR.

4. *Measures that aim at fulfilling the objective for the existing reactor*

In the chapters dealing with the Articles 14 and 18, and with all details in the Appendix 5 it is shown that through the subsequent PSRs a lot of backfitting measures have been and are being taken that reduce the core damage frequency to a level of modern reactors. The additional measures that are (being) implemented based on the stress test (refer to table in the Summary, Part II) increase robustness of the plant even further. An important further safety improvement, which strengthens the defense-in-depth, to be implemented in 2017, is the in-vessel molten core retention by creating a cooling opportunity of the outside of the reactor vessel. For the coming years the ANVS is looking closely at the development of ideas to stabilize the molten core after vessel melt-through in an existing reactor, using (part of) the functionalities of a core catcher in an adapted way.

CHAPTER 2(A) GENERAL PROVISIONS

ARTICLE 6. EXISTING NUCLEAR INSTALLATIONS

6. Each Contracting Party shall take the appropriate steps to ensure that the safety of nuclear installations existing at the time the Convention enters into force for that Contracting Party is reviewed as soon as possible. When necessary in the context of this Convention, the Contracting Party shall ensure that all reasonably practicable improvements are made as a matter of urgency to upgrade the safety of the nuclear installation. If such upgrading cannot be achieved, plans should be implemented to shut down the nuclear installation as soon as practically possible. The timing of the shut-down may take into account the whole energy context and possible alternatives as well as the social, environmental and economic impact.

This chapter gives the information requested by Article 6 of the Convention. It contains:

- a list of existing installations, as defined in Article 2 of the Convention;
- an overview of safety assessments which have been performed, plus their main results;
- an overview of programmes and measures for upgrading the safety of nuclear installations, where necessary, and/or the timing of shut-downs; and
- a description of the position of the Netherlands with respect to the further operation of the installations, based on a review of safety at the time when the Convention entered into force (i.e. 13 January 1997), plus details of the situation in the Netherlands regarding safety issues since the last review in 2014.

6.1.a Existing installations

The Netherlands has one nuclear power plant in operation: the Borssele NPP (a PWR, Siemens/KWU design). There also is one shut-down plant which already is at an advanced stage of decommissioning (safe enclosure): the Dodewaard NPP (a BWR, GE design, 60 MW_e). In addition there are three research reactors, the largest of which has a thermal power of 45 MW, the High Flux Reactor (HFR) in Petten. One of these research reactors, the smallest one, the LFR²⁸, has been permanently taken out of operation and its decommissioning has started. The HOR research reactor in Delft is being upgraded with extra facilities.

6.1.b Borssele NPP

The Borssele NPP is a two-loop Siemens PWR that has been in commercial operation since 1973. As it is the only NPP now in operation in the Netherlands, the emphasis in the remainder of this report is on this plant. It started with an electrical power of 450 MW_e but a turbine upgrade in 2006 has boosted its net electrical output to about 485 MW_e. The NPP generates some 4% of the Netherlands' electricity demand.

²⁸ This is the Low Flux Reactor (LFR), an Argonaut-type reactor with a maximum thermal power of 30kW. It is operated by its Licence Holder, the Nuclear Research & consultancy Group (NRG) in Petten.

In 1994 Dutch Parliament decided to phase out the plant by 2003. The decision was legally challenged and taken back. Instead, in 2006 a Covenant was signed by operator and owners of the plant and the government, allowing the plant to operate until end 2033 at the latest, under certain conditions.

The operator and Licence Holder (LH) of Borssele NPP is the company EPZ. Delta and Essent/RWE are shareholders of EPZ, and own 70% respectively 30% of the shares.

Technical details of the Borssele NPP are provided by Appendix 5.

6.1.c **Dodewaard NPP**

The Dodewaard NPP was a BWR-type 60 MW_e reactor that operated from 1968 until early 1997. The plant was used for R&D purposes for the utilities and for maintaining nuclear expertise for possible expansion of nuclear power in the Netherlands. On 3 October 1996, the owners of the Dodewaard NPP (SEP: a former alliance of Dutch utilities) decided to shut down the reactor permanently²⁹, because of lack of support for a nuclear programme. The shutdown became effective on 26 March 1997.

In 2002 the LH obtained a licence for 'deferred dismantling' after 40 years of safe enclosure.

In April 2003, all the spent fuel had been removed from the site and had been shipped to Sellafield. April 2005, the construction of the 'safe enclosure' was finished. June 1st, 2005, the 40-years waiting period started under a licence that requires the owner to commence dismantling activities in 2045. The current owner of the Dodewaard NPP (GKN) has no other activities than to maintain the safe enclosure during the waiting period. In 2009, all vitrified waste from reprocessing of Dodewaard's spent fuel was shipped to the national waste management authority, COVRA.

6.1.d **Research Reactors: High Flux Reactor (HFR)**

Although research reactors formally are not subject to the Convention, in this report information is included about the High Flux Reactor (HFR), a relatively 'large' 45 MW_{th} research reactor.

The HFR is a tank-in-pool type reactor commissioned in 1961 and is located in Petten in the province of North Holland. In the 1980s its reactor vessel was replaced. The owner is the Joint Research Centre (JRC) of the European Commission but since January 2005, the LH and operating organisation is the Nuclear Research and consultancy Group (NRG). The HFR is used not only as a neutron source for applied and scientific research, but also for the production of isotopes for medical and industrial applications.

6.1.e **Research Reactors: HOR³⁰ in Delft**

The HOR is an open pool-type research reactor with a thermal power of 2 MW_{th}. It is located in Delft. The owner is the Delft University of Technology. It services education and research purposes. Medical applications are getting more and more attention at the HOR and its associated facilities.

²⁹ The reason for the shut down decision was the lack of support for a nuclear program and the fact that the plant was too small to compete on the liberalised electricity market if its research function was to become obsolete.

³⁰ Dutch: 'Hoger Onderwijs Reactor' (HOR), i.e. 'Higher Education Reactor'

6.1.f Plans for new Research Reactor: PALLAS

A new research reactor (named PALLAS) is under consideration in order to replace the HFR. Plans for PALLAS were initiated by company NRG, current LH and operator of the HFR. A foundation is being established that will conduct all preparatory activities required for the realisation of the new reactor. The national government and the province of North Holland together provided a loan of about 80 Meuro to finalize licensing and design of PALLAS. An important precondition for support is the realisation of a sound business plan and the acquisition of (private) funding for the construction and operation of PALLAS.

6.1.g Project for upgrading of Research Reactor HOR: OYSTER

OYSTER (Optimized Yield for Science, Technology & Education, of Radiation) is the project that will make the applicability of the research reactor, the HOR of the Delft University of Technology ('TU Delft') and the associated neutron scattering equipment much wider, and provide its users with more precise results in a shorter time.

The installation of a liquid hydrogen cold neutron source is an essential element in the project. The reactor core is not to be compacted but still its power will be increased from 2 to 3 MW. The availability of cold neutrons will result in new, more interesting applicability for most of the existing neutron instruments. At the same time, the positron source will increase significantly in brightness.

The project has been contracted in a European competitive dialog procedure (complying with Directive 2004/18/EC). The project is jointly financed by the University and the national government.

The upgrade required a new licence. The LH submitted among others a Safety Analysis Report (SAR) and an Environmental Impact Assessment (EIA) report.

6.2 Overview of safety assessments and other evaluations

6.2.a Borssele NPP

For assessment and verification of safety of the NPP, also refer to the text on Article 14. In that section more complete information on recent Periodic Safety Reviews and post-stress test Actions is given. Also reference is made to Part II of the Summary and Appendix 9, featuring a table with all post-stress test Actions on the part of the LH (i.e. EPZ).

The licence for the Borssele NPP does not have an end date. However, in June 2006 the government and the owners of the plant signed an agreement, the Borssele Covenant, allowing the plant to operate until end 2033 at the latest, under a number of extra conditions (in addition to the licence conditions). Details about the Covenant can be found in Appendix 6. Results of the review by the so-called Benchmark commission can be found in the text on Article 14 and in Appendix 6.

Since the drafting of previous report to the CNS, the following issues require(d) attention of the ANVS:

- The third 10-yearly Periodic Safety Review, PSR, (Dutch: '10-EVA') has been completed. The third PSR evaluation report was received for review by the RB by the end of 2013. A number of PSR-related actions are still ongoing, requiring resources at the NPP and the RB. A number of PSR actions have also been included in the list of post-Fukushima Daiichi Actions. A licence has been granted (2016) to allow for merging various existing licences and allow for various modifications to the installation.

- In 2014 the ANVS published an update to the stress test NAcP showing the progress of all Actions. This edition was subject to Peer Review in April 2015. More information on all scheduled Actions can be found in the text on Article 14 and in the also in the Summary (Part II).
- In the summer of 2012, during a new type of in-service inspection conducted for the first time in neighbouring country Belgium, flaw indications were detected in the base metal of the Doel 3 and Tihange 2 reactor pressure vessels (RPVs). Checks carried out in the Netherlands in Borssele NPP, showed that the Borssele RPV does not present defects corresponding to those found in Belgium. However, this issue and other issues related to events in Belgium still are subject to public debate in the Netherlands.
- EPZ has planned to implement digital I&C of the Reactor Control and Limiting System into the plant. Target is to realize the major part in 2017. Careful consideration must be given to the associated reliability, safety and security.
- Operation of the Borssele plant for 60 years has consequences for the required storage capacity at the COVRA interim radioactive waste storage facility. Vitrified waste from reprocessing of spent fuel of the NPP (and spent fuel of research reactors) is stored in the dedicated HABOG building on the COVRA site, together with non-reprocessed spent fuel of research reactors. The capacity of the modular-design bunker-like building with 1.7 meter thick reinforced concrete walls, will be modularly extended. The associated environmental impact assessment was completed in 2013. The license was granted and currently the building phase is going on.
- During the OSART mission in 2014 it became clear that the NPP staff had lost confidence in the top manager and his deputy. The ANVS and the shareholders shared the same vision for the resolution, leading to a number of organisation changes under an interim CEO and finally a new CEO in 2015.
- Low electricity prices and the following financial challenges are the driver for increased attention by the ANVS on the continuous investment in nuclear safety. Refer to the Summary and the text on Article 11 in the present report for more information on the electricity market conditions and how these affect the NPP.

6.2.b HFR RR

At the past review meetings, several Contracting Parties showed an interest in this research reactor and the particular issues surrounding it. For some technical details and past issues of the HFR refer to Appendix 7 of the present CNS report.

In August 2008 a routine in-service inspection detected jets of gas bubbles in one of the reducers that is part of the primary cooling system. Repair was undertaken, which was concluded in 2010, after which operation was resumed.

End of 2012 there was a new issue with the cooling system, detected during a regular reactor stop. There was an anomaly detected in the interface between the pool cooling system and the primary cooling system. There were no off-site safety risks, but the LH, (i.e. company the NRG) decided not to start the reactor at the end of the stop. Plans of the LH for the repair and system modifications were assessed and approved by the inspectorate of the RB. In June 2013 the HFR returned to service.

End of 2013 NRG's management shut down all of its nuclear facilities for a period of three months as part of the setting up of an improvement programme for its organisation and refurbishing of its ageing facilities. Mid February 2014 all facilities had returned to service, but the programme continued. In parallel to these developments the ANVS formally increased the level of supervision. In September 2015 the nuclear instrumentation detected increased fluctuations well below safety limits. The reactor was shut down in controlled stages. Marginal clearance in one of the reactor's six control rods

was established to be the source of the fluctuations. Since then the control rod assembly process has been improved, and supervision of assembly and quality control have been stepped up.

There are financial challenges, partly related to the management of legacy wastes. These are addressed in the Summary of the present report and are not repeated here.

6.2.c Challenges from plans for new-build, upgrading and other activities of LHs

The ANVS is faced with challenges in terms of assuring the sufficiency of its resources. This is due to the cumulative activities like the current new build initiative (PALLAS project), various projects at the HFR and other nuclear facilities at the Petten research location (OLP³¹), upgrade of the research reactor HOR (OYSTER project) and the various projects at Borssele NPP (post-Fukushima actions, digital I&C, PSR, followup of LTO programme). In addition in 2017 the Topical Peer Review on Ageing Management at one NPP and two RRs has to be carried out. Also activities at the ANVS shall be undertaken for the resolution of the IRRS mission recommendations. More information on staffing of the ANVS can be found in the descriptions under Article 8 'Regulatory Body', and Article 11 'Financial and human resources'.

³¹ Dutch acronym: Onderzoekslocatie Petten, OLP

CHAPTER 2(B) LEGISLATION AND REGULATION

ARTICLE 7.LEGISLATIVE AND REGULATORY FRAMEWORK

7.1 Each Contracting Party shall establish and maintain a legislative and regulatory framework to govern the safety of nuclear installations.

7.2 The legislative and regulatory framework shall provide for:

- i. the establishment of applicable national safety requirements and regulations;**
- ii. a system of licensing with regard to nuclear installations and the prohibition of the operation of a nuclear installation without a licence;**
- iii. a system of regulatory inspection and assessment of nuclear installations to ascertain compliance with applicable regulations and the terms of licences.**

7.1 Legislative and regulatory framework

7.1.a Overview of the legal framework

Structure

The legal framework in the Netherlands with respect to nuclear installations can be presented as a hierarchical structure. Refer to the diagram in Figure 1.

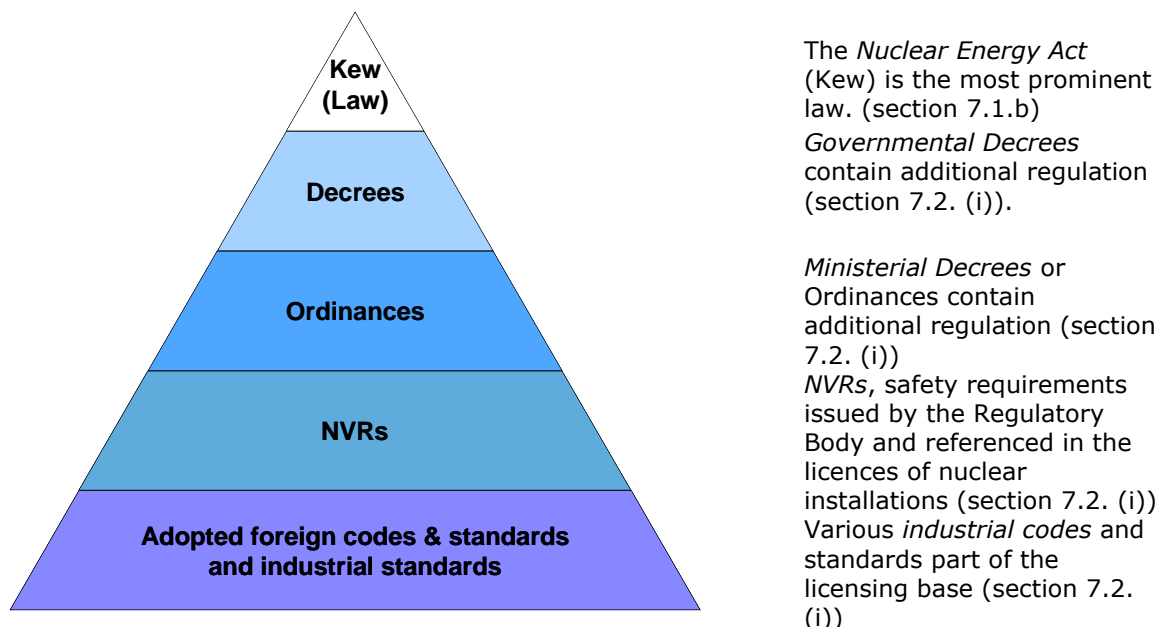

Figure 1 Simplified representation of the hierarchy of the legal framework

In addition to the levels shown in Figure 1, there are international conventions and other legal instruments related to nuclear safety that also apply. Refer to section 7.1.c for more information.

When the ANVS will have been established as an independent administrative authority (2017), it will be authorized to issue 'ANVS – Ordinances'. These will be issued if:

- Guidance or rules are needed on technical or organisational issues.
- Guidance or rules are needed, relevant to nuclear safety, radiation protection and security.
- Governmental Decrees or Ministerial Decrees refer to guidance to be provided in an ANVS Ordinance.

In the hierarchy of the legal framework the ANVS Ordinances will be positioned between the Ministerial Decrees and the NVRs.

Process of establishing arrangements such as laws and other requirements

The Netherlands are a parliamentary democracy. On behalf of the Dutch people, parliament scrutinises the Dutch government and approves laws and can propose lawmaking to the government. The parliament of the Netherlands is called the States General and is bicameral, i.e. it consists of two chambers: the House of Representatives (in Dutch: 'Tweede Kamer der Staten-Generaal') and the Senate ('Eerste Kamer der Staten-Generaal'). General elections for the House of Representatives are held at least every four years.

The government comprises the King, the Prime Minister, and the other ministers. The cabinet is the government, excluding the King, but including the State Secretaries. The cabinet formulates and is accountable for the government's policies.

The Constitution of the Netherlands describes how laws are established, and how the Constitution itself can be amended.

The national legal framework consists of laws, Governmental Decrees and Ministerial Decrees (or Ordinances). In as much as this legal framework concerns nuclear safety, radiation protection or related subjects, new or updated elements therefore are prepared by the competent regulatory authority, i.e. the Regulatory Body.

The majority of laws are introduced to the Parliament by the Government. The members of Parliament can adopt, reject or amend a Bill. Certain laws such as the Nuclear Energy Act (Kew) are a so-called 'framework act' whereby the establishment of the underlying detailed requirements is delegated to the Government, ministers or specific administrative bodies.

The Advisory Division of the Council of State³² provides the Government with independent advice on proposals for new regulations. During the procedure of legislation and regulation, the competent regulatory authority involves the relevant actors such as licence holders, non-governmental organisations (NGOs) and public in this process.

As outlined above, there are laws and underlying regulations like Governmental Decrees that require a vote in Parliament. In addition, there are other Ministerial regulations, the

³² The 'Raad van State', the 'Council of State' has two primary tasks, carried out by two separate divisions. The Advisory Division, as its name implies, advises the government and Parliament on legislation and governance, while the Administrative Jurisdiction Division is the country's highest general administrative court. The basis for these responsibilities can be found in articles 73 and 75 of the Dutch Constitution.

preparation of which is delegated to a minister. These regulations are not submitted to Parliament for a vote. However, a so-called 'preliminary scrutiny procedure'³³ is employed for Ministerial Decrees whereby Parliament is offered an additional opportunity for exercising control.

Responsible authorities

The ANVS is the Regulatory Body (RB), the authority designated by the government as having legal authority for conducting the regulatory processes, including issuing authorizations, supervision and enforcement, and thereby regulating nuclear safety, security, radiation protection, radioactive waste management and transport safety.

The Minister of Infrastructure and the Environment (I&M) is the principal responsible authority for the main functions of the Regulatory Body (RB). Before May 2015, the Minister of Economic Affairs (EZ³⁴) had this role. Refer to the text on Article 8 for more information on the RB and its organisation and position in the regulatory framework.

Several other ministers also have responsibilities in specific areas related to the use of radioactivity and radiation. The following list illustrates the responsibilities of the various ministers regarding the various areas of interest:

- Minister of Infrastructure and the Environment (I&M) for nuclear safety, radiation protection, physical protection of fissile materials and radioactive materials and wastes. This minister is also the so-called coordinating minister for the Act; i.e. minister reporting to Parliament and responsible for the 'maintenance' of the Act. This responsibility has been established by special Decree³⁵.
- Minister of Economic Affairs for radiation protection in the mining industry.
- Minister of Social Affairs and Employment (SZW) for worker safety and health (including radiation protection).
- Minister of Health, Welfare and Sports (VWS) for healthcare and patient safety (including radiation protection).
- Minister of I&M for emissions (including radioactive substances) into surface water.
- Minister of Security and Justice cooperating in the execution of the National Nuclear Emergency Management and Response Plan (NPK).
- Minister of Defence for military applications of ionizing radiation.
- Minister of Finance for insurance and other issues of liability.
- Minister of Foreign Affairs for the coordination of Dutch foreign policy, regarding to the Nuclear Energy Act especially focused on non proliferation and Euratom and IAEA affairs.
- Ministers of Finance and Infrastructure & Environment for the evaluation and approval of financial guarantees regarding the future decommissioning of nuclear reactors.

7.1.b Primary legislative framework: laws

The following are the main laws to which nuclear installations in the Netherlands are subject:

- The Nuclear Energy Act ('Kernenergiewet', Kew);
- The Environmental Protection Act ('Wet milieubeheer', Wm);
- The General Administrative Act ('Algemene wet bestuursrecht', Awb), regulating the procedures under of laws.
- The Act on Liability for Nuclear Accidents ('Wet Aansprakelijkheid Kernongevallen', WAKO);

³³ Dutch: 'voorhangprocedure'

³⁴ Dutch: EZ, 'Economische Zaken' (i.e. Economic Affairs).

³⁵ Royal Decree of 10 april 2015, nr. 2015000645, Stcrt. 2015, 11080

- The Water Act ('Waterwet, Ww');
- Environmental Permitting Act ('Wet algemene bepalingen omgevingsrecht', Wabo).

Other important Acts with relevance for the licencing and operation of nuclear installations are the Act on Government Information ('Wet Openbaarheid van Bestuur', WOB) and the Dutch Safety Regions Act (Wet veiligheidsregio's). In this section, the main elements of the several acts are elaborated. For more information on secondary legislation, like the aforementioned Decrees and NVRs, refer to section 7.2. (i).

Nuclear Energy Act

The basic legislation governing nuclear activities is contained in the Nuclear Energy Act ('Kernenergiewet' or Kew). It is a framework law, which sets out the basic rules on the application of nuclear technology and materials, makes provision for radiation protection, designates the competent authorities and outlines their responsibilities. More detailed legislation is provided by associated Decrees.

The Nuclear Energy Act originally had a twofold purpose: (1) to regulate the use of nuclear energy and radioactive techniques, and (2) to lay down rules for the protection of the public and workers against the associated risks. In practice, however, the law has developed almost entirely to do the latter.

With regard to nuclear energy, the purpose of the Nuclear Energy Act, according to its Article 15b, is to serve the following interests:

- the protection of people, animals, plants and property;
- the security of the state;
- the security and safeguarding of nuclear material;
- the supply of energy³⁶;
- the liability for damage or injury caused to third parties;
- the compliance with international obligations.

Within the framework of the Nuclear Energy Act, fissionable materials are defined as materials containing up to a certain percentage of uranium, plutonium or thorium (i.e. 0.1% uranium or plutonium and 3% thorium by weight). All other materials containing radionuclides and exceeding the exemption levels, are defined as radioactive materials.

Three areas of application

As far as nuclear facilities are concerned, the Nuclear Energy Act covers three distinct areas relating to the handling of fissionable materials and ores: (1) registration, (2) transport and management of such materials, and (3) the operation of facilities and sites at which these materials are stored, used or processed:

(1) The *registration* of fissionable materials and ores is regulated in Sections 13 and 14 of the Nuclear Energy Act; further details are given in a special Decree issued on 8 October 1969 (Bulletin of Acts and Decrees 471). The statutory rules include a reporting requirement under which notice must be given of the presence of stocks of fissionable materials and ores. The Central Import and Export Office, part of the Tax and Customs Administration of the Ministry of Finance, is responsible for maintaining the register.

(2) A licence is required in order to *transport, import, export, be in possession of or dispose* of fissionable materials and ores. This is specified in Section 15a of the Act. The licensing requirements apply to each specific activity mentioned here.

³⁶ This interest will be removed from the Act in 2017.

(3) Licences (LHs) are also required for *building, commissioning, operating and decommissioning* nuclear installations (Section 15b), as well as for nuclear driven ships (Section 15c). To date, the latter category has not been of any practical significance in the Netherlands.

In theory, a licence to build a nuclear installation may be issued separately from a licence to actually commission it. However, the licensing of the construction of a NPP addresses much more than the construction work. Account will have to be taken of all activities to be conducted in the plant, during and after its construction. The authorities need to decide whether the location, design and construction of the plant are suitable, offering sufficient protection of the public and the environment from any danger, damage or nuisance associated with the activities to be conducted in the plant.

In practice, the procedure for issuing a licence to operate a NPP or other nuclear facility will be of limited scope, unless major differences have arisen between the beginning, the completion of the construction work and the commissioning. For example, there may be a considerable difference between the Preliminary Safety Analysis Report (which provides the basis for the construction licence) and the Final Safety Analysis Report (for the operating licence). Views on matters of environmental protection may also have changed over the construction period.

Modifications of licenced plants

Amendments to a licence will be needed where modifications of a plant invalidate the earlier description of it.

The decommissioning of nuclear facilities is regarded as a special form of modification and is treated in a similar way. Refer to section 7.2. (i) for the Bkse decree, that provides more guidance on decommissioning issues.

For minor modifications, a special notification procedure in the Act applies, allowing the LH to modify the facility without a formal amendment to the licence. This notification system can be used only if the consequences of the modification for people and environment are within the limits of the licence.

In addition to the secondary regulations provided by the aforementioned Bkse-decree on the handling of fissionable materials, the Nuclear Energy Act includes a separate chapter (Chapter VI) on intervention and emergency planning and response.

Amendments to the Act

The regulatory framework has seen some changes since the publication of the Netherlands' 6th national report to the Convention in 2013, a prominent one establishing the Minister of Infrastructure and the Environment (I&M) the principal responsible authority for conducting the regulatory process under the Nuclear Energy Act (Kew) and for the main functions of the RB. This change took effect in 2015. An other important step will be an other update of the Kew which will make the newly established Authority for Nuclear Safety and Radiation Protection, the ANVS an independent administrative authority (Dutch acronym: ZBO³⁷). It is expected that in 2017, the ANVS will have the status of a 'ZBO' with its own legal authorities.

Environmental Protection Act (Wm)

In the case of non-nuclear facilities, this Act regulates all environmental issues (e.g. chemical substances, smell and noise); in the case of nuclear installations, the Nuclear Energy Act takes precedence and regulates both conventional and non-conventional environmental issues.

According to this Act and the associated Environmental Impact Assessment Decree, the licensing procedure for the construction of a nuclear facility includes a requirement to draft an Environmental Impact Assessment (EIA) report. In certain circumstances, an EIA is also required if an existing plant is modified. More specifically, it is required in situations involving:

- a change in the type, quantity or enrichment of the fuel used;
- an increase in the release of radioactive effluents;
- an increase in the on-site storage of spent fuel;
- decommissioning;
- any change in the conceptual safety design of the plant that is not covered by the description of the design in the safety analysis report.

The Environmental Protection Act states that under certain conditions, an independent Commission for Environmental Assessments must be established and in these cases it should be consulted when it is decided that an EIA needs to be submitted. For this purpose, there exists a dedicated organisation, named 'Commissie voor de m.e.r.'. On the level of the Decree, the types of activities for which such assessments are required are specified.

The general public and interest groups often use EIAs as a basis for commenting on and raising objections to decisions on nuclear activities. This demonstrates the value of such documents in facilitating public involvement.

General Administrative Act (Awb)

The General Administrative Act sets out the procedure for obtaining a licence and describes the participation of the general public in this procedure (i.e. objections and appeals). It also details the general procedures for the oversight and the enforcement, and related to the latter the possible sanctions. This law applies to virtually all procedures under any law.

Notice must be given, both in the Government Gazette and in the national and local press, of the publication of the draft decision to award a licence. At the same time, copies of the draft decision and of the documents submitted by the applicant must be made

³⁷ ZBO, 'Zelfstandig Bestuurs Orgaan' or independent administrative authority.

available for inspection by the general public. All members of the public are free to lodge written opinions on the draft decision and to ask for a hearing.

All objections made to the draft version of the decision are taken into account in the final version. Stakeholders that have objected to the draft decision are free to appeal to the Council of State (the highest administrative court in the Netherlands) against the decision by which the licence is eventually granted, amended or withdrawn.

Act on the liability for nuclear accidents ('Wet Aansprakelijkheid Kernongevallen', WAKO)

In order to apply the Paris convention on nuclear third party liability and Brussels supplementary convention, the Dutch act on the liability for nuclear accidents implements the parts of these conventions, for which more detailed rules of the contracting parties are necessary. It concerns for instance:

- The maximum amount for which operators of nuclear installations are liable;
- A specification of the kind of financial security which is required.

Some options which the convention leaves to the contracting parties are adopted in the act. For instance:

- The possibility to establish a lower liability for nuclear installations of a low risk nature.
- The possibility to extend the liability to damage caused by a nuclear incident due to a grave natural disaster of an exceptional character.

The act also contains some provisions which offer extra financial protection for the public, apart from the safeguards already offered by the conventions. The most important of these provisions is the state guarantee up to €2,3 billion and a possibility to charge a fee on installations for this guarantee.

A development is the increase of the maximum liability of operators of nuclear installations from €340 million to €1.2 billion (effective since 1st of January 2013). The ministry of Finance intends to increase this maximum liability proportional to the maximum damage that the Insurance Pool in the Netherlands can cover. This would reduce the risk of the State guarantee even further.

Water Act ('Waterwet', Ww)

The purpose of the Act is to prevent and where necessary, limit flooding, swamping and water shortage. Furthermore it is meant to protect and improve the chemical and ecological status of water systems and to allow water systems to fulfil societal functions. Nuclear installations need a permit under the water act to licence their (non-radioactive) discharges to the surface water.

Environmental Permitting (General Provisions) Act (Wabo)

Some 25 existing systems for issuing permits, licences, exemptions and so on for location bound activities which have an impact on our physical environment, have been replaced (October 2010) by a single environmental licence. The main purpose is to establish a single, straightforward procedure with one set of rules for persons or businesses seeking permission for activities which affect the physical environment. This includes one application form to fill in, one single competent authority, one supervision and enforcement authority and one procedure for objections and appeals. The goal is to simplify licensing systems and reduction of expenses for the applicants.

The civil engineering part of the construction of a nuclear installation and local spatial planning aspects will be licenced under the Wabo or the Spatial Planning Act ('Wet

ruimtelijke ordening') by local authorities on the level of towns or rural municipalities. The nuclear safety and radiation protection aspects will be licenced under the Nuclear Energy Act by the Regulatory Body.

Dutch Safety Region Act ('Wet veiligheidsregio's', Wvr)

The Safety Regions Act seeks to achieve an efficient and high-quality organisation of the fire services, medical assistance and crisis management under one regional management board. The Act stipulates that as a common rule, security regions must be structured on the same scale as the police regions. This is in no way a break in trend with practices existing before. Past regulations and legislation already required the municipalities to form regions and the Disasters and Major Accidents Act (Wet rampen en zware ongevallen - Wrzo) assumed that such regions had been established. The Safety Regions Act is thus continuing on the basis of existing structures.

Act on Government Information ('Wet Openbaarheid van Bestuur', WOB)

Under the Dutch Government Information (Public Access) Act, any person can request information related to an administrative matter as contained in documents held by public authorities or companies carrying out work for a public authority. As a basic principle, information held by public authorities is public, excluding information covered by the exceptions enumerated in the Act.

7.1.c Ratification of international conventions and legal instruments related to nuclear safety

In addition to the CNS, The Netherlands is party to many other Treaties and Conventions relating to the use of nuclear technology and radioactive materials. This is illustrated by the following list.

- *Non-proliferation*: The Netherlands is party to the 'Treaty on the Non-Proliferation of Nuclear Weapons' (NPT), the non-proliferation treaty of the UN. Related to this are the guidelines from the 'Nuclear Suppliers Group' that lay down restrictions on the transfer of sensitive nuclear techniques such as enrichment and reprocessing. In addition, the Netherlands is affiliated to the 'Proliferation Security Initiative' (PSI), based on Resolution 1540 of the UN Security Council for the Non-proliferation of Weapons of Mass Destruction³⁸.
- *Liability* : The Netherlands is party to a series of UN Treaties on liability, including the Paris Convention³⁹ and supplementing convention to the Convention of Paris, established in Brussels, and the joint protocol concerning the application of the Vienna Convention and the Paris Convention.
- *Nuclear safety*: The Netherlands is party to the UN Convention on Nuclear Safety, the CNS.
- *(Radioactive) Waste management*: The Netherlands is party to the Joint Convention on the Safety of Spent Fuel Management and the Safety of Radioactive waste management⁴⁰.
- *Physical protection*: The Netherlands is party to the Convention on Physical Protection of Nuclear Material and Nuclear Facilities⁴¹. In addition the Netherlands has also expressed its support for the following 'Codes of Conduct':

³⁸ UN Security Council Resolution 1540 (UNSCR 1540) for the non-proliferation of Weapons of Mass Destruction (WMD)

³⁹ 'Paris Convention on Third Party Liability in the Field of Nuclear Energy'

⁴⁰ Joint Convention on the Safety of Spent Fuel Management and on the Safety of Radioactive Waste Management, (JC)

-
- 'Code of Conduct on the Safety and Security of Radioactive Sources' (published 2004, IAEA)
 - 'Code of Conduct on the Safety of Research Reactors' (published 2004, IAEA).

For all EU countries, EU legislation has a large impact on the national legislation. Examples are given below.

The Netherlands has transposed Council Directive 2009/71/EURATOM of 25 June 2009 on nuclear safety in its national legislation force⁴² in 2011. The safety objectives of the Directive cover those of the Nuclear Safety Convention and are in some regards more specific and have a larger scope.

The Directive 2009/71/EURATOM prescribes the systematic evaluation and investigation of the nuclear safety of nuclear installations during their operating life possibly leading to changes in the installation ('continuous improvement'). Also, the regulation prescribes inter alia that:

- LHs should give sufficient priority to nuclear safety systems;
- LHs must provide adequate human and financial resources to meet the obligations on the nuclear safety of a nuclear installation;
- All parties, including the LH, are required to provide a mechanism for educating and training their staff responsible for the safety of nuclear plants to meet the expertise and competence in the field of nuclear safety to be maintained and developed.

The transposition of the amended Nuclear Safety Directive⁴³ is being prepared in 2016. In the Ministerial Ordinance on nuclear safety that will be in force in 2017 the new elements of the amended Directive will be included such as the high level Community nuclear safety objective and the concept of defence-in-depth.

The Netherlands has transposed Council Directive 2011/70/EURATOM of 19 July 2011 'establishing a Community framework for the responsible and safe management of spent fuel and radioactive waste'. Directive 2011/70/Euratom has been fully implemented in the Radiation Protection Decree (Article 20h) and in the Nuclear Installations, Fissionable Materials and Ores Decree (Article 40a). The Netherlands has drafted the required 'National Programme' according to the definition provided by this Directive. This is out of the scope of the present report to the CNS. More information on implementation of this Directive will be reported in future national reports for the 'Joint Convention on the Safety of Spent Fuel Management and on the Safety of Radioactive Waste Management'.

⁴¹ Convention on Physical Protection of Nuclear Material and Nuclear Facilities. This is the amended version of the Convention on Physical Protection of Nuclear Material (CPPNM), the amendment having entered into force on 8 May 2016.

⁴² Regulation of the Minister of Economic Affairs, Agriculture (EL&I) and Innovation and the Minister of Social Affairs and Labour of 18 July 2011, No WJZ/11014550, concerning the implementation of Directive No 2009/71/Euratom of the Council of the European Union 25 June 2009 establishing a Community framework for nuclear safety of nuclear installations (PB EU L 172/18). In 2011, implementation was done via a temporary ordinance (Stcrt. 2011, nr.12517), which was made permanent in 2013 (Stcrt. 2013, nr. 14320).

⁴³ The Safety Directive was amended by 'Council Directive 2014/87/Euratom of 8 July 2014 amending Directive 2009/71/Euratom establishing a Community framework for the nuclear safety of nuclear installations'.

The Netherlands is in the process of transposing Council Directive 2013/59/EURATOM of 5 December 2013 laying down basic safety standards for protection against the dangers arising from exposure to ionising radiation, and repealing Directives 89/618/Euratom, 90/641/Euratom, 96/29/Euratom, 97/43/Euratom and 2003/122/Euratom. This is a major task for the RB. For more information on this, refer to the section 7.2. (i) in which more information can be found on the Radiation Protection Decree which will see major changes because of the aforementioned implementation of Directive 2013/59.

7.1.d **Special agreements**

Special agreements - the 2006 Covenant

The Dutch government in 2006 signed an agreement (Covenant) with the owners of the Borssele NPP, which allows for operation until the end of 2033, if next to the requirements of the operating licence additional requirements specified in the Covenant keep being met. The legal status of the agreement is such, that it can not easily be challenged by future policies on nuclear power. One requirement is that the Borssele NPP keeps belonging to the top-25% in safety of the fleet of water-cooled and water-moderated reactors in the European Union, Canada and the USA. To assess whether Borssele NPP meets this requirement, the Borssele Benchmark Committee has been established.

Also refer to the text on Article 14 and Appendix 6 for more information on the Covenant and a short discussion on the tasks of the 'Borssele Benchmark Commission' and its recent activities.

Special agreements – reprocessing spent fuel

In July 2006 new French legislation entered into force, which prescribes that a return-scheme for the radioactive waste has to be formalised at the moment the spent fuel is sent to France. This condition also applies to the spent fuel that should be sent to France under the current contract between the operator of the Borssele NPP and AREVA.

In response a (new) bilateral agreement between the governments of the Netherlands and France was concluded. The Dutch government started the formal procedures to arrange this agreement by presenting a proposal to Parliament, establishing a return-scheme for the spent fuel under the current reprocessing contract. In 2009 the bilateral agreement between France and the Netherlands was signed. Parliament accepted the agreement by law of May 20th 2010⁴⁴. A new treaty was signed by the Republic of France and the Kingdom of the Netherlands on April 20, 2012, regulating for Dutch spent fuel (SF) produced after 2015, its receipt by Areva NC⁴⁵ in France, its reprocessing and the return of radioactive wastes from reprocessing to the Netherlands before 31 December 2052. The Parliamentary discussion of the enabling law for this treaty was finished in 2013. The law was approved and published in the Government Gazette⁴⁶ and entered into force January 1st 2014.

⁴⁴ Published in Government Gazette, year 2010, No. 238

⁴⁵ AREVA NC: AREVA Nuclear Cycle, subsidiary of the AREVA Group. The subsidiary provides services in all stages of the uranium fuel cycle.

⁴⁶ Stb. 2013, 463

7.2 Provisions in the legislative and regulatory framework

7.2. (i) National safety requirements and regulations

This section describes the regulatory framework, that is sitting below the top-level (laws) of the legal hierarchy. Refer to section 7.1.a for the complete overview of the framework and the processes for establishing the elements of the framework. In short there are the following categories, that will be discussed in this section:

- (Governmental) Decrees (Dutch: 'Besluiten');
- Ordinances or Ministerial Decrees (Dutch: 'Ministeriële regelingen');
- In the near future: ANVS regulations;
- Dutch Safety Requirements, (like the 'Nucleaire Veiligheidsregels', NVRs);
- Guidelines on various issues, published by the ANVS to aid LHs to meet the RB's expectations. When needed, these can be referred to in the licence conditions and as such become part of these. An example of a guideline is the 'VOBK⁴⁷', the Guidelines on the Safe Design and Operation of Nuclear Reactors - Safety Guidelines for short;
- Codes and Standards of industry and NPP Operators.

For each category, first the current situation is described, after which recent and planned developments are addressed.

Governmental Decrees ('Besluiten')

A number of Governmental Decrees⁴⁸ have been issued containing additional regulations and these continue to be updated in the light of ongoing developments. Important examples of these in relation to the safety aspects of nuclear installations are:

- the Nuclear Installations, Fissionable Materials and Ores Decree (Bkse);
- the Radiation Protection Decree (Bs);
- the Transport of Fissionable Materials, Ores and Radioactive Substances Decree (Bvser);
- the Environmental Impact Assessment Decree.

The Nuclear Installations, Fissionable Materials and Ores Decree (Bkse) regulates all practices involving fissionable materials and nuclear facilities (including licensing). The Radiation Protection Decree (Bs) regulates the protection of the public (including patients) and workers against the hazards of all ionising radiation. It also establishes a licensing system for the use of radioactive materials and radiation-emitting devices, and prescribes general rules for their application. The Transport of Fissionable Materials, Ores and Radioactive Substances Decree (Bvser) deals with the import, export and domestic transport of fissionable materials, ores and radioactive substances by means of a reporting and licensing system.

The Nuclear Energy Act and the aforementioned Decrees are fully in compliance with the relevant Euratom Directive laying down the basic safety standards for the protection of workers and the general public against the health risks associated with ionising radiation. This Directive (96/29/Euratom) is incorporated into the relevant Dutch regulations.

As explained in section 7.1.c the Netherlands is transposing Directive 2013/59/Euratom, which will have a major impact on the Radiation Protection Decree, but also some impact on other Decrees.

⁴⁷ Dutch: Veilig Ontwerp en het veilig Bedrijven van Kernreactoren, VOBK

⁴⁸ In Dutch legislation they belong to the category: 'Algemene maatregelen van bestuur'

The Environmental Impact Assessment Decree, in combination with the Environmental Protection Act, stipulates that in certain circumstances a licence application for a nuclear installation shall be accompanied by an EIA. This complies with EU Council Directive 97/11/EC.

Current regulation already provides for limited reimbursement of the RB for the costs of oversight and licencing. The LHs pay an annual fee and on top of this there are fees for individual licencing activities. However, currently only a limited fraction of the annual budget of the RB is collected. The objective is to increase this fraction in the coming years. Therefore new reimbursement regulation⁴⁹ was drafted. In the new Decree the financial contribution from the nuclear installations was increased to 22 % cost coverage. The associated Decree entered into force on January 1st 2014. It will be evaluated in the second part of 2016 in order to determine if the contributions of the nuclear installations can be further increased.

In the next paragraphs, some details of the various existing Decrees are addressed.

Radiation Protection Decree ('Besluit stralingsbescherming', Bs)

The Bs and dose criteria for normal operation

The main elements of the Bs are: (1) justification of the activity, (2) optimization - ALARA and (3) dose limits.

Practices involving ionizing radiation should be justified. Dutch regulation features a list of 'justified and not justified practices'.

The exposure to ionising radiation should be kept As Low As Reasonably Achievable (ALARA). The ALARA principle is recorded in the Nuclear Energy Act (article 15 and 31 of that law), the Bs Decree and also in the Bkse Decree.

The dose limit for members of the public is a maximum total individual dose of 1 mSv and 20 mSv for workers in any given year as a consequence of normal operation from all anthropogenic sources emitting ionising radiation (i.e. NPPs, isotope laboratories, sealed sources, X-ray machines, industries, etc.).

For a single source (for instance a single NPP), the maximum individual dose is set at 0.1 mSv per annum.

The RB is preparing the implementation of Directive 2013/59/EURATOM of 5 December 2013 laying down basic safety standards for protection against the dangers arising from exposure to ionising radiation, and repealing Directives 89/618/Euratom, 90/641/Euratom, 96/29/Euratom, 97/43/Euratom and 2003/122/Euratom. This is a major task, as it is used as an opportunity for a major rewrite and restructuring of the current radiation protection Governmental Decree.

Nuclear Installations, Fissionable Materials and Ores Decree ('Besluit kerninstallaties, splijtstoffen en ertsen', Bkse)

The Bkse and licensing construction, commissioning & operation

The Bkse sets out additional regulations in relation to a number of areas, including the licence application for the construction, commissioning and operation of a nuclear reactor, and associated requirements. According to article 6 of Bkse, for such an application, applicants are required to submit (among others) the following information:

- a description of the site where the installation is to be located, including a statement of all relevant geographical, geological, climatological and other conditions;

⁴⁹ Dutch working title: 'Besluit Vergoedingen Kernenergiwet'

- a description of the installation, including the equipment to be used in it, the mode of operation of the installation and the equipment, a list of the names of the suppliers of those components which have a bearing on the assessment of the safety aspects, and a specification of the installation's maximum thermal power;
- a statement of the chemical and physical condition, the shape, the content and the degree of enrichment of the fissionable materials which are to be used in the installation, specifying the maximum quantities of the various fissionable materials that will be present at any one time;
- a description of the way in which the applicant intends to manage the relevant fissionable materials after their use;
- a description of the measures to be taken either by or on behalf of the applicant so as to prevent harm or detriment or to reduce the risk of harm or detriment, including measures to prevent any harm or detriment caused outside the installation during normal operation, and to prevent any harm or detriment arising from the Postulated Initiating Events (PIEs) referred to in the description, as well as a radiological accident analysis concerning the harm or detriment likely to be caused outside the installation as a result of those events (safety analysis report);
- a risk analysis concerning the harm or detriment likely to be caused outside the installation as a result of severe accidents (Probabilistic Safety Analyses);

The Bkse and decommissioning

Bkse includes legislation on decommissioning and financial provisions for the costs of decommissioning. An important part of this legislation was based on the WENRA⁵⁰ Safety Reference Levels on decommissioning.

Bkse requires the LH to have and periodically (every five years) update a decommissioning plan during the lifetime of the facility and submit it to the authorities for its evaluation and decision on approval. Bkse specifies the minimum requirements on the content of the decommissioning plan. The decommissioning plan serves as the safety-basis for all the activities carried during the decommissioning phase, and it provides the basis for the financial provisions for the decommissioning costs.

Furthermore, the LH is required to have a financial provision to cover the costs of decommissioning, which will have to be updated and approved by the authorities every time the decommissioning plan is updated. The LH is in principle free to choose the form of the financial provision. Upon approval, the authorities will assess whether the financial provision offers sufficient security that the decommissioning costs are covered at the moment of decommissioning.

For the application for a decommissioning licence, according to Bkse, the LH shall submit the following information to the authorities:

- a copy of the operating licence;
- a decommissioning plan;
- a description of the measures to be taken either by or on behalf of the applicant so as to prevent harm or detriment or to reduce the risk of harm or detriment, including measures to prevent any harm or detriment caused outside the facility during normal operation, and to prevent any harm or detriment arising from the Postulated Initiating Events (PIEs) referred to in the description, as well as a radiological accident analysis concerning the harm or detriment likely to be caused outside the installation as a result of those events (Safety Analysis Report);

⁵⁰ Western European Safety Regulators Association, WENRA.

- a risk analysis concerning the harm or detriment likely to be caused outside the installation as a result of severe accidents.

The Bkse and the Community framework for nuclear safety

Council Directive 2009/71/Euratom establishes a (European) Community framework for nuclear safety of nuclear installations. It has been transposed in Dutch regulation and as such has had its impact on the Bkse-decree. The safety objectives of this (European) Council Directive cover those of the Nuclear Safety Convention and are in some regards more specific and have a larger scope.

The Bkse and the risk criteria for incidents and accidents

The Netherlands has a policy⁵¹ on tolerance of risks posed by any hazardous activity and including also nuclear power stations. This policy has been formulated independently of the Nuclear Safety Requirements (the 'NVRs') and is primarily incorporated in the Bkse Decree.

The basis and application of the regulations are discussed in some detail in Appendix 1, which includes more detailed references to official documents (Acts, Decrees, etc.). As far as the radiological hazard is concerned, the regulations can be seen as implementing the IAEA Fundamental Safety Standards (IAEA SF-1), in particular implementing the primary 'Safety Objective': '*The fundamental safety objective is to protect people and the environment*'.

The application according to Bkse of this objective requires the LH to:

- verify that pre-set criteria and objectives for individual and societal risk have been met. This includes identifying, quantifying and assessing the risk;
- reduce the risk, if required, until an optimum level is reached (based on the ALARA principle);
- exercise control, i.e. maintain the level of risk at this optimum level.

Bkse and Risk criteria (1): Individual risk

In accordance with the probabilistic acceptance criteria for individual mortality risk as laid down in Bkse, the maximum permissible level for the individual mortality risk (i.e. acute and/or late death) has been set at 10^{-5} per annum for all sources together and 10^{-6} per annum for any single source. These numerical criteria were developed as part of general Dutch risk management policy in the late eighties of the 20th century. Based on an average annual mortality risk of 10^{-4} per annum for the least sensitive (highest life expectancy) population group (i.e. youngsters around 12 years old from all causes, it was decided that any industrial activity should not add more than 1% to this risk. Hence, 10^{-6} per annum was selected as the maximum permissible additional risk per installation. Furthermore, it is assumed that nobody will be exposed to risk from more than 10 installations and the permissible cumulative individual mortality risk is therefore set at 10^{-5} per annum.

Bkse and Risk criteria (2): Group or societal risk

Where severe accidents are concerned, it is necessary to consider not only the individual mortality risk but also the group risk ('societal risk'). In order to avoid large-scale disruption to society, the probability of an accident in which at least 10 people suffer acute death is restricted to a level of 10^{-5} per annum. If the number of fatalities increases by a factor of n , the probability should decrease by a factor of n^2 . Acute death means death within a few weeks; long-term effects are not included in the calculation of group risk.

⁵¹ Formulated by the former ministry of VROM

Bkse and Risk criteria: taking account of countermeasures

In demonstrating compliance with the risk criteria, it is required to assume in the supporting analysis that only the usual forms of mitigating measures are taken (i.e. action by fire services, hospitals, etc.). Although the emergency preparedness organisation may take special measures like evacuation, iodine prophylaxis and sheltering, these are disregarded in the Probabilistic Safety Analysis (PSA). In fact it is assumed that any countermeasure will never be 100% effective. It is more realistic to expect that a substantial part of the population will be unable or unwilling to adopt the prescribed countermeasure(s). The PSA results used to demonstrate compliance with the risk criteria, therefore need to reflect this more conservative assumption⁵².

See Appendix 1 for a discussion of the abovementioned dose- and risk criteria and their background.

Ministerial Decrees or Ordinances ('Ministeriële Regelingen, MR');

Ordinances or 'Ministerial Decrees' are issued by the Minister of Infrastructure and the Environment (I&M) and are mandatory for all nuclear installations and activities. In this section, only developments regarding ordinances are discussed.

Ministerial Decree on the implementation of Directive nr 2009/71/EURATOM

The Netherlands has brought Council Directive 2009/71/EURATOM of 25 June 2009 on nuclear safety into force on July 22, 2011. It was implemented in Dutch regulations via an ordinance. For more information, refer to section 7.1.c.

Ministerial Decree on 'Physical protection of radioactive sources'

This new regulation entered into force at April 2013 and was introduced to strengthen the physical protection of (non-nuclear) radioactive materials in order to reduce the risk of misuse of these materials. This goal is also formulated by the IAEA Code Of Conduct and by the CBRN-Actionplan of the European Commission. The regulation is based on the recommendations of "Security of Radioactive Sources" (IAEA Nuclear Security Series No.11). This regulation is now a part of the Regulation implementation radiation protection (chapter 6). It will be evaluated in 2016/2017.

Ministerial Decree on Physical protection of nuclear facilities and fissionable materials - update

The Ministerial Decree on security of nuclear facilities and nuclear fuel came into force in January 2011. Based on this Decree the nuclear facilities have adjusted their security plans. The regulation will be adapted to the changes incorporated in revision 5 of INFCIRC 225 (NSS 13). It is expected that the revised regulation will be approved of in October 2016.

Ministerial Decree on (nuclear) pressure equipment

This Ministerial Decree entered into force on 1 January 2008 and addresses the qualification of nuclear pressure equipment. The Decree among others defines the qualifications required for Notified Bodies to inspect pressure equipment under supervision of the RB and perform these inspections in accordance with the European Pressure Equipment Directive.

Regulations and guides issued by Regulatory Body*The Nuclear Safety Rules (NVRs)*

The Nuclear Energy Act (Article 21.1) provides the basis for a system of more detailed

⁵² However, for the sake of interest, the PSA results of the Dutch NPP show both situations: with and without credit being given for countermeasures.

safety regulations concerning the design, operation and quality assurance of nuclear power plants. These are referred to as the Nuclear Safety Rules (Dutch: 'Nucleaire VeiligheidsRegels', NVRs). The regulations of the NVRs apply to an installation or nuclear facility, as far as they are referenced in their licences. This mechanism allows the ANVS to enforce the NVRs. The practice of including requirements in the licence is suitable for a country like the Netherlands with a very small number of nuclear facilities and only one operating NPP.

However, the NVRs on quality assurance for NPPs have been implemented as a Ministerial Decree and are based on the IAEA Safety Series (50-C/SG-Q), where necessary amended for specific use in the Netherlands.

NVRs, adapted to the use in the Dutch NPP

The NVRs are based on the Safety Standards and Guides issued by the IAEA. Using an agreed working method, these IAEA documents have been studied to determine how they can be applied in the Netherlands. This procedure has resulted in a series of adaptations (termed 'amendments') to the IAEA documents, which then have become the draft NVRs. The amendments have been formulated for various reasons: to allow a more precise choice out of different options, to give further guidance, to be more precise, to be more stringent, or to adapt the wordings to specific Dutch circumstances like risk of flooding, population density, seismic activity and local industrial practices.

At the Safety Requirements level, the NVRs are strict requirements which must be followed in detail. At the Safety Guides level, the NVRs are less stringent: alternative methods may be used to achieve the same safety levels.

NVRs, history of their development

The first set of formally established NVRs was based on the original NUSS programme. However, in 1996 the IAEA launched a major programme to review and update the existing IAEA standards. The revised standards began to be published in the year 2000. At the time, implementation of the new standards was not considered to be particularly necessary in the Netherlands, given that the only NPP still in operation was then expected to shut down in 2003. A gradual change in politics took place leading first to moving this date to 2013 and later on to an agreement (the Covenant) allowing operation until the end of 2033 at the latest under additional preconditions. Refer to Appendix 6 about 'the Borssele Covenant'.

After these changes had taken place, the need for revision of the NVRs became obvious. Finally in 2010 a new set of NVR's was finished and applied as license condition in 2011 when the MOX-license was granted. This set also includes the WENRA Safety Reference Level (SRL) version 2008.

Appendix 4 contains a table of the current NVRs and related IAEA Safety Standards and Safety Guides as applicable (amended) for the purpose of the licence of the Borssele NPP.

VOBK

October 2015 the ANVS published the VOBK⁵³, the Guidelines on the Safe Design and Operation of Nuclear Reactors - Safety Guidelines for short. These Guidelines provide new reactor licence applicants with detailed insight into what the ANVS considers to be the best available technology.

It consists of an (extensive) introductory part and a technical part, the 'Dutch Safety Requirements', de DSR. The DSR part is based on the IAEA Safety Fundamentals, several

⁵³ Dutch: Veilig Ontwerp en het veilig Bedrijven van Kernreactoren, VOBK

IAEA Safety Requirements guides and some IAEA Safety Guides, safety objectives for new reactors published by WENRA and some other reputed sources. An annex to the DSR is dedicated to Research Reactors.

The DSR thus is the more technical part of the VOBK. It is applicable to existing nuclear power reactors as far as reasonably achievable and in line with the objective of continuous improvement. There is an annex to the DSR dedicated to Research Reactors (RRs). The application of this annex to new and existing research reactors will have a graded approach. The development of the DSR was a major effort of the ANVS. Assistance was contracted from a foreign TSO.

The DSR describes a major part of the required processes and regulations for the licensing of NPPs. This will contribute to establishing a new and well structured regulatory framework.

More information about the VOBK and the DSR is provided in Appendix 1.

WENRA SRL VERSION 2014

Self-assessment has been carried out to determine which SRLs are not yet covered by the regulatory framework. The preliminary result is that 27 SRLs are not yet implemented, mainly in the issues F, LM, R and T. According to the gentlemen's agreement of WENRA they should be implemented in 2017.

GUIDANCE ON CONVENTIONAL SAFETY

In 2016 the ANVS published a new guidance document on conventional technical requirements for nuclear installations. This guidance document deals with non-nuclear aspects like noise, conventional waste, dangerous goods et cetera.

Adopted foreign nuclear codes and standards

The experience with the IAEA-based NVRs has been generally positive, although they have not proved to be a panacea for all problems related to regulation. Strong points are the clear top-down structure of the IAEA hierarchy⁵⁴ of nuclear and radiation safety Standards and their comprehensiveness. However, given that they are the result of international cooperation, the standards cannot cover all aspects in the detail sometimes offered by some national (nuclear) regulatory systems.

To cope with this difficulty, inspectors and assessors involved with their application, need to have an adequate knowledge of the current state of technology in the various areas relevant to safety. In addition, sometimes additional material is needed to define the licensing basis. Nuclear codes and standards of other countries often are adopted. Examples are the US Code of Federal Regulations, the USNRC Regulatory Guides, the USNRC Standard Review Plan, and the RSK recommendations (German). However, careful consideration needs to be given to application of these foreign standards, since using them out of their original context may lead to difficulties.

Adopted industrial standards

The Safety Guides in the NVR series give guidance on many specific items. However, they do not cover industrial codes and standards. Applicants are therefore required to propose applicable codes and standards, to be reviewed by the RB as part of their applications. Codes and standards in common use in major nuclear countries are

⁵⁴ The Safety Standards Series comprises the following levels of documents: Safety Fundamentals, Safety Requirements and Safety Guides

generally acceptable (e.g. ASME, IEEE and KTA). The RB has the power to formulate additional requirements if necessary.

7.2. (ii) System of licensing

As discussed in the section on Article 7.1 of the Convention, the Nuclear Energy Act stipulates (in Article 15, sub b) that a licence must be obtained to construct, commission, operate, modify or decommission a nuclear power plant or an other nuclear facility. Similarly, the Act states (in Article 15, sub a) that a licence is required to import, export, possess or dispose of fissionable material.

Under Article 29 of the same Act, a licence is required in a number of cases (identified in the Radiation Protection Decree, Bs) for the preparation, transport, possession, import or disposal of radioactive material.

The procedures to obtain a licence under the Nuclear Energy Act (and other acts), follow the guidelines specified in the General Administrative Act (Awb). These procedures allow for public involvement in the licensing process. Any stakeholder is entitled to express his views regarding a proposed activity. The Regulatory Body shall take notice of all views expressed and respond to them with careful reasoning. If the reply is not satisfactory, he RB can be challenged in court.

Principal responsible authority

The authorities relevant with respect to the regulatory process under the Nuclear Energy Act have been described in the section on Article 7.1. In addition to the Nuclear Energy Act, several types of regulation may apply to a nuclear facility and the activities conducted in it and/or supporting it. Therefore often there are several authorities, sometimes at several levels in the governmental organisation involved in the licencing procedures.

Coordination Law

For projects related to large scale energy generation, a special Coordination Law applies. Large scale projects that could be impacted by this law are for instance the construction of power plants with an electrical power greater than 500 MW_e, investment in the power grid, etc. The Coordination Law supposes involvement of the ministry of Economic Affairs (EZ). With such large projects, the ministry of EZ is assumed to be the coordinator, organising the interaction between the many authorities, each of which will perform its duties. Typical of such projects is the involvement of many levels of governmental organisations; from the ministries down to the municipal level.

Advisory bodies

The Health Council of the Netherlands (Gezondheidsraad) is an independent scientific advisory body established under the terms of the Public Health Act. Its remit is to advise the government and Parliament on the current level of knowledge with respect to public health issues and health (services) research, including radiation protection.

To date there is no standing advisory committee on nuclear safety; an advisory committee (the Reactor Safety Commission) is formed on an ad hoc basis as required. The RB at any time can install a Commission dedicated to any required issue.

With a licence application, it very often is compulsory to conduct an Environmental Impact Assessment or EIA (Dutch: milieu-effectrapportage, m.e.r.). It is compulsory for all reactors with a thermal power higher than 1 kW. In the Netherlands has a permanent commission, the Commission for the Environmental Assessment ('Commissie voor de m.e.r.', Cmer) that advises the RB on the requirements of all EIAs conducted in the Netherlands, including those related to nuclear facilities.

Notified bodies

The legal basis for oversight on nuclear pressure equipment has been transferred from the Steam Act to the Nuclear Energy Act. Consequently the prime responsibility for its enforcement is with the ministry of Infrastructure and the Environment and the ANVS. Refer to Article 8 for details on the organisation of the RB.

Notified Bodies under the European Pressure Equipment Directive⁵⁵ can qualify as nuclear pressure equipment inspectorate, if they can demonstrate additional qualifications in design, fabrication and inspection of nuclear pressure equipment. After positive evaluation of the Notified Body by the ANVS, it can be accepted by the Minister of I&M. Under this new system, the LH can select an accepted Notified Body, to inspect his nuclear pressure equipment. Refer to section 7.2. (iii) for more information on Notified Bodies.

Specific licensing issues in the Nuclear Energy Act

Article 15b of the Nuclear Energy Act enumerates the interests for the protection of which a licence may be refused. These interests are listed in section 7.1.a. The licence itself lists the restrictions and conditions imposed to take account of these interests. The licence conditions may include an obligation to satisfy further requirements that may be set later by the RB.

In the case of very minor modifications, the LH may use a special provision in the Act (Article 17) that allows such modifications to be made with a minor licence change. The LH needs only to submit a report describing the intended modification. This instrument can only be used if the consequences of the modification for man and the environment are within the limits of the licence in force. The notification is published and is open to appeal.

The Regulatory Body conducts regular reviews to establish whether the restrictions and conditions under which a licence has been granted are still sufficient to protect workers, the public and the environment, taking account of any developments in nuclear safety that have occurred in the meantime. Should a review indicate that, given the developments, the level of protection can and should be improved; the RB is empowered by the Nuclear Energy Act to amend the restrictions and conditions accordingly. It should be noted that the regular reviews are not the same as the Periodic Safety Reviews (PSRs), which the LH is required to perform periodically.

7.2. (iii) Regulatory assessment and inspections*Entities performing assessments and inspection*

Article 58 of the Nuclear Energy Act states that the responsible minister should entrust designated officials with the task of performing nuclear safety supervision: safety assessment, inspection and enforcement. This is mainly the task of the inspectors of the ANVS in the Netherlands.

Refer to section 8.1.c for a detailed description of the ANVS, its functioning, as well as recent developments.

There is no specific RB for the assessment and inspection of the integrity of pressure retaining components. Companies having the required knowledge and expertise, can qualify as a Notified Body. For developments regarding regulation and inspection of pressurized equipment, refer to the end of section 7.2. (i).

⁵⁵Directive 97/23/EC of the European Parliament and of the Council of 29 May 1997 on the approximation of the laws of the Member States concerning pressure equipment

Regulatory assessment process

The ANVS reviews and assesses the documentation submitted by the applicant. This might be the Environmental Impact Assessment (EIA) report and the Safety Analysis Report (SAR) with underlying safety analyses submitted in the context of a licence renewal application or modification request, proposals for design changes, procedural changes such as the introduction of Severe Accident Management Guidelines (SAMGs), et cetera.

There are proposed changes that are within the boundary of the licence, like requests for minor modifications and changes to the Technical Specifications. The assessments of these are carried out by the ANVS and have no need of a licence modification.

During the licensing phase the ANVS assesses among others, whether the applicable NVRs (i.e. requirements and guidelines for nuclear safety and environment), the requirements and guidelines for security and the regulation for non-nuclear environmental protection have been met and whether the assessments (methods and input data) have been prepared according to the state of the art. The ANVS assesses the radiological consequences associated with postulated transients⁵⁶ and accidents in the various plant categories. The ANVS will verify in particular if the results are permissible in view of the regulations. The expertise enables the ANVS to determine the validity of the (system) analyses and the calculations. The ANVS receives support from a foreign TSO in these activities.

The ANVS lays down the guidelines for the required calculations (data for food consumption, dispersion, etc). Acceptance criteria used in the assessments are specified in Appendix 1. Further details of the assessment process are given in the section on Article 14.

In the final stage of the licencing procedure, the inspectors of ANVS are asked to verify the draft licence including its licence conditions and requirements regarding its appropriateness for enforcement.

Regulatory inspections

The function of regulatory inspections mainly is:

- to check that the LH is acting in compliance with the regulations and conditions set out in the law, the licence, the safety analysis report, the Technical Specifications and any self-imposed requirements;
- to report (to the director of the ANVS) any violation of the licence conditions and if necessary to initiate enforcement action;
- to check that the LH is conducting its activities in accordance with its Safety Management system;
- to check that the LH is conducting its activities in accordance with the best technical means and/or accepted industry standards;
- To check that the LH is committed to continuously improve nuclear safety.

All inspections with regard to nuclear safety, radiological protection of personnel and of the environment around nuclear sites, security and safeguards, including transportation of fresh and spent nuclear fuel and related radioactive waste to and from nuclear installations are carried out by the ANVS.

The LH must act in compliance with the Nuclear Energy Act, the licence and the associated Safety Analysis Report (SAR). The compliance is verified with a system of inspections, audits, assessment of operational monthly reports, and evaluation of

⁵⁶ Anticipated Operational Occurrences

operational occurrences and incidents. Inspection activities are supplemented by international missions. An important piece of information for inspection is the two-yearly safety evaluation report, in which the LH presents its own assessment of performance with respect to the licence base on technical, organisational, personnel and administrative provisions.

The management of inspections is supported by a yearly planning, the reporting of the inspections and the follow-up actions. A number of times per year there are meetings of the management of the LH and the ANVS. The discussions are mainly about general issues relating to supervision activities. More often technical or project meetings between plant staff and inspectorate staff are held, discussing issues or progress in relation with inspection findings or assessment activities. There are also regular inspections of the plants' incident analysis group activities. Once a year a special meeting about human and organisational factors is held with a number of LHs.

Some inspections are characterised by an emphasis on technical judgement and expertise. They are compliance-based, that means that the ANVS investigates whether the LH is acting in accordance with the terms of the licence. Other inspections focus on organisational aspects. There is a need to scrutinise the way the LH has fulfilled its responsibility for safety and to ascertain whether the LH's attitude shows a sufficient awareness of safety aspects.

Upon request of the ANVS, in-depth international team reviews are also carried out by bodies such as the IAEA (OSART, Fire Safety, IPERS, ASSET, IPPAS and INSARR). These reviews are the results of separate decisions mainly on the initiative of the ANVS. ANVS teams carry out smaller team inspections or team audits from time to time. In addition, the Borssele plant itself carries out self-assessments at regular intervals and invites others like WANO to perform assessments (see also section 10.2 and 14.(i)). The self-assessments have been requested by the ANVS.

7.2. (iv) Enforcement

Should there be any serious shortcoming in the actual operation of a nuclear installation, formally the Minister of Infrastructure and the Environment is empowered under Article 37b of the Nuclear Energy Act to take all such measures as deemed necessary, including shutting down the nuclear installation. In effect, the ANVS is the authority mandated to take such measures. In 2017, with ANVS becoming an independent administrative authority, ANVS will be empowered to take such actions. Enforcement procedures have been published describing the action to be taken if this article of the Act needs to be applied. Staff of the ANVS can prepare an official report for the public prosecutor, should the need occur. Other measures can be taken enforcing the conditions of the licence conditions. This is based on among others on Article 83a of the Nuclear Energy Act and on the Economic Offenses Act.

Article 19.1 of the Nuclear Energy Act empowers the ANVS to modify, add or revoke restrictions and conditions in the licence in order to protect the interests on which the licence is based. Article 20a of the Act stipulates that the ANVS is empowered to withdraw the licence, if this is required in order to protect those interests.

Article 18a of the Nuclear Energy Act empowers the ANVS to compel the LH to cooperate in a process of total revision and updating of the licence. This will be necessary if, for instance, the licence has become outdated in the light of numerous technical advances or if new possibilities to even better protect the population have become available since the licence was issued.

ARTICLE 8. REGULATORY BODY

8.1 Each Contracting Party shall establish or designate a Regulatory Body entrusted with the implementation of the legislative and regulatory framework referred to in Article 7, and provided with adequate authority, competence and financial and human resources to fulfil its assigned responsibilities.

8.2 Each Contracting Party shall take the appropriate steps to ensure an effective separation between the functions of the Regulatory Body and those of any other body or organisation concerned with the promotion or utilisation of nuclear energy.

8.1.a General

There is one large entity, the Authority for Nuclear Safety and Radiation Protection (ANVS⁵⁷) and some smaller entities at other ministries that together constitute the RB. However the tasks related to nuclear safety which is the subject of this report are within the scope of the ANVS only. Therefore this report often will refer to the ANVS as the RB. The RB is the authority designated by the government as having legal authority for conducting the regulatory process, including issuing licences, and thereby regulating nuclear, radiation, radioactive waste and transport safety, nuclear security and safeguards.

All nuclear facilities in the Netherlands, including the NPP of Borssele, operate under licence, awarded after a safety assessment has been carried out successfully. Licences are granted by the ANVS under the Nuclear Energy Act.

Legal status

The ANVS is a Directorate of the ministry of Infrastructure and the Environment (I&M). The Minister of I&M is the principal responsible authority for the main functions of the RB. Before that date this role was for the Minister of Economic Affairs (EZ). The legal basis for the supervisory functions of the competent regulatory authority appears in the Nuclear Energy Act. The mandate of the ANVS is also contained in Article 20a of the Decree by the Minister of I&M on the awarding of the mandate, power of attorney and authority to the Secretary General of the Ministry and the department heads⁵⁸.

Following approval and entry into effect of the necessary legislation, (planned in 2017), the ANVS will become what is known as an independent administrative authority (ZBO), with its own legal authorities. The Minister of I&M in that situation will bear ministerial responsibility for the ANVS.

The ANVS brings together expertise in the fields of nuclear safety and radiation protection, emergency preparedness as well as security and safeguards. For each of these subjects, the ANVS is focused on preparing policy and legislation and regulations, the awarding of licences, supervision and enforcement and (public) information. The

⁵⁷ Autoriteit voor Nucleaire Veiligheid en Stralingsbescherming, ANVS

⁵⁸ Decision by the Minister of Infrastructure and the Environment dated 5 December 2011, no. IENM/BSK-2011/159456 relating to adoption of the organisation by the Ministry of Infrastructure and the Environment and the awarding of the mandate, power of attorney and authority to the Secretary General and department heads (Organisation and Mandate Decision Infrastructure and Environment 2012)

ANVS contributes to safety studies and ensures that the Netherlands are well prepared for possible radiation incidents.

8.1.b Entities of the RB

Several ministries have responsibilities regarding the Nuclear Energy Act, the Kew, therefore there are still various organisations that together constitute the RB. However, since beginning of 2015, most of the RB staff is employed at the abovementioned ANVS.

Below the status and tasks of the entities of the RB are summarized:

- The ANVS currently is a directorate of the Ministry of Infrastructure and the Environment, and has been mandated to implement tasks on behalf of the competent regulatory authority. It is envisaged that the ANVS will become an independent administrative authority (ZBO) beginning 2017, following implementation of an amendment to the nuclear energy law. The ANVS has a staff of approximately 120 fte.
The ANVS is involved in the preparation of legislation, formulating policies (excluding energy policy), regulatory requirements, licensing and independent supervision (safety assessment, inspection and enforcement) of compliance by the LH(s) and other actors with the requirements on the safety, security and non-proliferation⁵⁹. Furthermore it has responsibilities regarding advising in the area of emergency preparedness and public information and communication.
- The ministry of Social Affairs & Employment (SZW⁶⁰) has tasks in the area of protection of the safety of workers against exposure to radiation.
- The ministry of Health, Welfare and Sports (VWS⁶¹) has tasks in the area of protection of patients against exposure to radiation.
- The State Supervision of Mines (SdoM, part of ministry of EZ) oversees the safe and environmentally sound exploration and exploitation of natural resources like natural gas and oil.
- The Netherlands Food and Consumer Product Safety Authority (NVWA⁶²) monitors food and consumer products to safeguard public health and animal health and welfare. The Authority controls the whole production chain, from raw materials and processing aids to end products and consumption. The NVWA is an independent agency in the Ministry of Economic Affairs and a delivery agency for the Ministry of Health, Welfare and Sport.
- The Inspectorate of the ministry of I&M (ILT) has general supervision responsibilities for the compliance with the requirements of modal transport regulations.
- Minister of Defence has its inspectorate military healthcare (IMG⁶³) for overseeing a healthy and safe work environment for the civilian and military staff of the ministry of defence. Its scope includes applications of ionizing radiation and accounting for the use of radioactive sources within the military.

Apart from the ANVS, most entities of the RB employ only a limited number of staff for the Kew-related tasks. The ILT and the ANVS operate under the responsibility of the

⁵⁹ These requirements apply to activities and facilities (including nuclear facilities).

⁶⁰ Dutch: 'ministerie van Sociale Zaken en Werkgelegenheid' (SZW), i.e. ministry of social affairs and employment.

⁶¹ Dutch: 'ministerie van Volksgezondheid, Welzijn en Sport' (VWS), i.e. ministry of health, welfare and sport.

⁶² Dutch: 'Nederlandse Voedsel en Waren Autoriteit', NVWA

⁶³ Dutch: 'Inspectie Militaire Gezondheidszorg', IMG

Minister of I&M. All other entities operate under responsibility of their respective Ministers.

In addition to day-to-day contacts between the entities of the RB, there are periodic meetings at managers and directors levels. There is also periodic communication with institutes that provide the RB with expert information.

8.1.c **Regulatory Body – tasks**

The ANVS has several tasks regarding nuclear safety and radiation protection and associated emergency preparedness and security and safeguards as meant in conventions of the IAEA:

- Executing tasks of the Minister of I&M by or under the Nuclear Energy Act;
- Supervising and enforcing compliance with requirements by or under the Nuclear Energy Act;
- Evaluating, preparing and advising on policies and Acts and regulations.

In addition there are the following tasks that the ANVS is mandated to take care of on behalf of the Minister. In 2017 when the ANVS will have the status of an independent administrative authority these tasks will be the responsibility of the ANVS :

- Informing interested parties and the general public;
- Participating in relevant activities of international organisations, as far as related to tasks related to the Nuclear Energy Act;
- Maintaining relationships with comparable foreign authorities and relevant national and international organisations;
- Supporting national organisations with the provision of expertise and knowledge;
- Undertaking research in support of the implementation of its tasks.

Although all inspectors will support the field inspectors, an important part of their job is assessing documents submitted by LHs in accordance with licence requirements. Assessments are performed e.g. in the framework of plant or organisational modifications and periodic safety reviews. Four professionals are available full-time to conduct routine installation inspections and audits (these are the field inspectors). One of these field inspectors is dedicated full time to the inspection of Borssele NPP. However, during refuelling, all field inspectors and a number of experts are involved in the inspections.

Further integration of safety and security inspections is being stimulated and practiced.

The basic key to deploying staff to the different types of nuclear installations is the potential safety risk. But other factors also have their influence, like operational occurrences and incidents, inspection findings or public attention.

8.1.d **Organisation of the ANVS**

The ANVS is part of the RB, however it employs the major part of RB staff. The other bodies that do have authorities according to the Kew have a more limited role according to the Kew than the ANVS. Therefore this section is solely dedicated to the ANVS and its organisation.

Organisation of the authority

At present, the ANVS is led by a General Director and Director and has three departments of operation. The ANVS has a total staff of approximately 120 FTE, excluding its Directors. In implementing its tasks, the ANVS can rely on support from various organisations, listed below in section 8.1.k 'External Technical Support'.

After the amendment to the Nuclear Energy Act that will make a ZBO of the ANVS, a number of notable things will change:

- The Directors will no longer be civil servants, but will be officially named as independent Board Members that will be the factual decision makers of the ANVS.
- The staff of ANVS will remain employed by the ministry of I&M as civil servants but will work for the Board.
- Instead of the current mandate the Board will have several own responsibilities, that will be transferred from the Minister to the Board.

The ANVS is organised in three departments: (1) Nuclear Safety & Security ('Nucleaire Veiligheid en Beveiliging', NVB), (2) Radiation Protection & Emergency Preparedness ('Stralingsbescherming en Crisismanagement', SBC) and (3) Control, Communication & Support ('Sturing, Communicatie en Ondersteuning', SCO). The latter supports the other units in their operation and provides coordination of the many activities of the ANVS. It also manages the public information and communication tasks of the ANVS.

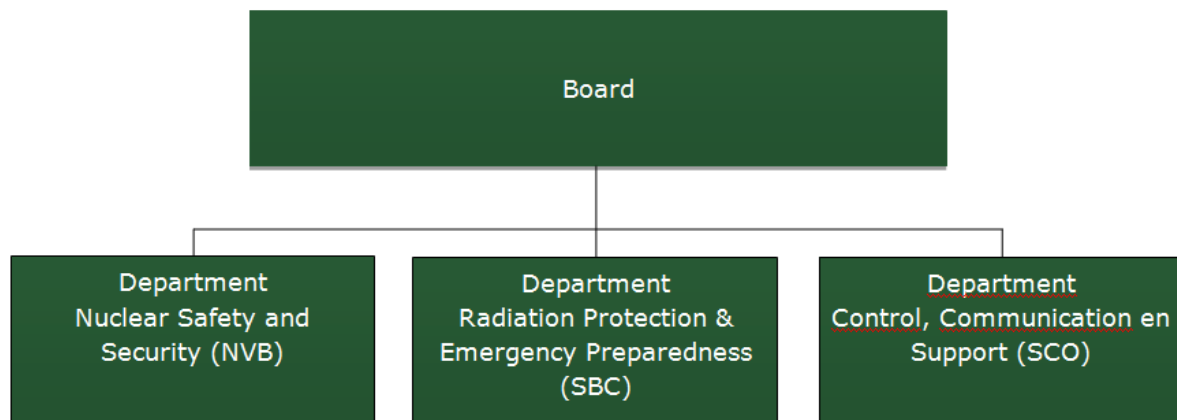

Figure 2 Organisation of the ANVS

By 1st of June 2016 the new detailed internal organisation will come into operation. Each of the three departments NVB, SBC and SCO will have several teams, all lead by team leaders.

The teams of unit NVB:

- Policy and regulations (Beleid en Regelgeving, BR), oversees the consistency in the execution of tasks within the unit NVB and assures the quality of its products with respect to legal aspects.
- Nuclear Installations (Nucleaire Installaties, NI) focuses on a group of LHs: power reactors, research reactors, COVRA and Urenco. The team guards the consistency in the approach the ANVS takes regarding these LHs.
- Nuclear Technology (Nucleaire Techniek, NT) is a team with great expertise on nuclear safety, just like the team NB (see below). Its expertise on Systems Structures and Components can be used by the other teams of NVB but also occasionally by unit SBC. NT and NO will conduct safety assessments and reviews of safety cases, technically challenging inspections and the like.
- Nuclear Operation (Nucleaire Bedrijfsvoering, NB), refer to description of team NT. Focus of NB is more on expertise and experience regarding safe operation, safety

cases, safety analyses, emergency preparedness, organisational aspects, human factors et cetera.

- Security and Safeguards (Beveiliging en Safeguards, BS) executes the statutory tasks of the ANVS regarding security and safeguards.

The teams of the unit SBC:

- Radiation protection and Waste management ('Stralingsbeschermingbeleid en Afvalbeleid', SAB), manages the policy on radiation protection (compliant with European directives) and radioactive waste management including final disposal.
- Crisismanagement and regulations ('Crisismanagement en Regelgeving', CR) is responsible for crisis management during radiation incidents and the related emergency preparedness. In this team there are also lawyers that serve all the teams of SBC.
- Medical and Industrial Applications ('Medische en Industriële Toepassingen', MI), this team manages the licensing of all non-nuclear sources and the inspection and enforcement.
- Transport and support of the unit ('Transport en Afdelingsondersteuning', TA), this team develops policies and regulation for the transport of all nuclear and non-nuclear radioactive sources. It also is responsible for the licensing of these transports and the associated inspection and enforcement. It also is responsible for the certification and validation of transport packages of ADR-class 7. The support staff of the unit SBC is also part of this team; the decision to make them part of TA stems from the desire to have equally sized teams within the unit SBC.

The teams of unit SCO:

- Control and Communication ('Sturing en Communicatie', SC), strategic control of the ANVS organisation with a focus on strategy / strategic and safety culture development, quality assurance of the management system, international coordination, knowledge management, organisational change. Communication with press, stakeholders and the public.
- Support ('Ondersteuning', O), coordination of the operation of the ANVS with information management, provides the secretarial support for Board and management of the ANVS.

8.1.e **Coordination of activities for managing nuclear accidents and incidents**

Refer to the text on Article 16 on Emergency Preparedness for the relevant details.

8.1.f **Development and maintenance of Human Resources at the ANVS**

Consequences of merger of former entities of the RB

The merger of several entities into the ANVS is a large improvement for the development and maintenance of the human resources in most disciplines. All primary functions of the ANVS benefit from that. On the other hand being a larger and independent entity, the ANVS needs to develop also its secondary supporting processes. Moreover, the ANVS has more tasks than the combined past entities of the RB and its role is growing; various tasks that in the past were performed by the Ministries are now taken care of by ANVS. Therefore it is felt that the total number of staff to make a robust and sustainable independent authority is not yet sufficient (refer to section below under '*Manpower situation of the ANVS*').

Disciplines and training

The expertise of the ANVS spans disciplines in areas like radiation protection, nuclear safety, waste safety, transport safety, conventional safety, risk assessment, security and safeguards, emergency preparedness, legal and licensing aspects. Recently it has been

decided that the ANVS will also be responsible for assessing and advising about a number of financial issues. So this discipline has to be developed. Other disciplines that need further development are Research & Development and Public Communication.

Via the ANVS an annual contribution is provided to support the work of the National Institute for Public Health and the Environment (RIVM). RIVM provides scientific support to several ministries including the ministry of I&M but also directly to the ANVS.

For areas in which its competence is not sufficient or where a specific in-depth analysis is needed, the ANVS has a budget at its disposal for contracting external specialists. This is considered one of the basic policies of the ANVS: the core disciplines should be available in-house, while the remaining work is subcontracted to third parties or Technical Service Organisations (TSOs).

The ANVS cooperates with other national and regional authorities and organisations, like the industrial safety inspectorate, the inspectorate of health, several safety regions (including the regional fire brigades), provinces and communities, the national coordinator for terrorism and public safety, and the national crisis center. Also cooperation takes place with inspectorates for the domain of road transport (dangerous good transport supervision) and the domain of air transport (safety culture/safety management).

The ANVS provides tailor-made training for its staff.

Experts have to keep up to date with developments in their discipline. Apart from the general courses, training dedicated to the technical disciplines in the areas of nuclear safety, radiation protection and emergency preparedness is provided. This includes international workshops, but also conferences and visits to other regulatory bodies. In addition there is information exchange through the international networks of OECD/NEA, IAEA, EU etc. To be mentioned are the contributions to HERCA, WENRA, ENSREG, TRANSSC, RASSC, WASSC, NUSSC, EPRSC, NEA/CNRA, NEA/CSNI and several of its Working Groups. In addition there is a policy to participate in several IAEA missions annually, like IRRS, ARTEMIS, IPPAS, INSARR. A new policy is to have staff positioned at IAEA, NEA of EU. Although a lot is happening, the activities to learn from experience (OEF, REF) and knowledge management will be reinforced. A dedicated function for KM has been created. ANVS is also participating in the IAEA Steering Committee on KM and HR for RBs.

Manpower situation of the ANVS

The major part of RB staff is employed at the ANVS. The ANVS operates a regular planning and control cycle. In this cycle, the tasks to be undertaken are planned, taking account of the staffing levels available, while priorities are set when and wherever necessary. Over the past few years, the staff of what is now the ANVS, has been extended by 20 FTE. At present, the ANVS has a staff of about 120 fte. At the ministries of SZW and VWS another 4 fte is available.

During the IRRS mission of November 2014, IAEA recommended to assess the sufficiency of the staffing levels of the regulatory body. During the parliamentary debate on the legal establishment of the ANVS in 2016, the Minister of Infrastructure and the Environment agreed to have the manpower situation studied and report the results to Parliament. In 2016 the tasks and costs of the ANVS will be evaluated, including its required staffing level. During the peer review session of the CNS in 2017 probably more information can be provided on this topic.

The ANVS has contracted German TSO GRS for technical support in the area of supervision, for the development of regulations and guidelines and for the review and

assessment of the PALLAS-project. Furthermore ANVS works with Dutch consultancy firm NRG for support like studies on various topics, ad hoc Questions & Answers and aiding the drafting of national reports.

8.1.g **Financial resources**

From 2015 ANVS started with a dedicated budget within the national budget. The starting point of its budget was the sum of the budgets of the merged entities. The budget is awarded by the Minister of I&M and totals € 27 million. The spending budget of the ANVS for contracted support is currently about € 4M, mostly used for the TSO-work. In 2016 the budget was increased by about 0,5M€, partly on a temporary basis.

The resources at the RB currently are adequate, in terms of Human Resources (number of staff and expertise) and financing.

8.1.h **Quality management system of the RB**

Since the merger of the former separate entities of the RB in 2015, the new management system of ANVS is under development. Recommendations from the IRRS mission will be incorporated in the new system.

8.1.i **Openness and transparency of regulatory activities**

Both the creation of the ANVS and its future legal task to provide public information led to the recruitment of ANVS communication staff, which is currently a group of 3 fte, and growing. This is a positive development and will aid the ANVS in meeting its objectives for openness and transparency. Legal requirements on transparency by the ANVS comes from several international sources (e.g. the EU-directives on Nuclear Safety, Management of radioactive waste and Spent Fuel and the BSS).

The ANVS has its own website www.anvs.nl. This is also instrumental in positioning the ANVS as an independent authority and communicating with relevant stakeholders. In 2015 and 2016 the basic communication tools (website, intranet et cetera) have been and are developed further and improved. Relations with national, regional and local stakeholders and press are gradually built. Special arrangements are now underway for the communication and reporting of incidents in neighbouring countries.

Parliament is actively informed by the Minister of Infrastructure and the Environment, supported by the ANVS when relevant. Examples are results of IAEA mission reports, National Reports for the CNS, National Reports of Actionplans related tot the stresses et cetera. Every September the Minister sends an annual letter to the parliament with a general update on all important issues. In the future ANVS will have to report about its annual plan and the status of planned actions. ANVS will also have to report about its functioning as organisation (first evaluation in 2018 and then every five years).

Currently the following regulatory information and products are published on a regular basis, mostly on the ANVS website (examples):

- ANVS licenses
- ANVS regulations
- Several review and assessment reports (PSR, license application)
- Information about cross inspections with FANC (not the reports)
- Eventreports and followup
- General information about ANVS tasks and activities
- IAEA mission reports

Stakeholder involvement is embedded by public consultation during the licencing process and in the process of the Environmental Impact Assessment (EIA) under the

Environmental Protection Act. This process also involves meetings of ANVS, LH and the public.

In the external communication strategy of the ANVS in the future several developments are envisaged, among others:

- More active participations in the international public communication and transparency groups, e.g. ENSREG WGTA and OECD/NEA/WGPC.

8.1.j Publication of (summaries) of inspection reports. Future and current challenges for the Regulatory Body

Anticipated workload 2016 - 2018

Current challenges (2016-2018) for the ANVS in the areas covered by the CNS include a lot of parallel activities that need to be accomplished like:

- Implementation of updated EU-directive Nuclear Safety (2016-2017)
- Implementation of WENRA RL version 2014 (2016-2017)
- Supervision of implementation of stress test and PSR measures in several nuclear installations (2016-2017)
- Report and peer review of the Convention on Nuclear Safety (2016-2017)
- Topical Peer Review on Ageing management for one NPP and two RRs (2017-2018)
- Pre-licensing and licensing of new RR PALLAS (2016-2018)
- Upgrade project of existing RR HOR (2016-2018)
- Preparation for and having the IRRS follow-up (2017-2018)
- ANVS evaluation to present to the Parliament (2018)
- Several IAEA safety (follow-up) missions planned in 2016-2018

Furthermore, the financial position of LHs EPZ (Borssele NPP) and NRG (HFR Petten) are closely monitored, more details are given below.

Coping with the anticipated workload

Particularly the years 2017 and 2018 will be very busy. To cope with these challenges the TSO-support remains very important.

The present organisational structure of the ANVS (a department dedicated to nuclear safety, including a team dedicated to legal activities, a team dedicated to licensing and inspection of nuclear installations, supported by two expert teams to support these activities) will help organizing the work in an efficient way. The expert teams function as an internal "TSO", which in turn manage the contracts with the external TSO.

The IRRS Follow-up and the evaluation of ANVS in 2018 will be aligned/combined as far as possible.

Main future challenges

The main future challenge is the potential effects from the German phase-out. Germany will see the gradual closure of all NPPs until in 2022 the last German NPP will be taken out of service permanently. In 2013, on initiative by the ANVS the regulatory bodies from Germany, Spain, Switzerland and the Netherlands came together in the Hague to form an informal regulators group 'KWUREG'. Since then the group has had annual meetings in Spain (2014), Switzerland (2015) and Germany (2016). Meanwhile Brazil has joined this initiative. All participating countries will have Siemens/KWU reactors in operation quite some years beyond 2022. In the Netherlands both licensee and regulator have cooperated with German institutions and organisations. The goal of the KWUREG club is to monitor developments in Germany and look at needs and possibilities to maintain

support from German organisations and use experience that has been gathered during the past decades. It is necessary to cooperate to create alternative solutions.

On the agenda for the meeting in 2016 were:

- Developments at AREVA Germany (by AREVA)
- Available databases in German organisations like TÜVs, GRS
- Future support by GRS to KWU regulators
- Education and training of regulatory and licensee staff (KWU-design)
- Availability of spare parts
- Discussion about future exchange with Licensees

Financial issues regarding LHs

The past years have shown a fall in wholesale electricity prices, resulting in record lows. Conditions like limited economic growth and a greater role for subsidised renewable energy resources, may keep these prices EU-wide low for several years. These electricity market prices affect the profitability of the electricity production of the Borssele NPP. This poses a challenge to its owners (Delta 70%, and Essent 30%). At present scenario's are being developed to get better insight in the financial situation and possibilities. The ANVS is closely monitoring developments, as far as they may be relevant with regard to nuclear safety. More details can be found in the section on Article 11 'Financial and Human Resources'.

NRG, LH of the HFR in Petten, is managing the legacy waste project of the Energy Research Center ECN in Petten. This legacy waste (owned by ECN) needs to be repacked in a costly process and transported to the national waste management organisation COVRA. NRG is also involved in refurbishing its nuclear facilities. In addition there are discussions on EU level to achieve full cost recovery for the medical isotope production at reactors like the HFR. ECN faces some challenges regarding changes in the financing of its research. It should be noted that ECN holds 100% of the shares of company NRG. A decision on unbundling of the nuclear and non-nuclear activities of ECN is expected before the end of 2016.

Developments at abovementioned LHs are closely monitored by the ANVS as far as they may be relevant with regard to nuclear safety.

8.1.k External Technical Support

The ANVS can rely on various national and foreign organisations that regularly provide technical support. In this section the most important of these are introduced. The ANVS will continue to cooperate with foreign Technical Support Organisations (TSOs) for evaluating safety cases of Dutch LHs.

Governmental supporting organisation RIVM

The National Institute for Public Health and the Environment (RIVM) is a specialised Dutch government agency. Its remit is to modernise, gather, generate and integrate knowledge and make it usable in the public domain. By performing these tasks RIVM contributes to promoting the health of the population and the environment by providing protection against health risks and environmental damage.

The RIVM among others coordinates the back-office of the National Nuclear Assessment Team for radiological analyses and information (BORI). The RIVM supports the Ministries with scientific studies. RIVM works together with other (governmental) expert organisations as the Royal National Meteorological Institute (KNMI) with models for the prediction of the effects of discharges of radioactive material in the air. RIVM also operates the national radiological monitoring network.

Education and training organisations

The RID/R3 organisation at the Technical University in Delft and the Nuclear Research & consultancy Group (NRG) in Petten and Arnhem provide education and training in nuclear technology and radiation protection to clients from nuclear and non-nuclear businesses and various governmental organisations. For the education in the area of Radiological Protection, the ANVS also contracts various other universities.

Dedicated trainings on various topics are also contracted by the ANVS with other national and foreign supporting organisations.

For the education and training in radiation protection a national system exists with four levels of education. The government recognizes training institutes for a specific training of radiation protection. For getting a degree in radiation protection, an exam has to be passed.

Registration of radiation protection experts of the levels 2 and 3 is being implemented. There are formal requirements to obtain registration certificates for the initial education, for continuing education and for work experience.

Technical Support Organisations (TSO)

To date there is no national dedicated TSO. Organisations are contracted on Ad Hoc basis to support the RB with various tasks. Support is provided by foreign TSOs and national and international consultancy organisations. Some major supporting organisations are listed below.

GRS, Germany

The ANVS cooperates with a Technical Support Organization (TSO) from Germany, GRS. This is a TSO for the German national regulator and one of the large German TSOs. In the Netherlands it evaluates safety cases and provides other types of consultancy to the ANVS. In addition GRS provides associated education and training for governmental and commercial organisations.

GRS currently has a major framework contract with the ANVS.

NRG, Netherlands

The Nuclear Research & consultancy Group (NRG) in Petten and Arnhem provides consultancy & educational services to government and industry. The company has implemented 'Chinese Wall' procedures to protect the interests of its various clients and avoid conflicts of interest. NRG currently has a framework contract with the ANVS.

8.1.1 Advisory Committees

To date there is no standing advisory committee on nuclear safety; an advisory committee (the Reactor Safety Commission) is formed on an ad hoc basis as required. However the ANVS at any time can install a Commission dedicated to any required issue.

With a licence application, under certain conditions it is compulsory to conduct an Environmental Impact Assessment or EIA (Dutch: milieu-effectrapportage, m.e.r.). The Netherlands has a permanent institute, the Commission for the Environmental Assessment ('Commissie voor de m.e.r.', Cmer) that can be asked to advise on the requirements of all EIAs conducted in the Netherlands, including those related to nuclear facilities.

8.2 Status of the Regulatory Body

8.2.a Governmental structure

As described in section 8.1.a, the major part of RB staff is employed by the ANVS while there are other entities within the ministries of SZW and VWS contributing to legislative activities and the supervision of the activities of LHs. The entities are mentioned in section 8.1.b 'Entities of the RB'. The various entities have regular meetings on those activities for which they share responsibilities.

Also described in Summary, the ANVS will become an independent administrative authority (Dutch acronym: ZBO). It is expected that in 2017, the ANVS will have this status of a 'ZBO'. The ANVS currently is a directorate of the Ministry of Infrastructure and the Environment, and has been mandated to perform tasks on behalf of the Minister, currently the competent regulatory authority.

The ministry of I&M employs liaison officers that are the points of contact of the ministry in communication with the ANVS. The liaison officers are knowledgeable of the various dossiers of the RB and monitor developments as far as these are relevant for the Minister.

The ANVS cooperates with the Dutch Inspectorate, the Human Environment and Transport Inspectorate (ILT) of the ministry of I&M, in the monitoring of transports of radioactive materials to verify compliance with applicable regulations. The ANVS focus on the safety, radiation protection and security aspects, while the ILT focus on the requirements of modal transport regulations. A covenant on cooperation between ANVS and ILT is elaborated at the moment.

The ANVS for the documentation of its inspections, uses the ICT system 'HOLMES', which is a service provided by the ILT.

8.2.b Future development of the Regulatory Body

As noted above, the ANVS employs the main part of RB staff. The ANVS is expected to become in January 2017, an independent administrative authority, with its own legal authorities. The Minister of I&M in that situation will bear Ministerial responsibility for the ANVS.

Some growth of the ANVS might be necessary, assessments regarding the future needs of the RB are underway. Also refer to section 8.1.f.

8.2.c Reporting obligations

The ANVS reports to the Minister of I&M. The minister of I&M as competent regulatory authority reports to Parliament on nuclear safety, radiation protection, management of radioactive waste and other issues subject to the Nuclear Energy Act.

Results of major studies, conducted under the authority of the ANVS are presented by the Minister of I&M to Parliament. In addition, Parliament can and will now and then require the Minister to report to Parliament on specific issues in which MPs may have expressed an interest.

The ANVS has extensive files on many issues published on its website, featuring many in-depth studies on issues related to nuclear-related activities. Information on all major LHs can be found online too. This is part of the policy on transparent governance.

8.2.d Separation of protection and promotion

The ANVS is not in any way involved in energy policies. Its involvement with nuclear power is restricted to nuclear safety and radiation protection and associate issues. Development of energy policies is carried out by the Minister of Economic Affairs.

ARTICLE 9. RESPONSIBILITY OF THE LICENCE HOLDER

9. Each Contracting Party shall ensure that prime responsibility for the safety of a nuclear installation rests with the holder of the relevant licence and shall take the appropriate steps to ensure that each such Licence Holder meets its responsibility.

Regulatory basis

The responsibility of the Licence Holder (LH) emerges from the principles of the Dutch legal system, including the Nuclear Energy Act and underlying regulations, and the obligations referred to therein for the licence holder. The principle that the ultimate responsibility for safety lies with the Licence Holder (LH) is established in the legislation at several levels. This is explained further below.

Since 2011, as mentioned already in the text on Article 7, the Netherlands has transposed Directive 2009/71/EURATOM of 25 June 2009, establishing a Community framework for the nuclear safety of nuclear installations. One of the articles of the Directive states that the prime responsibility lies with the LH. This includes the requirement to develop a institutional safety policy at the corporate level and pursue continuous improvement. In the new Regulation transposing Directive 2014/87/Euratom of 8 July 2014 it will be further stipulated that the responsibility cannot be delegated and includes responsibility for the activities of contractors and sub-contractors whose activities might affect the nuclear safety of a nuclear installation.

Nuclear Energy Act

The Nuclear Energy Act contains a number of articles relating to criteria, interests and circumstances that must be complied with in order to be able to grant a licence. Article 70 of the Nuclear Energy Act specifies that a licence issued according to this Act is personal. In case of a license transfer this regulation requires that the new license holder needs to have the necessary expertise and reliability in relation to safety. Reliability in relation to safety can also be related to financial solvency.

The responsibilities accompanying a licence can only be transferred to another person with permission from the responsible Minister (in the future the ANVS will be the responsible authority). Conditions may be imposed on the transfer of the licence to a third party. This enables the Minister to assess whether the potential new licence holder meets the same standards as the previous licence holder.

The Nuclear Energy Act prescribes that the LH must produce a safety case for a new NPP or a substantial modification of an existing NPP to support its application for a licence. The Minister (and in the future the ANVS) shall assess this safety case and can only refuse to grant the licence in case this safety case does not satisfy the (legal) requirements.

Governmental Decrees

A further elaboration can also be found in the Radiation Protection Decree (Bs), as in Article 5, in which the licence holder is required to keep exposure of the population as a result of its activities as low as reasonably achievable. There are many regulations in the Bs that specify "*The operator ensures that*". The Bs also includes requirements in respect of the competence of the operator or LH.

Licence conditions

The licences contain conditions that require the LH to regularly evaluate the nuclear safety and radiation protection, and to report on those issues to the ANVS. Nuclear installations must have an adequate management system among others describing verification procedures. There is also a Nuclear Safety Rule NVR GS-R-3 which formulates these requirements in general terms.

In the licence of Borssele NPP, as a licence condition the NVR NS-R-2, a Dutch application of the IAEA document is applicable. Several articles in this NVR deal with the responsibilities of the operating organisation with respect to safety.

The licence also states that the LH must review the safety of the plant at both two-yearly and 10-yearly intervals (Periodic Safety Reviews, PSRs). These PSRs are subject to regulatory review. Safety evaluations are described in more detail in sections on other articles of the Convention. Refer to the section on Article 10 of the Convention for further details.

The LH's own Management System and internal verification organisation are important mechanisms enabling the LH to adhere to the licence and achieve its corporate safety objectives.

NVR-GS-R3 (Management Systems) referenced in the licence stipulates that the responsible organisation (i.e. the LH in most cases) shall retain the overall responsibility if work is delegated to other organisations.

Other obligations

With the Covenant of 2006, the LH of the Borssele NPP has agreed to ensure that Borssele nuclear power plant continues to be among the twenty-five percent safest water-cooled and water-moderated power reactors in the European Union, the United States of America and Canada.

The EU-directive on nuclear safety further dictates the LH's responsibility for nuclear safety and the obligation for continuous improvement of safety.

Monitoring and enforcement of compliance

Compliance with the licence and its terms is monitored by the ANVS by means of an appropriate supervision programme, including international safety missions, as already discussed in the section on Article 7. Periodic safety missions are carried out at the request of EPZ (such as WANO Peer Reviews and Technical Support Missions). In preparation of the mission, often the LH conducts a self assessment. The ANVS has always access to the results. Every ten years an OSART mission will be invited. In response to the IAEA actionplan post-Fukushima, it was decided to invite an OSART mission within three years. The mission visited the NPP in September 2014, one year before the originally planned date. Two modules were added on top of the standard mission: Corporate OSART and Independent Safety Culture Assessment.

An example of enforcement of compliance is the HFR-case, where a leakage of the primary circuit to the pool made clear that there is room for improvement of the present ageing inspection programme. The ANVS requested the LH to restore the safety boundary in a proper way before it would be allowed to restart the reactor and investigate if there are other places where the inspection effort might need to be enhanced.

EPZ activities and developments in communication and transparency to the public

EPZ has adapted its communication policy towards public communication developed specifically for the general public. EPZ fully recognises its obligation to communicate openly about the company and its plants to the general public with factual, reliable and understandable information. Its communication has been being changed from 'sender oriented' to 'receiver oriented'. The new Regulation transposing Directive 2014/87/Euratom of 8 July 2014 will also include requirements about transparent communication to the public.

Examples include all (post-)Fukushima communication, such as the EU-'stress test', and the publication of all formal event notifications to the regulator.

Its prime means of communication is its web site, but press conferences and interviews are used as well.

CHAPTER 2(C) GENERAL SAFETY CONSIDERATIONS

ARTICLE 10. PRIORITY TO SAFETY

10. Each Contracting Party shall take the appropriate steps to ensure that all organisations engaged in activities directly related to nuclear installations shall establish policies that give due priority to nuclear safety.

10.1 Policy on nuclear safety

10.1.a Regulatory requirements and implementation

The whole process of the design, construction, operation and decommissioning of a nuclear power plant in the Netherlands (as well as the licensing of all these stages) is characterised by a high priority given to safety at all stages. This is laid down in the Nuclear Energy Act, which requires (Art. 15c) that licence conditions shall be put in place in order to provide for the best possible protection against any remaining adverse consequences of operating a nuclear facility, unless this cannot be reasonably required. In the licence, a requirement is to comply with the Safety Requirements for nuclear power plant operation, NVR NS-R-2 (Safety of NPPs: Operation). This document requires that the operating organisation must be aware of the special emphasis that needs to be placed on safety when operating nuclear power plants. This special emphasis and commitment to safety must be reflected in the organisational structure.

NVR-NS-R-2 also states that plant management has a direct responsibility for the safe operation of the plant. All safety-relevant management functions, such as decisions on financial, material and manpower resources and operating functions, must be performed and supported at the most senior level of management.

NVR GS-R-3 requires the Licence Holder (LH) to establish a management system where priority to safety is paramount.

10.1.b Licence Holder's (EPZ's) policy and organisation

The policy plan of the Borssele utility is worth quoting in this context. It describes the priority attached to safety in relation to that given to financial considerations as follows:

The prime objective of EPZ is the production of electricity in a cost effective way, but the environmental risk involved in nuclear generation demands that the highest priority be given to nuclear safety (overriding priority).

In addition, the following policy statement can be found in the objectives of the Management System of the Borssele NPP:

Operation consists of a safety function, i.e. maintaining and improving operational and nuclear safety, and an economic function, i.e. producing electricity. The economic function will only be fulfilled if the nuclear power plant is safe, from a process and technical viewpoint, and if the safety function is being fulfilled in an adequate manner. The 'conditions for operation' and the 'limits' as laid down in the Technical Specifications must be observed at all times.

Currently the plant's top management is being reorganised, which will result in the following arrangement. The Plant Manager (PM) is responsible for the economic function; economic production in accordance with licence and with nuclear safety as overriding priority. He bears full responsibility for nuclear safety and radiation protection. The PM has power of enforcement should nuclear safety or radiation protection be challenged.

The internal nuclear safety advisory board (RBVC) advises the PM on nuclear safety and radiation protection issues. The PM reports directly to the CEO. This ensures that safety is given a proper role in this economically oriented environment.

EPZ has several independent bodies to support top management with respect to (nuclear) safety, radiation protection and (radiological) environmental issues. The most important are:

ALARA Committee	Its function is to advise the RP manager on Radiation Protection issues.
RBVC	(Internal Nuclear Safety Committee). Its function is to advise the PM on nuclear safety and RP-issues.
ERBVC	Its function is to advise the CEO on organisational issues, in particular by evaluation of the nuclear safety performance of the plant and the performance of the RBVC.
NV&KZ ⁶⁴	Nuclear Safety & Quality Assurance department. This is a dedicated department for independent supervision on nuclear safety, radiation protection and quality assurance. Its manager reports directly to the CEO of the company.

Where new safety insights emerge, their relevance to the NPP is scrutinised and modifications are initiated if they are found to offer sufficient safety benefits to justify their cost. Although there is no formal requirement in the Netherlands to carry out a cost-benefit analysis, practical experience (such as the major back-fitting programme at Borssele) has shown that the modifications have comfortably met the criteria applied in other countries. EPZ has documented itself a cost-benefit procedure, where amongst other things a certain monetary value is related to the improvement of the core damage frequency.

As already mentioned, regular safety improvements have to be performed. At two-yearly intervals the operation of the plant must be evaluated against the existing licence requirements and at 10-yearly intervals a thorough safety evaluation against modern safety requirements and current safety insights on technical, organizational, personnel and administrative aspects. These Periodic Safety Reviews (PSRs) and the resulting improvement or modification projects are aimed solely at further improvement of plant safety.

The LH (EPZ) of the Borssele plant is a member of WANO. The CEO of EPZ is member of the board of WANO Paris centre. Further EPZ is member of the PWR Owners Group and the German VGB, which provide a valuable source of information. Staff takes an active part in international WANO and IAEA missions.

10.1.c **Supervision of priority to safety**

Supervision is one of the tasks of the Regulatory Body (RB). The ANVS uses the following

⁶⁴ NV&KZ, Dutch: 'Nucleaire Veiligheid & Kwaliteits Zorg'.

general approaches.

First the ANVS pays attention to developments regarding the NPP with respect to the annual plan, management, nuclear leadership and position of shareholders to make sure that safety is properly prioritized.

Secondly the ANVS pays attention to subjects and events the NPP organisation declares as purely economical. The ANVS assesses the assumption of the NPP that safety aspects play no role in the subjects or events concerned.

Finally the ANVS continues to emphasize the importance of periodic safety reviews (PSRs) and continuous improvement.

Until recently ANVS had limited knowledge in financial matters. Due to the increased amount of work related to financial issues and nuclear safety (assessment of sufficient financial resources to implement safety requirements etc.) one FTE with specific financial expertise will be added to the ANVS staff.

Further some more detailed examples of the practice of supervision are:

- Justifications of continued operation and their evaluation by the ANVS.
- Temporary modifications and their evaluation by the ANVS.
- Issues of gradual degradation, although the safety requirements keep being met. In these cases the ANVS will urge the LH to act and restore the original situation.

The global description of the NPP organisation, including specifications of competences and authorities for key staff, is part of the Technical Specifications. On top of that there is a licence condition to submit a safety case for organisational changes with safety relevance and it is therefore subject to regulatory review and inspection.

The ANVS's policy and ambition is to closely follow international safety developments by participating in several international committees. The information is amongst others used to evaluate the safety insights and improvements that the NPP organisation is proposing.

As an illustration of the high priority given to safety, it is worth mentioning that the Netherlands participates actively in the Incident Reporting System and has bilateral contracts with Belgium and Germany with regard to the evaluation of incidents.

10.2 Safety culture

10.2.a Requirements

Basic requirements are adopted from NVR-GS-R-3, referenced in the licence of Borssele NPP.

10.2.b Safety culture at Borssele NPP

The staff of the Borssele NPP is fully aware of the necessity of having safe working conditions and practices to avoid any harm to humans, installation or environment. The policy is to execute no activity until it is ensured that it can be done safely. Integrated risk analysis, procedures, instructions, checklists, training programs, etc. have been developed to ensure that important safety considerations are not forgotten or overlooked when planning and carrying out the work. Pre-job briefings and last minute risk assessments are used as last safety barriers and independent safety inspectors are employed for monitoring and oversight.

Safety performance is monitored and evaluated by LH to discover underlying causes and trends. In addition independent safety assessments, like reviews by safety specialist from

peer companies, are used to identify areas for improvement. Also WANO peer reviews contribute to further improvement as WANO measures performance against best practices in industry. Most important areas for improvement which were identified during last (peer) reviews and which will help LH to close the gap to excellence are: leadership, performance measurement and operating experience. Action plans are being developed and implemented by LH. Focus will be on the reinforcement of management expectations, strengthening ownership and a restructure of the management system to improve the continuous improvement cycle.

Recent independent 'progress measurement' were the WANO follow-up review in 2014, the Independent Safety Culture Assessment module combined with the OSART mission in September 2014 and the WANO Peer Review in 2016.

10.2.c Supervision of safety culture.

Although no formal criteria have been developed to measure 'safety culture', the inspections performed by the ANVS include monitoring the LH's attitude to safety. For several years the ANVS used the so-called KOMFORT method to monitor safety culture, a method developed in Germany. The ANVS has integrated safety culture in the supervision program using IAEA guidance, although this still has to be formalized.

Due to organization changes within the ANVS there was in 2015 no (yearly) meeting of with the LH about achievements and development of safety culture and human performance. The aim is to organise this meeting again in 2016 and the meeting scope will also cover organisational issues.

Safety culture is also a subject of the OSART missions initiated by the ANVS as mentioned in par. 10.2.b. More details on the safety culture at the Borssele NPP are given in Appendix 3.

In the past there have been safety culture problems at the HFR in Petten, that were remedied by the LH, NRG, with a dedicated program. In order to verify the achievements of the program, in the second half of 2008, the ANVS conducted a safety culture audit, using the IAEA-SCART guideline. The main conclusion was that still improvements were possible. NRG was advised not to reduce efforts in this area, to prevent jeopardizing the achievements. In 2012 the ANVS carried out a followup audit with the following conclusions:

Improvements have been made since 2008 however more attention has to be given to a more systematic approach of safety culture, external assessment of safety culture and a more consistent approach of safety culture on corporate level.

To monitor the improvements in this area there will be an INSARR mission in October 2016, which also contains a safety culture module. Begin 2017 an IAEA-ISCA will be conducted at NRG.

Appendix 7 contains more information about the HFR and – among others – the safety culture improvements.

10.3 Management of safety (including monitoring and self-assessment)

10.3.a Requirements

Main requirements are recorded in NVR-GS-R3; this NVR is referenced in the licence.

10.3.b Self-assessment by LH (EPZ of Borssele NPP)

Organisational aspects have been described in para 10.1.b.

Self-monitoring is mostly based on performance indicators. The LH feels that the use of performance indicators could be enhanced and expanded. This need is supported by the self-assessments and the WANO Peer Review.

Relevant self-assessments include:

- Yearly evaluations and reporting on plant functions, such as operational experience feedback, surveillance and in-service-inspections, ageing management, RP, radiological releases, and radwaste. (some of them are a licence condition)
- Two-yearly evaluation of the current licensing basis.
- Ten-yearly periodic safety reviews.
- NV&KZ (department for independent supervision) inspection and audit programme.

Independent safety assessments invited by the plant include WANO Peer Reviews and WANO Technical Support Missions. The regulator invites the IAEA, for OSART, SALTO, IPPAS, and IPSART missions.

Currently EPZ is in the process of restructuring the integral management system based on the NVR-GS-R-3 requirements.

10.3.c Supervision of safety management (including monitoring and self-assessment)

The assessment of the safety management system of the License Holder is part of the ANVS' surveillance program. ANVS pays attention to effectiveness of the safety management system during the assessment of changes of the organisation and/or procedures and during incident analyses. Further reference is made to article 13.

10.4 Safety culture at the Regulatory Body

A strong safety culture at the License Holder is an important topic in the oversight exercised by the Regulatory Body (RB). Within the RB safety culture is build up by several parts implicitly, e.g. the application of the four eyes principle.

Because the ANVS is a relative new organization it takes a lot of effort to organise the work (procedures and approaches) and people. Apart from this work on the structure of the organisation, the importance of an effective safety culture within the RB is now secured as a policy statement in the main organisational document of the ANVS. Meanwhile there are some initiatives to improve internal cooperation, attitude and communication. A major initiative was a course held last spring for all staff working on nuclear safety. Based on the work of organisation Argyris, staff discussed and was trained in three sessions about teaching smart people how to learn from each other.

ARTICLE 11. FINANCIAL AND HUMAN RESOURCES

11.1 Each Contracting Party shall take the appropriate steps to ensure that adequate financial resources are available to support the safety of each nuclear installation throughout its life.

11.2 Each Contracting Party shall take the appropriate steps to ensure that sufficient numbers of qualified staff with appropriate education, training and retraining are available for all safety related activities in or for each nuclear installation, throughout its life.

11.1 Adequate financial resources

11.1.a Economic background

BORSSELE NPP

In the last decades operators of electric power generating have had to cope with political and social changes as well as new economical and technological factors. Examples of these changes and factors are electricity market liberalisation, changing oil and gas prices, changing wholesale prices, very low interest rates, growth of production from renewable sources and extraordinary ICT development.

Liberalisation

The European electricity market has undergone major changes. Prompted by EU legislation, the EU member states have restructured their electricity sector to allow for more competition. A well-functioning competitive European electricity market should deliver on access to competitive electricity prices, on security of supply and ensuring investments. Due to liberalization of the electricity market, several competing operators have been created and the market is still changing. As a result of these developments the electricity sector has seen the formation of alliances and mergers. The past five years have shown a fall in wholesale prices, resulting in record lows. Conditions like limited economic growth and a greater role for subsidized renewable energy resources, may keep these prices EU-wide low for several years.

The price drop has major consequences for all power providers; it is obvious that in all EU countries including the Netherlands, the European electricity market has introduced new dynamics with an increase in the interest in commercial and economical aspects. Therefore regulatory attention to the relationship between production, financials aspects and safety is continuously required.

Unbundling

In the past, the electricity markets were almost completely controlled by the electricity companies with large, vertically integrated utilities that used to be regulated by state monopolies. These companies typically owned almost all generators, as well as transmission and/or the distribution network. The EU's executive body has been a strong advocate of unbundling generation and network activities to prevent these companies from using their influence to reduce competition. Several EU countries are opposed to full unbundling. As a compromise, European states are free to choose from several options to promote competition. In the Netherlands, unbundling has almost been completed.

Tolling agreement

EPZ has a tolling agreement with its shareholders to cover the cost of electricity production, including investments and funding for decommissioning. The abovementioned development in electricity market prices affect the profitability of the electricity production of the Borssele NPP and this poses a large challenge to its owners (Delta and Essent). The future of Delta, and indirectly of EPZ, is currently on the political agenda. The ANVS is closely monitoring developments, as far as they may be relevant with regard to nuclear safety.

COVRA

Funding for the long-term operation of HABOG and the final disposal is on the political agenda as well.

11.1.b Legislative aspects of responsibility and ownership

The principle that the ultimate responsibility for safety lies with the Licence Holder (LH) is laid down in several layers of regulation. More about this can be found in the text on Article 9.

The Nuclear Energy Act contains a number of articles, which deal with criteria, interests and conditions under which a licence can be awarded. The explanatory memorandum on Article 70, which states that a licence is to be awarded to a corporate body, refers to guarantees of necessary expertise and trustworthiness in relation to safety. Trustworthiness in relation to safety can amongst other things also be associated with financial solvability.

The licence does not automatically pass to the LH's successor in title. In the case where major changes in ownership of EPZ (LH of the Borssele NPP) are planned, the LH is obligated to inform the regulator three months in advance. Article 70 of the Nuclear Energy Act stipulates that any transfer of ownership must take place with the consent of the responsible Minister. This allows the Minister to assess whether a potential new LH can meet the same standards as the previous one. A licence to a potential new LH will be refused if a change in ownership alters certain circumstances that are of vital importance from a licensing point of view, including adequacy of financial provisions.

LH EPZ (owner of Borssele NPP) is a private company with two shareholders. Changes in shareholders and a transfer of shares between them have resulted in a majority shareholder (public company, with 70 %) and a minority shareholder (private company, with 30%). The changes in shareholders have led to the conclusion of an agreement between the shareholders and the Dutch government on public interests concerning the (shares in) the nuclear power plant ("convenant publieke belangen kerncentrale Borssele"). The agreement, among others, concerns safeguards on public interests when operating the power plant and sets criteria and procedures to follow should a shareholder wish to transfer (part of) its shares.

11.1.c Rules and regulations on adequate financial resources for safe operation

Based on the EU-Directive on Nuclear Safety a requirement of adequate financial resources is included in the Dutch regulations.

Also the the licence of Borssele NPP refers to NVR NS-R-3, NVR NS-G-3.1 and NVR NS-G-3.2 . The license does not contains direct requirements to have adequate financial resources but, in order to ensure the safe operation of the NPP, it does require the LH to cope with the costs for safe operation. For instance, it stipulates that the management of an NPP must act promptly to provide adequate facilities and services during operation

and in response to emergencies. The personnel involved in reviewing activities have to have sufficient independence from cost and scheduling considerations. This applies to reviews of all safety-related activities.

The requirement to provide these services and facilities implies the requirement to provide the necessary financial resources for them.

11.1.d Financing of safety improvements at Borssele NPP

A major policy principle of the LH is the overriding priority of nuclear safety. This includes that LH's management will act promptly to provide adequate facilities and services during normal operation and in response to emergencies.

The LH's policy is part of the EPZ corporate plan. The corporate plan comprises a period of three years and is drawn up every year. They are presented to the corporate shareholders for approval. One of the main programmes in the corporate plans is the continuous enhancement of the nuclear safety on the power plant. From the corporate plan every year there will be written an annual plan for implementing the programmes.

Before those annual plans will go to the shareholders, they have undergone an internal budgeting process to finance the programmes for that year. During that budgeting process the Quality Assurance Department will see to it that the budgeting process does not have negative consequences for nuclear safety.

According to the licence the LH has to do a periodic safety review every two years (against the current licence conditions) and a more thorough safety evaluation (against the state of the art) every ten years. In the 10 yearly evaluations, the evaluation points will be assigned with safety significance on basis of:

- A deterministic approach described in the NVRs and IAEA Safety Standards;
- A probabilistic approach (PSA) with emphasis on the significance for the core damage frequency and individual risks;
- Considerations from the perspective of radiation protection for workers, the public and the environment;
- The defence-in-depth approach according to INSAG 10.

This evaluation will result in a list of possible actions to improve the safety. On a basis of cost-benefit considerations, it is decided which measures from that list will be implemented within a certain timeframe.

Because the operating life of the Borssele NPP is expected to be 60 years, a number of investments has been and will be made in the near future:

- Long Term Operation project, giving attention to among others ageing issues;
- Replacement of analog electronics by digital I&C for the rod control and limitations system (RCLS);
- Proactive replacement of a large number of components, the reliability of which may not be guaranteed until the new end date of operation;
- Complete overhaul of the Final Safety Analysis Report (FSAR) based on the Periodic Safety Review 10EVA13;
- Redesign of the organisation;
- Continuous striving for excellence;
- Fukushima lessons learned.

11.1.e Rules and regulations on financial resources for waste management activities

The Netherlands' policy on the management of radioactive waste and spent fuel is to isolate, control, and monitor radioactive waste in above ground structures for an interim period of at least a hundred years, after which geological disposal is foreseen. During the

period of interim storage all necessary technical, economical, and social arrangements are to be made in such a way that geological disposal can be implemented after the period of above-ground storage.

Implementation of this policy led to the establishment of COVRA, the Central Organisation for Radioactive Waste, located in Borsele. COVRA is a 100% state owned organisation, and is the only organisation allowed to manage and store the radioactive waste and spent fuel. Upon transfer to COVRA, COVRA takes over all liabilities, including the responsibility for final disposal.

According to the generally applied 'polluter pays' principle, the generator of the waste is charged for all costs related to the management of radioactive waste and spent fuel, including the envisaged costs for final disposal. Once the transfer of the waste has been accomplished, the customer is exempted from further responsibility for the waste.

With regard to the management of Spent Fuel (SF) and High Level Waste (HLW), the owners of the NPPs of Borssele and Dodewaard (the utilities) and the operators of research reactors (RRs) agreed to jointly build a facility for treatment and long-term storage of Spent Fuel (SF) and High Level Waste (HLW) at the COVRA site. This building (HABOG) was commissioned in 2003 and is now receiving vitrified and other HLW from reprocessing plants as well as SF from the research reactors. Both the construction costs and the operating costs are borne by the generators of the SF and the high level waste.

In the frame of transfer of ownership of COVRA from the utilities and ECN (parent company of NRG) to the State, the utilities decided to discharge themselves from any further responsibility for management of the radioactive waste. They made a down payment to COVRA covering the discounted costs for operation and maintenance of the HABOG during the envisaged operational period (~100 years). The other customers of the HABOG pay their share of operational costs by annual instalments.

For Low and Intermediate Level Waste (LILW) there are fixed tariffs for specified categories of radioactive waste, which take into account all management costs. The tariffs are annually adjusted with the price index.

Financing a repository for final disposal

In the past the costs for the construction and operation of a repository for radioactive waste in salt formations in the deep underground have been estimated. In the cost study, it is envisaged that all radioactive waste, LILW and HLW, will be placed in this repository. The required sum was disbursed to COVRA in the framework of the transfer of ownership of COVRA to the State.

For LILW a separate procedure is followed: COVRA raises a surcharge for waste disposal on the fees of generators of radioactive waste. Out of the total amount of money estimated to be needed for the construction and operation of a disposal facility, one third has to be covered by the surcharge on LILW. The other part has to be covered by the HLW and SF.

For more information waste management issues, refer to our national report for the 'Joint Convention on the Safety of Management of Spent Fuel Management and on the Safe Management of Radioactive Waste Management'.

11.1.f Rules and regulations on financing decommissioning

According to legislation in force since April 2011, a nuclear facility shall be decommissioned directly after final shut down⁶⁵. Decommissioning implies the implementation of all administrative and technical measures that are necessary to remove the facility in a safe manner, and to create an end state of 'green field'. Therefore, the LH is required to develop a decommissioning plan, describing all the necessary measures to safely reach the end state of decommissioning, including the management of radioactive waste. This decommissioning plan shall be periodically updated, and shall be approved by the Regulatory Body.

The legislation also requires the LH to make available adequate financial resources for decommissioning at the moment that these are required. Therefore, the LH will have to calculate the costs of all the activities described in the decommissioning plan, and provide for a financial provision offering sufficient security that all costs are covered at the envisaged start of decommissioning. The LH is free to choose the form of the financial provision; however, it shall be approved by the authorities.

Also refer to the text on Article 7 of the Convention for the recent updates of the legislation.

11.1.g Statement regarding the adequacy of financial provision

Nuclear safety has overriding priority within the company. Shareholders are aware of the importance of high performing on nuclear safety. Costs for safety improvements are considered as an integrated part of the operation costs. A high safety level, demonstrated by a good safety record is considered as an essential component of the business concept.

EPZ annually invests 5-20 M€ of which 30%-60% safety related. Investments necessary for (improving) safe operation are not evaluated on a commercial or economical basis. From EPZ and its shareholders perspective safety related investments are a duty of a nuclear operator and a licence to operate instead of a possibility to decide on.

Up to now EPZ has been allotted enough financial resources for maintaining the appropriate level of nuclear safety by its shareholders. The price of a kWh of electricity produced in the EPZ NPP is set out by the management and approved by the shareholders (who are also the only customers), based on the yearly business plan. Such a price covers all gross operating expenses, i.e. electricity generation costs as well as necessary investments. Besides this, the shareholders annually approve the Long-term Investment Plan.

The adequacy of EPZ's financial system and internal controls is assessed by an external auditor. According to the safety and security charter, the management hereby is committed to provide all necessary financial means to enhance safety and to ensure all required security measures.

Currently, the financial provisions of EPZ seem adequate to fulfil its regulatory requirements. As long as the owners of EPZ provide the money needed according to the tolling agreements .

The 70% majority owner of EPZ is DELTA a company for 100% owned by the municipalities and the province. The other 30% is owned by RWE. As stated above

⁶⁵ The NPP Dodewaard, brought into a state of Safe Enclosure in 2005, is excluded from this requirement.

(paragraaf 11.1 a) the future of Delta and indirectly EPZ is uncertain and political decisions are expected soon.

11.1.h **Supervision of financial arrangements and provisions**

Until now, the sufficiency and adequacy of the budget of the LH for safety was only marginally checked by the ANVS. The subject is discussed during periodic management meetings and also in the case of larger investments (e.g. improvements from the periodic safety review).

In the case of decommissioning, the ANVS performs the assessment in cooperation with the Ministry of Finance.

One FTE with specific financial expertise will be added to the ANVS staff to allow for a more extended supervision on financial arrangements and provisions.

11.2 **Human resources**

11.2.a **Legislative aspects**

The Nuclear Energy Act stipulates that an application for a licence must contain an estimate of the total number of employees plus details of their tasks and responsibilities and, where applicable, their qualifications. This includes supervisory staff. In the last years the transposition of the EU-Directive on nuclear safety has reinforced the requirements on adequacy of human resources.

In the license of the Borssele NPP reference is made to NVR NS-G-2.8 (Dutch application of IAEA NS-G-2.8) and the specific Safety Guide NVR 3.2.1 for control licensed room personnel.

The safety relevant part of the organisational structure of the plant is described in the Technical Specifications, with clear details of the responsibilities, authority interfaces, lines of communication, requisite level of expertise, and the requirements for training and education. It is therefore part of the licence, and hence subject to inspection by the ANVS. Another part of the licence is that any planned organisational change with possible safety relevance, must on forehand be reported to the authorities.

Under NVR-NS-G-2.8 the responsibility for ensuring that individuals are appropriately qualified and remain so rests with the operating organisation. It is the responsibility of the plant manager, with reference to each position having importance to safety to ensure that:

- The appropriate qualification requirements are established;
- The training needs are analysed and an overall training programme is developed;
- The proficiency of the trainee at the various stages of the training is reviewed and verified;
- The effectiveness of the training is reviewed and verified;
- The competence acquired is not lost after the final qualification;
- The competence of the persons occupying each position is periodically checked and continuing training is provided on a regular basis.

The LH has to submit its education and training plan for its control room staff to the RB for information and approval.

In 2009 the NVR 3.2.1 for control room personnel has been changed with respect to the former 60-years limit of the age of control room staff. Now the qualification is based on performance.

11.2.b Training and qualification of EPZ staff

The Borssele NPP has a training department that is responsible for: maintaining the personnel qualification register, qualification activities, coordination of training activities, training records keeping, and delivering of in-house developed training courses; and organizing training courses that are delivered by contractors. For conduct of the in-house developed training, subject matter experts are extensively used. Training responsibilities for conduct of practical (on-the-job) training are distributed among respective plant departments.

Training and personal development programmes are developed based on competency analysis and consequent training matrix for each job position. Nuclear safety, ALARA principles, industrial safety, operating experience (domestic and international) are included and re-enforced during general employee training, during conduct of initial training programmes and during refresher courses. Training programmes are structured to cover required theoretical knowledge, practical training and on-the-job training. Training material for the basic course is under QA review scheme.

Control room operators, emergency support staff and several others use the full scope, plant specific training simulator. This simulator is based in the simulator school in Essen (Germany). Training is given by professional teachers of the simulator school.

The simulator dates from 1996. Recently, a 3-D core model has been integrated reflecting the actual reactor. Furthermore, emulator software is implemented for running the actual software of the digital RCLS that will be implemented in 2017.

Both the recent WANO Peer Review and the preliminary results from the PSR finished in 2013, show that both its scope and fidelity should be enhanced to meet the current state-of-the-art.

The contracted staff for running the simulator training programme is of appropriate size and comparable to general industry practice.

External organizations are extensively used for delivering training. For specialized training on specific equipment vendor facilities are used. For safety related subjects, equipment vendors or recognized institutions in the nuclear field are used, for example Westinghouse, AREVA, WANO, and NRG⁶⁶.

Training on emergency preparedness is conducted regularly. The plant has a dedicated desktop simulator for emergency exercises, including core melt scenarios for training on SAMGs. Individuals having the position of Site Emergency Director attend position specific training and once per year a simulator retraining course together with one shift team. Large scale emergency exercises are supported also by training on the full scope simulator. In relation to the Complementary Safety Assessment (CSA) or 'stress test', competence, availability and sufficiency of the staff required for severe accident management has been assessed, including contracted personnel or personnel from other nuclear installations. Several improvements have been introduced. Also training programmes have been improved as a result of among others new insights from the CSA, periodic safety reviews (PSR), operational experience, development of training methods and practices.

Additionally, every year on average five staff members of EPZ are involved in WANO, OSART, AMAT and other similar missions. Three EPZ-employees are seconded to the WANO Paris Centre.

⁶⁶ Nuclear Research and consultancy Group, Netherlands

Training facilities

A replica full scope simulator, located at the training centre KSG&GfS near Essen in Germany, is used for training of the Borssele plant personnel. The training is given in Dutch. The annual retraining programme for operations control room personnel is developed corresponding to a 5-year training plan. Learning objectives are developed based on competences and operational feedback (communication skills). Additional topics are added based on operations management inputs and feedback from trainees. Operators attend two weeks of on-site training where one part is on plant modification (just before outage) and the second part is on applicable portions of the annual refresher course. Both the training programme and the simulator need to be approved by the RB.

For shift team evaluation the plant developed a method for continuous evaluation based on 20 elements that are documented in each scenario exercise guide; results are followed for recognition of weak areas in performance and used for future attention.

The electrical and instrumentation training facility includes fully equipped classroom and separate rooms for practical (on-the-job) training. A high number of comprehensive mock-ups is available and most of them were developed in-house. Many mock-ups have capability to introduce malfunctions and are excellent tools for training on troubleshooting techniques.

The mechanical maintenance training facility, intended for on-the-job training is located inside the radiological controlled area. The inventory of mock-ups to train the most critical work sequences, especially from the ALARA standpoint, includes a steam generator bottom section, special valve types (disassembly/reassembly), part of reactor vessel and adjacent wall to train on replacement of rupture plate special seals. Construction of a loop flow simulator will be finished medio 2016.

Formal authorization before assigning certain persons

A formal authorization issued by the RB or by another body delegated or authorized by the competent authority is required before certain persons are assigned to a designated safety related position. According to NVR 3.2.1, control room operating personnel need to be in possession of a special licence. This is issued once the candidate has completed a specified period of training and passed an examination which is supervised by the RB. The licences are signed by the plant manager and co-signed by the director of the ANVS. All training, education, examinations and medical checks of licensed personnel are documented.

There are three levels of control room licences that require renewal every two years:

- reactor operator;
- senior reactor operator;
- shift supervisor;
- deputy shift supervisor.

There is no difference between the qualifications required for operators working on the nuclear side and those working on the turbine side, as the policy is that operators should be fully interchangeable.

Instructions to plant staff on management of accidents beyond the design basis

For the management of accidents beyond the design basis an emergency plan is implemented and agreed with the authorities. Instructions from the emergency procedures are applied. From these are initiated for example the symptom based procedures and the Severe Accident Management Guidelines (both originally from the Westinghouse Owner's Group). In addition the emergency staff in case of an incident can

use the software package WINREM which features a reliable model for the dispersion of radioactivity and the calculation of the potential consequences of accident releases.

Assessment method of qualification and training of contractor's personnel

At EPZ qualifications of the contractors depends on their job or area they have to work in. Independent to their job or area, all the contractors are qualified for industrial safety by the VCA qualification. This is a general Dutch qualification for working in the industry, like the international equivalent SCC⁶⁷. In addition to that, EPZ has two courses that are compulsory for all workers, whether they work in 'conventional' or 'nuclear' areas and that aid working safely at EPZ's plant. Besides that EPZ has a special qualification for work party leaders called Ziza. All the work party leaders and workers who work without supervision in the plant are specially qualified for this work. Qualifications of special craftsmen are part of the purchasing conditions and are controlled by the purchasing department.

11.2.c Assessment method of sufficiency of staff

The process of recruitment and selection of staff is managed so that it ensures enough qualified staff under all circumstances. Performing independent internal audits assesses this process.

11.2.d National supply of and demand for experts in nuclear science and technology

In the Netherlands, education in radiation protection, nuclear safety and nuclear technology is provided by several universities and other organisations. Education in nuclear technology at academic level is provided by the Delft University of Technology. Many companies applying nuclear technology provide in-company trainings.

At the moment there seems a balance between supply and demand. At times it may be difficult to find an expert with a certain number of years of relevant experience. But several companies also get qualified staff from abroad.

11.2.e Supervision of human resources

The surveillance program of the ANVS includes human resources. The LH's number of staff, their education, their training and their experience are being assessed. Safety relevant changes in organization and staff must be approved by ANVS.

⁶⁷ Safety Health and the Environment (SHE) Checklist Contractors

ARTICLE 12. HUMAN FACTORS

12. Each Contracting Party shall take the appropriate steps to ensure that the capabilities and limitations of human performance are taken into account throughout the life of a nuclear installation.

12.1 Introduction

Human Factors (HF) refer to all factors in the work environment as well as the human and individual characteristics that may have an impact on health and safety at the workplace. HFs can be classified into two categories: internal factors such as talent, competence, professional skills, motivation, stress resistance and situational flexibility, and external factors such as work environment, actual and potential process control, procedures, training and education, accessibility of components and automation. The emphasis in the design of man-machine interfaces is one of the external factors.

Although man-machine interfaces have always played a role in the design and operation of complex machinery such as NPPs and aircrafts, it is only in recent decades that they have become part of the evaluation and attention processes and as such are widely recognised. With the development and performance of PSAs, systematic data collection and structural modelling have become part of the process of evaluating Human Factors.

12.2 Legislative aspects of HF

Human Factors play an important role in nuclear safety. The Dutch rules and guidelines (NVRs) referenced in the licence of Borssele NPP – especially those related to the Management System and the operation – do take account of Human Factors, as do the original IAEA Safety Guides the NVRs are based on.

Since the NVRs are part of the licence, the LH is required to give full consideration to Human Factors.

12.3 Methods and programmes for human error

The evaluation method to be used when inspecting and assessing the influence of Human Factors on incidents needs to be based on a well-proven systematic approach. The method being used since 1992 by the Dutch LHs is the original American method known as the HPES (Human Performance Enhancement System).

To improve the results on human performance, the plant has started a Human Performance Program that covers the following subjects:

- Embed the organizational aspects of Human Performance in daily operations;
- Create, communicate and reinforce Management Expectations, including the use of Human Performance tools;
- Improve effectiveness of management in the field;
- Perform and improve Human Performance initial and refresher training courses;
- Development of a work practice simulator.

The Human Performance program was executed in the years 2013 and 2014.

The plant has dedicated modules on Human Factors in its initial and refresher training courses.

A loop flow simulator has been developed, and is under construction.

12.4 Self-assessment of managerial and organizational issues

Apart from the assessments of the impact of proposed operational or design changes on safety or the Periodic Safety Reviews (PSRs), which are both regulatory and institutionalised requirements, the LH regularly performs self-audits, or requests audits or peer reviews by others in order to evaluate its own operation. In particular the Organizational, Personnel and Administrative aspects of operation are subjects for these audits and peer-reviews. The licence requires two formal types of self-assessment, to be reported to the RB: the 2-yearly PSR and the 10-yearly PSR. The documentation of the PSRs is subject to regulatory review. For details on PSRs refer to the chapter on Article 14 'Assessment and Verification of Safety'.

Other examples of self assessment with consideration of HF are the WANO-Peer Reviews in 2012, 2014 (follow-up) and 2016. The 2012 SALTO mission had a part dedicated organizational aspects (relevant to LTO). At least every 4 years there will be a full scope WANO Peer Review at the NPP. An OSART mission was conducted in 2014. A WANO PR was conducted in 2016.

An important aspect in the assessment of safety is the ability of the assessor to make use of the state-of-the-art technologies and methodologies. Therefore, experts of the LH participate in audit and peer-review teams of IAEA and WANO to evaluate other plants. Participation in Technical Support Missions at other plants is encouraged. The insights gained from these participations are used in their assessment work at Borssele NPP.

At Borssele NPP, the internal safety review of technical and organisational modifications is organised as follows:

- *Technical*: All aspects of technical modifications relevant to safety are documented in a 'Modification Plan'. This report is verified by all relevant specialists. After their comments have been taken into account, the report is independently reviewed by staff in the Safety Design Department. Once accepted by this department, the original report and the independent review report are sent to the Internal Reactor Safety Committee to advise the Plant Manager for authorisation. The last step in the review is an assessment under the authority of the RB. In the case of minor modifications with no impact on safety, a simplified procedure is applied.
- *Organisational*: Proposals for safety relevant organisational modifications are prepared by the Human Resources Management Department. The final proposal is outlined in a report describing the changes relating to the organisation (structure, tasks/responsibilities, systems, documents, staffing and potential associated impact on nuclear safety). The (internal) independent nuclear safety officer checks the final proposal against all the organisational requirements laid down in the licence, NVRs (amended IAEA codes and guides) and other relevant regulatory documents and produces a report on his findings. The two reports (the final proposal and the independent verification) are then reviewed by the internal and external reactor safety committees of the Borssele NPP before being submitted to the authorities.

12.5 Human factors and organisational issues in incident analysis

At the Borssele NPP information on event reports and analysis results and near miss reports is accessible to all staff through the company intranet. The categories 'written procedures' and 'personnel work practices' are causing most human errors. Lessons learned or corrective actions from operating experience can lead to corrections or enhancements of the work instructions or the lessons learned from individual events or trend analysis can lead to a toolbox meeting e.g. to raise the awareness about the

human factor in events. For operations personnel, the feedback on operating experience is part of the yearly refresher training which is also attended by other people. Some statistical information derived from the annual report, lessons learned and important external events are on the agenda of that training.

In the Netherlands, LHs address the subject of Human Factors in their annual reports. Good examples are the LHs of the Borssele NPP (LH: EPZ) and the High Flux Reactor in Petten, (LH: NRG, owner European Union).

12.6 Human factors in organisational changes

Several of the LHs in the Netherlands are (or have been) engaged in processes of organisational change, often paralleling changes in their hardware. A significant reorganization was finished at the Borssele NPP in 2005. The reorganization meant to clarify the responsibilities; to shorten the management lines; to improve cross functional functions (particularly during outage); and anticipate and adjust the resources accordingly.

Since 2006 - after the decision of the government to agree with operating until 2034 - the plant is preparing for the future with an increased number of programmes. To meet the challenges of this task, the number of staff was increased and the plant's topmanagement was reorganized. Following the OSART-mission of 2014 and as these programmes progress, topmanagement changed back to a lean structure with clear and short lines of responsibility. Also the final closure of the coal-fired plant made this necessary.

12.7 Fitness for duty

In the Netherlands there are several laws that regulate the protection of the health and safety of employees. Examples are the law on working hours Act ('Arbeidstijdenwet') with the aim to keep personnel fit for duty and a specific law focused on a safe and healthy work environment ('Arbo-wet').

Furthermore, the nuclear safety rules require specific medical tests:

- Under NVR 3.2.1, control room operating personnel need to be in possession of a special licence. This is issued once the candidate has completed a specified period of training and passed an examination and medical test. The medical test is repeated every twelve months.
- Under NVR-NS-G-2.7, all site personnel who may be occupationally exposed to radiation at the nuclear power plant shall be subjected to an initial and to periodic medical examinations as appropriate.

In 2009, the management of the Borssele NPP introduced alcohol and drug tests.

12.8 Supervision

Human Factors and organizational issues related to safety have become more important subjects in all types of industries, including the nuclear industry. Organizational issues and Human Factors are getting the attention of ANVS in relation to work preparation, composition of teams, work execution, internal communication, process control and incident analyses.

The ANVS, is closely following the organisational changes within the organisation of the LH.

ARTICLE 13. QUALITY ASSURANCE

13. Each Contracting Party shall take the appropriate steps to ensure that quality assurance programmes are established and implemented with a view to providing confidence that specified requirements for all activities important to nuclear safety are satisfied throughout the life of a nuclear installation.

13.1 Introduction

The quality assurance programmes originally formally introduced at the nuclear installations in the Netherlands were based on the first IAEA Safety Series on QA. They have since been modified in line with international developments. A description of the initial period, the development of the programmes and cooperation between the parties involved was given in the Netherlands' first and second national reports on compliance with the Convention on Nuclear Safety.

In the nuclear sector, there has been a change of policy in the form of a shift from simply complying with a set of rules towards performance-based Quality Management Systems (QMSs) accompanied by processes of continuous improvement.

The importance of good safety management at nuclear installations is well recognized in the Netherlands. The aim of safety management is to formulate good safety policies for the relevant installation and this includes ensuring that the reasons, effects and consequences of those policies are communicated to all staff.

13.2 Regulations

The rules and guidelines on quality assurance for LHs in the Netherlands have been implemented as a Ministerial Order and are still based on the requirements and safety guides in the IAEA Safety Series (50-C/SG-Q), amended, where necessary, for specific use in the Netherlands. Separate from this, since 2011 relevant and updated NVRs are attached to the licence of the NPP, like NVR-GS-R-3, NVR-GS-G-3.1 and 3.5.

13.3 The integrated management system (IMS) at the Licence Holder

The managementsystem at the LH has been in place more than 20 years. The system has been renewed and complies with the international requirements (GS-R-3) and guidelines.

Over the last few years, the policies and elements of the revised IAEA guidance have been introduced in close consultation and cooperation with the management of this plant. Performance-based quality assurance has required a modification of the plant's written processes and instructions, together with a change in attitude on the part of management and staff. The use of critical success factors and of performance indicators has led to a process control based on more quantitative criteria. The interfaces with safety culture and safety management have added to the complexity of the introduction of the new IMS.

The interface of the IMS with Human Factors is important too. One aspect is the minimum staffing level for the various sections of a LH's organisation.

Specific attention also needs to be paid to the subject of outsourcing (subcontractors). The implementation of the EU-directive on nuclear safety version 2014 will introduce requirements also for the contractors.

13.4 Supervision of the management system by the Regulatory Body

The inspections by the ANVS are also covering the IMS of the LHs. Most of the nuclear installations in the Netherland are of a relatively high age. Due to this fact more attention has to be given to subjects as ageing and the assessment of the effectiveness of maintenance programs in use, in addition to the classical IMS approach.

ARTICLE 14. ASSESSMENT AND VERIFICATION OF SAFETY

14. Each Contracting Party shall take the appropriate steps to ensure that:

- i. **comprehensive and systematic safety assessments are carried out before the construction and commissioning of a nuclear installation and throughout its life. Such assessments shall be well documented, subsequently updated in the light of operating experience and significant new safety information, and reviewed under the authority of the Regulatory Body;**
 - ii. **verification by analysis, surveillance, testing and inspection is carried out to ensure that the physical state and the operation of a nuclear installation continue to be in accordance with its design, applicable national safety requirements, and operational limits and conditions.**
-

14.(i) **Assessment of safety**

Regulatory requirements

In the Netherlands, a licence is needed for the construction, operation, modification or decommissioning of a nuclear installation. Such a licence is only granted if the applicant complies with (among others) the siting requirements, the VOBK (including and its DSR-part) and with the probabilistic safety criteria. The latter include dose-frequency constraints within the design-basis envelope. Appendix 1 gives a detailed overview of the probabilistic safety criteria. NVR's on Design, Operation etc. are attached to the license of Borssele NPP.

The NVRs are fairly general and do not provide the technical detail found in national nuclear regulations of some other countries. However there is the VOBK, the Guidelines on the Safe Design and Operation of Nuclear Reactors - Safety Guidelines for short. These Guidelines provide new reactor licence applicants with detailed insight into what the ANVS considers to be the best available technology. Apart from this document, there are no nationally developed nuclear codes and standards in the Netherlands. Therefore additional material is needed to define the licensing basis. This includes parts of e.g. the US Code of Federal Regulations, the US NRC Regulatory Guides, the US NRC Standard Review Plan, the ASME code, the ANS/ANSI standards, KTA standards, and RSK recommendations. These documents have no formal status in the Netherlands. The NVRs require the applicant to specify and defend the technical basis and industry standards he is going to use. In this process, the ANVS expects the applicant to demonstrate that:

- the chosen set of foreign regulations and industry standards are consistent with the relevant NVRs;
- if more than one set of standards or regulations is to be applied, the various sets should be consistent.

To support his licence application, the LH shall draft (among others) a Safety report (SR) and a Safety analysis report (SAR), which he shall submit to the ANVS together with the application. The SR is the report that is attached to the licence, and as such it is a public document. It describes the organisation, the design, the outcomes of the safety analyses, etc. into some detail. The SAR gives a more detailed description of the proposed facility

and presents an in-depth analysis of the way in which it complies with the NVRs and other applicable regulations. Its claims are supported by detailed descriptions of the safety analyses, simplified system diagrams, and other supporting documents. To illustrate the difference between SR and SAR: the Borssele NPP SR is a one-volume document, whereas the associated SAR is a twenty-volume document. Both documents are updated with each modification of the installation, if there is a license application or licence renewal needed.

The SAR is supported by a Probabilistic Safety Analysis (PSA), comprising levels 1, 2 and 3 (see Appendix 3). The PSA – in particular the level-3 part of it – is needed to demonstrate that the facility meets the probabilistic safety criteria as laid down in the regulations (Bkse, see section on Article 7).

Review by the Regulatory Body, ANVS

In case of a licence application, the ANVS studies the SR in depth. The underlying and supporting documents are also reviewed in depth to ensure that the regulations have been met. In the review process, selected items are analysed with computer codes other than have been used for the original analyses provided by the LH. Often, assessments of similar power plants performed by a foreign regulatory body are also considered.

The ANVS often seeks the help of Technical Support Organisations (TSOs) like GRS, AVN and TÜV.

The ANVS has asked the IAEA to provide support to ensure the proper assessment and review of PSA results. The IAEA has undertaken peer reviews of the PSAs (the IPSART missions, formerly known as IPERS missions) and has given training courses in PSA techniques and PSA review techniques. Appendix 3 provides further information both on the role of the PSA in relation to safety assessment and on the associated regulatory review and guidance.

Once the reviews and regulatory assessments have been completed and it has been established that the applicant is acting in accordance with the rules, regulations and radiological safety objectives, the licence can be granted. The assessments are documented, as required by the ANVS internal QA process.

Periodic Safety Reviews (PSRs)

Since more than 20 years one of the conditions of the licence is that the safety of the nuclear installation is to be periodically reviewed in the light of operating experience and new safety insights. Since 2011 also the EU-directive on nuclear safety is applicable which contains a similar requirement. A review of operational safety aspects must be performed once every two years, whilst a more comprehensive safety review must be conducted once every 10 years. The latter involves a review of the plant's design basis in the light of new developments in regulations, research, safety thinking, risk acceptance, etc. The policy on back-fitting was first formulated in 1989. In 2011 the updated NVRs were implemented. At that moment also a new NVR on PSR came into force, based on the corresponding IAEA safety standard NS-G-2.10. The idea's of the 1989 document are fully covered by the IAEA document. Also the adopted WENRA policy on PSR is a further guidance today.

First 10-yearly Periodic Safety Review

In the late 1980s, mainly as a result of the Chernobyl accident, the Dutch government formulated an accident management and back-fitting policy for the two NPPs in operation at the time. Both utilities were asked to upgrade the safety of their plants by incorporating state-of-the-art features and investigations of possible ageing, and hence to guarantee safe operation in the next decade. With the aid of the respective reactor suppliers, the two utilities developed a new safety concept for their plants in the early

1990s. The safety issues were very much related to lack of separation, lack of redundancy and lack of resistance against external events. This first formal ten-yearly safety evaluation of the Borssele NPP has resulted in the MOD-modification project. This project, which was concluded in 1997, has led to a level of safety that complied with the current risk standard of the Dutch government. For this purpose, major investments have been made, mainly for physical separation of redundancies (mostly concerning design aspects) and to a lesser extent for Organisational, Personnel and Administrative (OPA) provisions.

In Appendix 5, a detailed description is given of the modifications of the Borssele NPP resulting from this first 10-yearly periodic safety review.

Second 10-yearly Periodic Safety Review

In the beginning of 2004 a second ten-yearly safety review of the Borssele NPP was finalised. It included a safety evaluation of the period 1993-2002, the drawing-up of proposals for adaptations of the technical, organisational, personnel and other provisions to achieve state-of-the-art conformity, as well as the implementation of the proposed measures. This second ten-yearly safety review resulted in a fine-tuning of the safety concept of the plant rather than major changes.

Specific attention in this safety review was paid to:

- International developments and views relating to e.g. back-fitting programmes and other reactor designs;
- Ageing, including selection of the Structures, Systems and Components to be reviewed and ageing management;
- State-of-the-art PSA analyses;
- Evaluation of good practices;
- Safety analyses with respect to external conditions;
- Accident management and severe accidents;
- Fire protection.

In Appendix 5 an overview is given of the most important technical, organisational, personnel and administrative measures due to the evaluation.

Third 10-yearly Periodic Safety Review and Long Term Operation

In compliance with the licence the LH issued a third 10-yearly safety review at the end of 2013. The Safety Report (VR93) contained a statement that the design of the plant is based on an operating period of 40 years starting from 1973. Therefore the LH had to apply for a licence approving Long Term Operation (LTO) supported by sound evidence that the plant can be safely operated for a longer period. It was agreed by the ANVS and EPZ not to combine the two subjects of LTO and PSR but to execute two complementary projects, each having its own time frame. The LTO project resulted in a licence application that was submitted for regulatory review in 2012, the licence was granted in 2013. The LTO project was carried out using IAEA Safety Report Series 57, complemented with two safety factors: SF10 Organisation, Management System and Safety Culture and SF12 Human Factors from the IAEA guidance on PSR.

The LTO process was supported by a limited scope IAEA SALTO mission in 2009, with the aim to see if the LTO-programme and approach was comprehensive and according to the state of the art. At the end of the LTO programme and in the phase of the licensing a full scope SALTO mission was carried out in May 2012, covering also the follow up on the mission in 2009. The final LTO-licence was given in March 2013, including the provision to complete the measures based on the SALTO mission recommendations before the end of 2013. In February 2014 the final follow up SALTO mission has been carried out. In Appendix 8 the recommendations and measures, including the status, are listed.

During the 3rd PSR amongst others the following steps were relevant:

- DS426, update version of IAEA NS-G-2.10 was used as guidance
- A benchmark study of PWRs of the same age and with LTO
- A benchmark study of the EPR (including Finnish regulations) and AP1000
- Study of the 2010 WENRA document "Safety objectives for new reactors"
- Modernization of deterministic safety analyses
- Lessons learned Fukushima Daiichi accident
- Use of PSA to determine potential safety improvements

Eleven measures agreed after the 3rd PSR required a modification of the licence. Together with the modification, a revision of the licence was requested by EPZ. As part of the application a revised Safety Report was submitted to the ANVS. More details on improvements can be found in Appendix 5.

Comprehensive safety analysis following the Fukushima Daiichi accident (European stress test)

The European stress test has been carried out in 2011 and was peer reviewed on at European level in 2012. In the middle of 2012 the ANVS in agreement with the LH requested to implement a set of measures according to a detailed schedule. The measures and the planning have been published in the National Report on the 2nd extraordinary CNS in 2012. These measures are not considered the final improvements based on the lessons learned from the accident, because more information will become available in the future. More details about the implementation of the measures (status 1-4-2016) are:

- Robust emergency response center (ERC); a proposal is being made by licensee EPZ. In this proposal the ERC will be realized by combining several existing buildings on-site in combination with an off-site back-up facility situated at least 10 km from the NPP. ANVS made an assessment of this proposal and made comments mainly with respect to the robustness against external hazards and the communication means. The remarks have to be taken into account by the NPP in the further design of the ERC.
- Station blackout while in midloop operation, improve the emergency injection from the buffertanks (discussed during the Country Peer review); formal instruction has been implemented in 2013 and 2014 after testing at the plant simulator and training. A modification plan for the operation of the motor operated valves in case of a SBO has been compiled and will be implemented in 2017.
- Three seismic acceleration detectors, two in a building and the third in the free field and all provided with Uninterrupted Power Supply (UPS) systems are implemented in 2013.
- Study flooding/superstorm is ready. This report learns that the maximum flood level with superimposed waves is lower than the design flood level of the plant. As the plant is already designed according to a higher flood level than the most recent requirements, additional margin has been 'gained' and extra measures to increase the margin even further are not selfevident.
- Measure to fill the wet fuel pond, without entering the containment building has been implemented; one of the actions is to connect two systems with a 30 meter fire hose. Next to this an additional possibility to refill the spent fuel pool is analysed and will be implemented in 2017.
- The measure to reduce the time required to connect a large mobile diesel generator to just two hours has been implemented. These two hours include the time to move the generator to the spot and the time to connect it.

- Mobile equipment has been bought and stored in the on-site waste storage building; the emergency response plan has been adapted. Final location of the additional mobile equipment will be determined in relation to the location of Emergency Response Center.
- Airplane crash: a study has been completed to determine the possible effects based on international insights, experience and guidance. ANVS is reviewing the study, with support of GRS and will exchange information with a number of other countries during 2016.
- Increase of autarky time: a modification proposal has been developed. The improvements have not been implemented yet.
- Seismic Margin Analysis (SMA): new information from studies has revealed that the PGA at the NPP site is larger than the DBE. An updated seismic hazard (called RLE) of roughly 50% higher value than the DBE has been determined. New calculations using the RLE are ongoing to determine if modifications are necessary. Relevant equipment is assessed against a PGA of 0.3g to determine margins and reasonable measures to increase these margins.
- Reinforcement of external power supply will be implemented in 2017.

An overview of the implementation of the 'stress test' measures can be found in Appendix 9.

Safety Assessments related to modifications

Significant changes to the installations that imply changes to the design assumptions, as laid down in the safety report, require a licence change. New safety analyses have to be performed to demonstrate that the safety impact of these modifications remain within the prescribed limits. An example of a change requiring a safety analysis is the following.

In the late nineties the safety report and some safety analyses were updated when the LH of the Borssele plant submitted a request for a modification of the licence in order to be able to use higher enriched fuel elements (from 3.3% up to 4%). External experts were consulted for the review. There was special emphasis on issues associated with high burn-up fuel in relation with prevention of reactivity insertion accidents (RIA-accidents). The review was repeated at the end of 2003. A modification of the licence was requested to use 4,4% enriched fuel and a burn-up limit for fuel rods averaging 68 MW day/kg U by using the new Niobium-Zirconium cladding material M5 (Framatome) with an improved corrosion behaviour. Up to now the average burn-up of the fuel never exceeded 60 MW day/kg U due to the constraints (heat, radiation) imposed by the specifications of the spent fuel containers. The power plant shall provide additional tests of the fuel quality before going from 60 to 68 MW day/kg U for the whole core.

In 2010 a licence application was sent to the ANVS for the introduction of MOX-fuel. The MOX-licence became irrevocable in 2013. The first reload was in 2014.

In 2017 the digitalisation of the electronics of the Reactor Control and Limitation System (RCLS) will be implemented. In 2015-2017 this requires a lot of effort. The ANVS is supported in this task by GRS.

Safety assessments initiated by the LH or RB – audits and peer reviews

Apart from the assessments of the impact of proposed operational or design changes on safety or the periodic safety reviews, which are both regulatory and institutionalised requirements, the LH regularly performs self-audits, or requests audits or peer reviews by others in order to evaluate its own operation. Also the regulator may request a peer review. In particular the Organizational, Personnel and Administrative aspects of operation are subjects for most of these audits and peer-reviews. Examples of this practice are the WANO-Peer Reviews in 1999 and 2008 (see Article 10) and a second

OSART mission to the Borssele NPP in 2005. At least every 10 years there will be an OSART mission at the NPP. The WANO peer review frequency has been increased to once in 4 years after the Fukushima Daiichi accident. The most recent missions were IPSART 2010/IPSART Followup 2013, SALTO limited scope mission 2009/fullscope mission 2012/followup in 2014, OSART 2014, WANO-Peer review 2016. In Appendix 8 the main findings of the most recent missions are listed. In the second half of 2016 and 2017 the OSART FU will take place in two stages.

Supervision by the RB

After a licence has entered into force the ANVS assesses the implementation. This means in practice that the LH is required to send detailed documentation about safety relevant modifications which will then be reviewed before final implementation. During implementation inspections are carried out. ANVS supervises for instance the implementation of the stress test measures, the MOX licence, the LTO-licence and after 2013 the improvements from the 3rd PSR. ANVS often seeks the help of a Technical Support Organisation (TSOs) like GRS.

14.(ii) Verification by analysis, surveillance, testing and inspection

In general, the LH is responsible for inspecting and testing all NPP equipment and systems in order to guarantee their safe operation.

EPZ performed an LTO assessment to justify safe operation with Borssele NPP until 2034. In this LTO assessment a specific verification of the existing 5 plant programmes (maintenance, surveillance, in-service inspection, chemistry and equipment qualification) was performed. It could be shown that the 9 attributes according to IAEA Safety Report 57 are adequately fulfilled in the programmes.

The regulatory authority checks that the inspection and test programme is adequate for this purpose.

The relevant NVRs are NVR-NS-G-2.6 (Maintenance, Surveillance and Inspection) and NVR-NS-G-2.1 for fire protection. In addition, the licence requires that the Borssele NPP has an ageing management system for all structures and components important to safety, so as to enable plant management to take appropriate action in time. A specific department at the Borssele NPP reviews information on ageing of structures and components. This includes internal information (maintenance, in-service inspection etc.) and external information (event reports on ageing, direct information from other plants etc.). This ageing experience feedback programme operates in addition to the existing programmes involved in ageing management (in-service inspection, maintenance, chemistry monitoring etc.).

Based on the results of a comprehensive Ageing Management Review performed in the LTO assessment, EPZ is further improving the existing ageing management process by introducing a specific procedure on ageing management of passive structures and components important to nuclear safety in the plant. This procedure is owned by the aforementioned department and is particularly important to improve coordination and traceability of ageing management activities. NVR-NS-G-2.12 is the basis for this procedure. Using this procedure, several recommendations from the LTO Ageing Management Review will be implemented.

The assessment and inspection of the integrity of pressure retaining components is subcontracted to a Notified Body, Lloyds Register Nederland BV. The assessments and inspections of the Notified Body are performed under supervision of the ANVS.

The ANVS conducts regular inspections and audits to check the other inspection and test activities at the power plant. All additional reviews and inspections carried out in

response to the occurrence of hydrogen flakes in the Belgian Doel/tihange plants did not reveal such occurrences in the Borssele NPP.

The current licence of the Borssele NPP includes a requirement for a Living PSA (LPSA). The reason for this is that the ANVS recognises an LPSA as being a suitable and sufficiently mature instrument of analysis to support certain aspects of safety-related decision-making in matters of design or procedures. These LPSA applications can reveal the effects of apparently insignificant changes in design or operating procedure. The requirement in the licence is qualitative. It means that the PSA must reflect the latest configuration of the plant and that the PSA must be used by plant staff when making safety-related decisions. In that respect, the NPP uses a risk monitor, e.g. for configuration control during outages.

An important aspect in the assessment of safety is the ability of the assessor to make use of the state-of-the-art. Therefore, experts of the LH participate in audit and peer-review teams of IAEA and WANO to evaluate other plants. The insights gained from these participations are used in their assessment work at Borssele NPP.

At Borssele NPP, the internal safety review of technical and organisational modifications is organised as follows:

- Technical: All aspects of technical modifications relevant to safety are documented in a 'Modification Plan'. This report is verified by all relevant specialists. After their comments have been taken into account, the report is independently reviewed by staff in the Safety Design Department. Once accepted by this department, the original report and the independent review report are sent to the Internal Reactor Safety Committee to advise the Plant Manager for authorisation. The last step in the review is an assessment under the authority of the RB. In the case of minor modifications likely to have no impact on safety, a simplified procedure is applied.
- Organisational: Proposals for organisational modifications are prepared by the Human Resources Management Department. The final proposal is outlined in a report describing the changes relating to the organisation (structure, tasks/responsibilities, systems, documents, staffing and potential associated impact on nuclear safety). The (internal) independent nuclear safety officer checks the final proposal against all the organisational requirements laid down in the licence, NVRs (amended IAEA codes and guides) and other relevant regulatory documents and produces a report on his findings. The two reports (the final proposal and the independent verification) are then reviewed by the internal and external reactor safety committees of the Borssele NPP before being submitted to the authorities.

ARTICLE 15. RADIATION PROTECTION

15. Each Contracting Party shall take the appropriate steps to ensure that in all operational states the radiation exposure to the workers and the public caused by a nuclear installation shall be kept as low as reasonably achievable and that no individual shall be exposed to radiation doses which exceed prescribed national dose limits.

15.1 Radiation protection for workers

Current legislation

As stated in the section on Article 7, the basic legislation on nuclear activities in the Netherlands is the Nuclear Energy Act. A number of Decrees have also been issued, containing more detailed regulations based on the provisions of the Act. The most important Decrees in relation to the safety aspects of nuclear installations and the radiological protection of workers and the public are:

- the Nuclear Installations, Fissionable Materials and Ores Decree (Bkse); and
- the Radiation Protection Decree (Bs).

These Decrees are fully in compliance with Council Directive 96/29/Euratom establishing basic safety standards for the protection of the health of workers and the general public against the dangers arising from ionising radiation.

Bkse requires the Licence Holder (LH) of every nuclear power plant to take adequate measures for the protection of people, animals, plants and property. Article 31 of Bkse states that a licence must contain requirements aimed at as far as possible preventing the exposure and contamination of people, animals, plants and property. If exposure or contamination is unavoidable, the level must be as low as is reasonably achievable.

Bkse also states that these activities must be carried out by or under the responsibility of a person judged by the Regulatory Body (RB) to possess sufficient expertise. This expert must occupy a post in the organisation such that he or she is able to advise the management of the NPP in an adequate way and to intervene directly if he or she considers this to be necessary.

Written procedures must be available to ensure that the radiological protection measures that have to be taken are effective and to ensure that the aforementioned expert is properly informed. Full details of these conditions are given in the Radiation Protection Decree (Bs), which also lays down more specific requirements for the protection of people and the environment from radiation.

In conformity with the Euratom basic safety standards, the Radiation Protection Decree stipulates a limit of 20 mSv per annum as the maximum individual effective dose for radiological workers. In practice, no cases have been recorded which exceeded the 20 mSv per annum standard. If a problem should occur, there is an article in the Radiation Protection Decree that permits a higher dose in exceptional situations subject to stringent conditions. To date, the nuclear installations in the Netherlands have never experienced such a situation.

Implementation by the Licence Holder of Borssele NPP, EPZ

The LH has set a dose constraint of 6 mSv per annum as the objective for the individual effective dose limit for radiological workers at the Borssele NPP. The LH furthermore applies a 5 years average of 3 mSv per annum. This means that a radiological worker who receives a dose of 7 mSv during a particular year should receive less during

subsequent years, until his average dose (averaged over 5 years) is no higher than 3 mSv per annum.

The average effective individual dose for both in-house personnel and externally hired personnel at the Borssele plant has shown a decreasing trend since 1983. The average effective individual dose over the last two years has been about 0.5 mSv per annum. Over that period, the trend in the collective dose has been very similar to that of the individual doses. In the early eighties, the total collective dose amounted to 4 manSv per annum. Over the two decades it decreased to about 0.3 manSv per annum. See Annex 1 for details.

Since 2009 the collective dose is rising due to the many extra activities and monitoring that are needed due to the LTO programme. Executing the LTO Programme is essential to keep satisfying the requirements imposed by the RB on the ageing NPP. In 2010 the total collective dose was about 0.6 manSv. In 2011 and 2012 the collective dose was about 0.3 manSv, 2013 showed a peak related to LTO activities, after which the dose dropped substantially. Refer to Appendix 5 for more details.

One of the conditions of the licence issued to the Borssele NPP is that the manager responsible for radiation protection should be adequately qualified. The person in question is also required to hold a sufficiently independent position in the organisation to allow him to advise the plant or site manager directly on all matters of radiation protection. A precise description of the requirements for this manager's qualifications, as well as the qualifications which a number of other radiation protection officers need to possess, is given in the Technical Specifications (TS). The appropriate training programme covers the qualifications of the other officers.

Personal dosimetry records

Article 90 of the Bs Decree⁶⁸ requires that the operator records doses incurred by each exposed worker using personal dosimetry. Regarding personal dosimetry no distinction is made between Category A and category B workers. Only dosimetry services approved by the Ministry of Social Affairs and Employment (SZW) are allowed to provide dosimeters, to assess the received dose and to manage the dose records of exposed individuals.

Dose summaries of all dosimetry services are made available to the National Dose Registration and Information System (NDRIS). NDRIS has been established in 1989 by the Ministry of SZW. The main objectives of NDRIS are to preserve dosimetric data for the period required by the Euratom Basic Safety Standards and to bring together all data from all registered radiation workers, including those of foreign workers whose data are identified through the radiation passport.

NDRIS is managed by NRG, department of Radiation & Environment. In the beginning only data from individuals employed at institutes which had subscribed to the dosimetric services of NRG (and its predecessors) were collected but gradually also data from other approved dosimetric services were added. In 1994 and 2002 respectively, NDRIS was extended with data from external workers and with data from aircraft crew. NDRIS generates statistical data with the following features:

- personal data;
- social security number;
- dosimetric data;
- branch of industry (e.g. hospitals, nuclear industry);
- job category (e.g. veterinary X-ray diagnostics, radioactive waste treatment).

⁶⁸ Decree on radiation protection.

NDRIS is designed to process the collected data, to make statistical analyses of the recorded doses and to present various cross-sections for management purposes. It enables employers to collate information on occupational doses and to optimise operational radiation protection.

Reporting of worker doses

The current licence of Borssele NPP requires that the LH monitors, quantifies and registers all relevant radiological data. It also specifies the situations in which (and the terms on which) it must inform the RB. Another example of a 'radiation protection'-related requirement in the licence is the LH's obligation to monitor and record the radiation levels and levels of contamination at those locations where workers may receive an effective dose of 5 microSv or more in less than one hour.

Workers who work in places where there is a risk of internal contamination must be checked for this at least once a year. The results must be documented and kept for inspection purposes.

The LH is required to report to the RB every three months the individual doses received by workers who work at locations where they are exposed to an effective dose of at least 5 microSv in less than one hour. If a worker has received an effective dose exceeding 15 mSv within a period of three months, the LH must investigate all the circumstances that could have caused this dose level and must inform the RB of the results. These results have to be reported to NDRIS and are being kept in that system for at least 30 years.

The licence also requires the Borssele NPP to comply with the amended IAEA codes and Safety Guides (i.e. the NVRs). In the domain of radiation protection, Safety Guide NVR-NS-G-2.7 complements the requirements set by the Radiation Protection Decree (Bs), and lays down more specific requirements for:

- the lay-out of the controlled zones;
- the facilities within the controlled zones;
- staff qualifications and training; and
- the radiation protection programmes.

In order to comply with all the radiological conditions, the LH must have adopted adequate procedures for the implementation of such a radiation protection programme. The RB inspects the site to check the effectiveness of these procedures.

Prior to any reactor outage, the LH must give the RB an estimate of the anticipated collective dose. Once the outage activities have been completed, the LH must produce a dose evaluation report and inform the RB of the results.

If the anticipated collective dose relating to any job exceeds 10 man-mSv or the maximum individual effective dose is greater than 3 mSv, the RB will request the LH to produce an ALARA report showing that it has indeed taken the best possible radiation protection measures. The ICRP-60 publication is used as a guideline for this optimisation process. The criteria or considerations for submission of ALARA reports are based largely on a qualitative judgement rather than a quantitative assessment. The choice of the 10 man-mSv limit is pragmatic and is motivated by the legal difficulties concerning the definition of a specific job and the dose history associated with previous jobs.

15.2 Radiation protection for the public

The licence of the Borssele NPP requires the LH to comply with the amended IAEA Safety Guides (i.e. the NVRs). The Safety Guide NVR NS-G-2.7 'Radiation Protection and Radioactive Waste Management in the Operation of NPPs' complements the requirements set by the Radiation Protection Decree (Bs). More specific requirements are laid down in

the Technical Specifications of the NPP. Also refer to Appendix 5, 'TECHNICAL DETAILS OF BORSSELE NPP'.

The monitoring of all discharges in air and water has to comply with the German regulations 'Sicherheitstechnische Regel des Kerntechnischer Ausschuss (KTA) 1503 and 1504'. The actual releases are normally less than 5% of the discharge limits (Appendix 5).

The design of the installation is the first step towards achieving the radiological safety objectives. The Safety Report (SR) must demonstrate that the design of the plant and planned operational conditions and procedures comply with these objectives. In addition, the radiation dose received by members of the public due to the operation of the NPP, including the discharges of radioactivity in water and air, must be controlled and optimised (ALARA) whenever the plant is in an operational state.

In article 48 of the Bs a source constraint amounting to one tenth of the annual effective dose limit for the population has been set for any facility. Both the LH (Borssele) and an independent institute (State Institute for Public Health and the Environment, RIVM) monitor the radiation levels at the border of the site continuously.

As prescribed in the licence, all discharges of radioactive effluents must be monitored, quantified and documented. The LH must report the relevant data on discharges and radiological exposure to the RB. On behalf of the RB, the National Institute for Public Health and the Environment (RIVM) regularly checks the measurements of the quantities and composition of discharges.

The LH is also required to set up and maintain an adequate off-site monitoring programme. This programme normally includes measurements of radiological exposures (with Thermo luminescence Dosimeters, TLDs) and possible contamination of grass and milk in the vicinity of the installation. The results are reported to – and regularly checked by – the Regulatory Body. Under Article 36 of the Euratom Treaty, each year, the discharge data must be submitted to the European Commission. The discharge data are also reported to OSPAR, the Convention for Protection of the Marine Environment in the North-East Atlantic.

Non radioactive materials and wastes are closely examined before release from the site, based on the rules in Bs and the licence. Radioactive waste is handled in accordance with Bs and the licence. The radioactive waste is sent to COVRA. The LH keeps records of the handled wastes and these will be regularly checked by the RB.

The framework for off-site nuclear and radiological emergency response, is described in the text under Article 16.

ARTICLE 16. EMERGENCY PREPAREDNESS

16.1 Each Contracting Party shall take the appropriate steps to ensure that there are on site and off site emergency plans that are routinely tested for nuclear installations and cover the activities to be carried out in the event of an emergency. For any new nuclear installation, such plans shall be prepared and tested before it commences operation above a low power level agreed by the Regulatory Body.

16.2 Each Contracting Party shall take the appropriate steps to ensure that, insofar as they are likely to be affected by a radiological emergency, its own population and the competent authorities of the States in the vicinity of the nuclear installation are provided with appropriate information for emergency planning and response.

16.1 Emergency plans

In this section, on-site and off-site arrangements are discussed in separate sections. The information about on-site issues is focused on the Borssele NPP.

16.1.a On-site: SAM

Regulatory framework

The Dutch Nuclear Energy Act (Kew) sets the framework for nuclear safety management. As explained in the chapter on Article 7, beneath this Kew, 'Decrees' provide for additional regulations, including provisions for licensing and requirements for risk assessments, and especially those for severe accidents.

Examples of regulatory documents attached to the license of the Borssele NPP, highly relevant for on-site emergency preparedness, are:

- NVR NS-G-2.15 'Severe Accident Management Programmes for NPPs'
- NVR GS-G-2.1 'Arrangement for Preparedness and Response for a Nuclear or Radiological Emergency'
- NVR GS-R2 'Preparedness ans for a Nuclear or Radiological Emergency'

Licence condition 23 of the Borssele NPP requires the Licence Holder (LH) to establish and maintain an emergency plan and an emergency organisation, and also to ensure that exercises are conducted regularly. The on-site emergency plan and emergency organisation must be consistent with the off-site emergency planning as defined in the National Nuclear Emergency Management and Response Plan.

In principle, the approach adopted in the Netherlands enables regulation in accordance with current international practice, and to be flexible in adopting further requirements if this changes. The Dutch legal framework gives the RB adequate powers to require any Severe Accident Management (SAM) measures it deems necessary, the main instrument being through the operating licence.

The Decrees include specific requirements for numerical risk. These are general requirements that apply to all industrial activities in the Netherlands. From this, risks need to be less than: 10^{-6} per year for individual risk (mortality) as a consequence of operating an installation; 10^{-5} per year for societal risks, i.e. risks directly attributable to

events leading to 10 or more fatalities. Supplementary criteria are also applied, requiring a hundredfold reduction in this limit for each tenfold increase in the predicted number of fatalities.

The LH has conducted complete Level 1, 2 and 3 PSAs, which include external hazard initiators. The full scope Level 3 PSA (which utilises the COSYMA computer program) results in estimated risk levels compliant with the regulatory criteria outlined above. These are "living" PSAs, i.e. they are updated yearly. They also provide input to the surveillance and maintenance strategies, modification planning and execution, and periodic safety assessments, the so-called "risk monitor".

The full scope Level 3 PSA has been used to derive LH's (EPZ) SAM strategy.

SAM strategy at the LH

The on-site emergency plan includes a specific emergency organisation with adequate staff, instructions and resources.

The emergency plan has three principal goals:

- to ensure that the operating organisation of the NPP is prepared for any on-site emergency situation;
- to mitigate as much as possible the effects on the operating personnel of the NPP and on the environment in the vicinity of the plant;
- to advise the relevant governmental bodies as effectively as possible on emergency actions that should be taken.

SAMGs

Currently two parallel strategies are applied to manage a severe accident. In principle the SAMGs conservatively assume that the corium will ultimately penetrate the basemat and the corresponding strategy is to prevent a high-pressure melt-through scenario. Since this is a very conservative assumption, the SAMGs also take into account that a coolable configuration of the corium will be reached due to the spreading of the corium. The associated strategy is to enhance cooling of the corium by supplying water (through the damaged reactor vessel) to the corium. The LH is currently reviewing international research to better underpin these strategies. In addition during the 3rd PSR it has been found that, in contrast with the past, the in-vessel retention is feasible and this major improvement in the chain of defence in depth is planned to be implemented during the refueling in 2017.

Severe Accident Management Guidelines (SAMGs) have been in operation at Borssele NPP since 2000 as an outcome from the PSR at the plant in 1993. Their scope was expanded following the 2003 PSR to include shutdown conditions. The SAMGs are based on the generic SAMGs produced by the Westinghouse Owners Group and were considered state of the art in 2003. Fukushima lessons learned that more is needed, which is or will be implemented in the near future. They are intended to address scenarios deriving from severe external hazards, such as earthquakes and floods, where there is the imminent potential for core melt.

The SAMGs include guidance for using the pressure relief valves and various pressuriser spray options to control the Reactor Pressure Vessel (RPV) pressure. For an ex-vessel event the containment (37,100m³) has filtered venting, a spray system, air coolers, a filtered recirculation system and Passive Autocatalytic Re-combiners (PARs). The containment is designed for overpressures of 3.8 bar.

Classification

The incident/accident classification system used by the Borssele plant is in line with the classification system used in the so-called Response plan NCS. This, in turn, corresponds to the IAEA emergency classification system. In the terminology at the NPP the classification is: 'Emergency Stand-by', 'Plant Emergency', 'Site Emergency' and 'Off-Site Emergency'. This differs a bit from the IAEA terminology. The various types of emergency procedures, and the emergency plan and the emergency organisation of the operating organisation, are sent to the RB for review and approval.

Communication of the LH with the RB in emergency situations

If an emergency occurs, the plant management must inform the relevant authorities immediately, advise them of the classification of the accident, and provide whatever information is required in order to assist the ANVS to assess the nature and potential consequences of the accident, to determine the potential for mitigating its effects and to make a prognosis of potential radioactive discharges. Real-time data and process information is available to the ANVS. This is part of the plant information supplied to the ANVS during an emergency. The ANVS has a strict 24/7 schedule to secure its availability during any actual or potential accident or serious incident.

SAM facilities at the LH

Borssele has standard arrangements for controlling the plant in the event of a severe accident. The Main Control Room (MCR) has a filtered air supply and, following a Station Black Out (SBO) event, compressed air and respirators are available. There is also an alternative Emergency Control Room (ECR, which is bunkered and has gas-tight doors, but which does not have a filtered air supply) for managing a controlled shutdown, core cooling and spent fuel pool cooling. Both the MCR and ECR have suitable and robust access to plant measurements needed to control a severe accident.

There are seven operations shift teams at Borssele, each managed by a shift supervisor and each composed of at least eight operators. It is the shift supervisor's responsibility to decide on the extent of the LH's Emergency Response Organisation (ERO) that needs to be activated. Once the ERO is operational, the site emergency director takes over responsibility for the emergency. Based on data from exercises, the ERO will be set up within 45 minutes (also outside normal working hours) and then requires a further 30 minutes to become operational.

The ERO is a scalable organisation: the number of staff called in (by pagers, phone calls) will depend upon the scale of the emergency being addressed. The ERO will be located in the plant's Alarm Coordination Centre (ACC). This is a purpose-built facility designed for internal events and emergencies. Though bunkered (like the ECR), it is not designed to withstand severe events such as a major earthquake, flood or aircraft crash

Evaluation of SAM capability and (potential) safety improvements

In the European ENSREG-led Complementary safety Assessment or 'stress test', EPZ has evaluated his SAM capability and has judged it adequate, although noting several options for improving on this capability. The ANVS has reviewed the findings which resulted in refinement of the list of actions. A list of numbered actions and topics for further research can be found in the table in the Summary of the present report. Examples of notable improvements are discussed below.

When EPZ's Emergency Response Organisation needs to be activated, it will be located in the plant's Alarm Coordination Centre (ACC). A plan to improve the ERC facilities will be implemented in 2017. In the meantime, the ERO will need to relocate, if the ACC

becomes uninhabitable, to a standard meeting room. This will however entail losing much of the functionality (e.g. communications provisions) of the ACC. Interim measures are therefore implemented to enhance the capability of some of the meeting rooms on site (though not to the same standards as the ERC will have), pending full ERC commissioning. During the CNS review meeting in 2017 probably more can be explained.

The LH is currently in the process of developing further its set of Extensive Damage Mitigation Guidelines (EDMGs). They address gross infrastructure problems deriving from a major incident, e.g. blocked roads, or doors no longer amenable for access.

Training of the emergency organisation of the LH

The training requirements are described in the various procedures and in the manual on emergency drills. The plant management is required to provide a schedule of regular emergency drills and classroom training. A part of the obligatory training plan for shift staff is devoted explicitly to teaching them how to deal with emergencies.

Training and emergency exercises are conducted routinely and include change-over of ERO shifts. Scenarios are controlled using the plant's full scope simulator (located in Essen, Germany), though it is noted that this cannot simulate severe accidents. Emergency exercises can be very large scale, e.g. a national exercise in 2011 involved 1000 people. The LH produces an annual summary report of its exercises which is assessed by the regulator. The inspectorate branche of the ANVS participates in six emergency exercises annually. One or two ANVS-inspectors are based at the ERO location to observe the exercise and to check if the correct measures are taken to restore safety functions.

The larger exercises incorporate the participation of the various government organisations at local, regional and national levels. The last full-scale exercises were in May 2005 and September 2011. The next one is planned at the beginning of 2018.

The LH has learned from recent exercises that it is necessary to have a sound communication plan for emergency situations. This plan is being written. Communication with external entities is found to be complicated and therefore always is a focus point of the exercises. In the current arrangements, LH EPZ has a liaison who is sent from the plant to the local authorities to explain the emergency situation. This arrangement is found to be very useful. Therefore it has been decided to train the liaison in all exercises the authorities participate in. The LH also learned that the number of the emergency staff on some functions had to be doubled because of the workload they may have during an emergency. It was also experienced that the preparations of large exercises with external parties, must start early. Especially the determination of the objectives of the exercise, needs thorough consideration.

16.1.b Off-site: EP&R and PAM

Off site emergency preparedness and response (EP&R) and post accident management (PAM) mainly is a responsibility of the authorities. Nevertheless utility's responsibility is also important especially regarding providing technical information on plant conditions and the potential risk for emissions.

The present section gives a general introduction to the EP&R and PAM in the Netherlands. The developments and actions regarding EP&R and PAM have been discussed.

Regulatory framework

Chapter VI of the Dutch Nuclear Energy Act among others describes the responsibilities and tasks of the authorities that are responsible for nuclear emergency management (preparation and response).

Under Article 40 of the Act, the national government is responsible for the preparatory work and for actually dealing with any emergency that may occur in case of nuclear accidents. The operational structure of nuclear emergency preparation and response is based on Article 41 of the Act and is detailed in the National Crisis plan⁶⁹ for Radiation incidents: NCS (Dutch: 'Nationaal Crisisplan Stralingsincidenten') and the Response Plan NCS. The NCS describes the measures and mandates that are available to the national authorities during a nuclear accident. It refers to other related documents that address the management of radiation incidents like the Response Plan NCS.

Responsibilities of ministers

The Minister of I&M coordinates efforts on emergency management specific to nuclear accidents of national relevance (the 'category-A accidents'). The Minister of Security and Justice ('Veiligheid en Justitie', V&J) coordinates efforts on the general management of accidents at the national level and oversees the preparation and maintenance of regional crisis management plans (for all types of incidents). It is also responsible for the National Crisis Center (NCC) that serves as national coordination center during incidents when the involvement of various ministries is required. The Minister of V&J is also responsible for maintaining order and guaranteeing security. The other ministers have responsibilities that are linked to areas that are specific for their own ministries. Examples are:

- Minister of Health, Welfare and Sport for medical aspects and public health;
- Minister of Social Affairs and Employment: for safety at work;
- Minister of Defence: for accidents with military nuclear materials;
- Minister of Economic Affairs: also for agricultural aspects and safety of food stuffs;

All ministers are responsible to maintain an adequately educated and trained emergency management unit and a coordination centre for the areas that are in their domain

National Organisations for EP&R and PAM

The operational structure of nuclear emergency preparation and response is embedded in the National Crisis plan for Radiation incidents, NCS.

With accidents of national relevance (Category-A accident) the national nuclear assessment team EPAn⁷⁰ is activated. This team advises whenever there is a real threat of an off-site emergency in a nuclear installation or a radioactive release in the Netherlands or in a neighbouring country. EPAn may give advice on mitigating measures. The EPAn has the following components:

- A Front Office (FO) coordinating the advice on the national and regional level to various entities like the Regional Policy Team ('RBT'⁷¹, acting at the regional level near the NPP), and on the national level the Advice Team ('AT'), the Commission Coordination Emergency Management ('ICCb') and the ministerial Commission Crisis Management ('MCCb').

⁶⁹ Formerly known as National Nuclear Emergency Plan, NPK ('Nationaal Plan Kernongevallenbestrijding')

⁷⁰ Dutch: 'Eenheid Planning en Advies nucleair', EPAn

⁷¹ Dutch: RBT, 'Regionaal Beleidsteam'

- One Back office, the Crisis Expert Team (CET) – radiation providing the Front Office with situation reports, analyses and prognoses regarding the accident at hand, also indicating if and where intervention level will be exceeded, requiring mitigating radioprotection measures and medical interventions

The CETs⁷² is a network of nine Dutch centers of expertise on crisis management:

- ANVS/Task Force, section of ANVS dealing with crises. The Task Force has an important role in assessing the status of the relevant nuclear installation, the accident prognoses and the potential source term. In addition, ANVS inspectors go to the accident site to closely monitor the event and support the oversight process
- Ministry of Defense, section CEAG – coordination center expertise work environment and health
- KNMI, royal Dutch meteorological institute
- NVWA, Dutch authority on food and consumer goods
- KWR, Dutch watercycle research institute
- Rijkswaterstaat, the public body in the Netherlands responsible for the design, construction, management and maintenance of the main infrastructure facilities in the Netherlands
- RIKILT, Dutch institute of Wageningen university specialised in detecting substances in food
- RIVM, National Institute for Public Health and the Environment. RIVM can provide for radiological information on projected dose data on the basis of dispersion calculations and on monitoring data concerning the environment, drinking water and foodstuffs. RIVM operates the national radiological monitoring network (NMR⁷³) and in addition monitoring vans. It also collects data from other institutes.
- UMCU/NVIC, national center at Utrecht academic medical center for toxicology

With incidents with potential consequences limited to a local or regional scale (Category-B accidents), CETs will advise directly the local authorities.

Local organisations for EP&R and PAM

Under Article 41 of the Act, the local authorities also have a responsibility in making regional/local contingency plans for emergencies. Fire fighting service, police and health services will be involved. The mayor has responsibilities to maintain public order and safety. The mayors of municipalities liable to be affected by accidents involving nuclear power plants located either within their boundaries or in their vicinity (including those across national borders) have established emergency contingency plans in consultation with representatives of central government. These plans are obligatory under Article 3 and others of the Disasters and Major Accidents Act⁷⁴, and encompass all measures that need to be taken at both local and regional levels. In more severe accidents with regional consequences, a Regional Operational Team and a Regional Policy Team is established. The Dutch Safety Region Act gives responsibilities for the regional authorities to mitigate the effects of the accident as much as possible. The national nuclear assessment team (EPAn) will provide advices for policy teams on national as well as policy teams on local or regional level to execute urgent countermeasures to protect the population and the off-site workers in the area. Exercises are held at regular intervals. With incidents with

⁷² Dutch: 'Crisis Expert Team – straling', CETs

⁷³ Nationaal Meetnet Radioactiviteit, NMR

⁷⁴ Wet rampen en zware ongevallen, Wrzo

potential consequences limited to a local or regional scale (Category-B accidents), CETs will advise the local authorities.

Intervention levels and measures

The measures that are to be taken at the various intervention levels have been listed in Table 1.

The intervention measures and levels have been established by the RB following discussions with national experts in the relevant fields. International expertise and guidelines were also taken into account. There are also derived intervention levels for foodstuffs, based on the appropriate EU regulations.

The intervention level for the protection of the public varies widely from one country to the next. However arrangements have been made with neighbouring countries to introduce matching measures in border areas, regardless of any differences in national intervention levels. Furthermore, a new harmonized approach (concerning prepreparation zones and intervention levels) in the bordering areas with Belgium (NPP Doel, Borssele NPP) and Germany (NPP Emsland) was developed and has been approved by the Minister of Economic Affairs in July 2014. Currently the new emergency planning zones are being implemented in the regional emergency plans and should be ready by the end of 2016.

Iodine tablets have been (pre)distributed to the citizens/households in the emergency planning zones of the Borssele NPP, NPP Doel (BE) and NPP Emsland (GE).

Table 1 Measures and intervention levels

Measure	Intervention level
Preventive evacuation:	1000 mSv H_{eff} (24 hours dose)
First day evacuation:	200 mSv H_{eff} (48 hours)
Late evacuation:	50-250 mSv (first year dose)
Relocation/return:	50-250 mSv (first 50 years after return)
Iodine prophylaxis:	100 mSv (child, 48 h); 1000 mSv (adult, 48 h)
Sheltering:	10 mSv H_{eff} (48 h)
Cattle grazing prohibition:	5000 Bq I-131 per m ²
Milk (products), drinking water etc:	500 Bq/l I, 1000 Bq/l Cs, 125 Bq/l Sr, 20 Bq/l alpha emitters.

Dimensions of emergency planning zones for Borssele

The planning zone covers all municipalities that are involved in the preparation, based on the reference accident-scenario for the nuclear installation. This zone has a radius of 10 km from the Borssele NPP. The mayor of Borssele coordinates the preparatory aspects of the emergency plan and the execution of measures during an accident.

It should be noted, however, that measures are coordinated at the national level in case of nuclear emergencies. Decisions will be made based on the technical information as far as available during the emergency. Emergency zoning will be established, where

countermeasures will be taken. In most cases this will be in the planning zone, but when needed it can be outside of this zone.

New emergency planning zones: HERCA WENRA approach

The policy regarding planning zones has been evaluated, taking notice of the emergency planning policies in neighbouring countries.

In case of an emergency in a neighboring country, the Netherlands will initially follow the protective actions of the accident country. In case of an emergency in the Netherlands we will base our protective actions on the Dutch policy of intervention levels. In order to do so, the planning zones will be aligned with that of the neighboring countries.

Furthermore, a scale of intervention levels is introduced. The default value within this scale is the intervention level that will be used in case of an accident with a nuclear installation in The Netherlands. In case of an incident in a neighboring country, intervention levels within the range can be used to link with the neighboring country.

Table 2 Intervention levels in mSv: default value, range and international comparison

Protective action	Intervention level (effective dose, I-prophylaxis Hth) in mSv				
	NL-new default value and range	NL-old	International ⁺	Germany	Belgium
Sheltering	10: (5-15)	10		10	5 - 15
Evacuation	100: (50-100)	200	100	100	50 - 150
I-propylaxis <18 y	50: (10-50)	100	10-50	50	10 - 50
I-propylaxis 18-40 y*	100: (50-250)	1000	WHO:100	250	50 - 100
I-propylaxe >40 y*	-	-	WHO: -	-	50 - 100

* Germany sets the age limit to 45 y

The planning zones are shown below. The borders of the zones will follow natural or administrative borders.

Table 3 Planning zones

Protective Action	HFR-Petten (NL)		HOR-Delf (NL)		KCB: (16 km)			Mol: (10,4 km)		
	old	new	old	New	NL-old	NL-new	BE	NL-old	NL-new	BE
Evacuation ⁺	-	3	-	-	5	10	10	-	-	4
Sheltering	3	3	0,5	0,5	20	10	10	-	10	10
I-predistribution	-	-	-	-	10	20	20	-	20	20
I-distribution plan**	2,1	3	-	0,5	-	100	Be	-	-	Be

Protective Action	Tihange (38 km)			Doel: (2,8 km)			Emsland: (20 km)		
	NL-old	NL-new	BE	NL-old	NL-new	BE	NL-old	NL-new	DE
Evacuation ⁺	-	10	10	4	10	10	-	10	10
Sheltering	-	10	10	40	10	10	50	10	10
I-predistribution	-	20	20	20	20	20	25	25	25
I-distribution plan**	-	100	Be	0	100	Be	-	100	100

⁺ Evacuation: the inner 5 km will be evacuated with priority.

** The I-distribution plan is to ensure that I-tablets will be available in time for those under 18 or pregnant women.

This harmonized approach has been approved by the responsible Minister in July 2014. At this moment the new emergency planning zones are being implemented in the regional emergency plans and should be ready at the end of 2016. Only after this is finished the new "harmonized approach" will supersede the current approach.

The Netherlands is actively involved in the HERCA/WENRA initiatives to harmonize the approach for nuclear and radiological accidents.

Criteria for emergency situations

Following consultation with the Ministry of the Environment and particularly with the ANVS, Borssele NPP has adopted the four classification levels in the IAEA system for use in its Emergency Plan. Each level is associated with incident/accident parameters ranging from a small fire to a large actual off-site release. Difficult elements to capture in the criteria are potential/probable consequences which have not yet occurred but which nevertheless call for larger-scale protection and prevention measures.

The specific parameters are:

1. Emergency stand-by: Emission $< 10 * \text{permitted daily emissions (noble gases; this means for the Borssele NPP } 1.3 * 10^{15} \text{ Bq Xe-133 equivalent)}$. No intervention levels are reached.
2. Plant emergency: Emission $\geq 10 * \text{permitted daily emissions (noble gases)}$. No intervention levels are reached.
3. Site emergency: Emission $\geq 0.1 * \text{accident emission (the accident emission for the Borssele NPP is defined as } \geq 3 * 10^{17} \text{ Bq Xe-133 and } \geq 5 * 10^{13} \text{ Bq I-131)}$, or an emission which leads to the lowest intervention level for indirect measures. This lowest level is a soil concentration of 5000 Bq I-131 per m^2 ; at this level a grazing prohibition must be considered. Furthermore, as the $0.1 * \text{accident emission}$ may lead to a dose level of 0.5 mSv H_{eff} or 5 mSv H_{th} in the first 24 hours after commencement of the emission, off-site measures may be considered in the form of population sheltering.
4. Off-site emergency: Emission $\geq \text{accident emission}$, being the emission that leads to the lowest intervention levels for direct measures. These lowest dose level is 10 mSv H_{eff} in the first 48 hours after commencement of the emission. At this level, population sheltering must be considered.

The emission level at which the 'Emergency stand-by' category changes to the 'Plant emergency' category (the transition point) follows directly from the permitted emission as laid down in the licence. The two other transition points depend, among other things, on the accident emission chosen. Determination of the accident emission is based on an emission of noble gases from the chimney. The reason for not using other nuclides as the trigger is that the classification on the basis of plant status will take place before a certain emission level of the nuclides has been reached; this does not apply to noble gases. In addition, a noble gas emission can be measured directly, and is therefore more suitable as a first trigger than say, an I-131 emission, which can only be measured with any degree of accuracy after a period of around an hour. The Xe-133 equivalent has been adopted as the yardstick for noble gas emission.

NCS response plan, training exercises and their organisation

Based on the lessons learned from the National Full Scale Nuclear Exercise of 2005 and 2011, the arrangements for nuclear emergency management and response were

published in 2011 and 2014. The so called National Crisis plan⁷⁵ for Radiation incidents: NCS (Dutch: 'Nationaal Crisis plan Stralingsincidenten') and the Response Plan will be updated in 2016 and in 2018 due to the implementation of the Basic Safety Standards. The National Crisisplan describes the mandates that are available to the national authorities during a nuclear accident. It also refers to other related documents that address details of the management of radiation incidents. The Response Plan describes in detail the structure and responsibilities of the various organizations involved in nuclear emergency management. It also describes the scenarios of potential nuclear and radiological accidents and measures. The key organization advising on nuclear accidents is the National Nuclear Assessment Team (EPAn), described above in this section. The NCS documents are available in Dutch only.

Based on the NCS, the Dutch training and exercise programme for nuclear emergency management and response features a four-years training- and exercise-cycle that is implemented in the annual programmes. Training is organized for different topics e.g. the use of Emergency Information and Decision Support Systems, and some exercises. A full scale exercise is planned approximately every five years. In these national exercises the interaction between generic national emergency management structures and nuclear emergency management and response are integrated.

Officials of different departments and organisations of the EPAn participate in exercises and trainings. They all have their own expertises and roles during such an exercise and during an actual accident-response. Examples of such roles are performing radiological/technical analyses, advising on health aspect, etc.

Nuclear and radiological training and exercises are both organised by the ANVS and the Minister of Infrastructure and the Environment (I&M), depending on the scale of the exercise. The Ministry of Safety and Justice is responsible for the generic national response organisation and for exercises to train this organisation. Ministries work together in the organisation of integrated large scale exercises.

16.2 Providing information to the public and neighbouring states

16.2.a Arrangements to inform the public about emergency planning and emergency situations

Chapter VI of the Nuclear Energy Act also addresses (in Article 43) the provision of information to those members of the population who might be affected by a nuclear accident. Consistent with its responsibility for managing the response to a (potential) nuclear accident, national government also is responsible for informing the public. This will be done in close cooperation with the local authorities in the threatened or affected area.

In case of a threat or emergency that needs national coordination, and needs the involvement of various ministries, the NKC, the national crisis communication centre as part of the NCC, is set up to inform the public. Experts from the various ministries will help and support the local and regional public information units based on the recently developed communication strategy for nuclear and radiological emergencies. This document will be updated in 2016. Public information about the potential risks of nuclear power plants and the existing emergency plans is provided by the municipalities (EU directive). The material needed for the information may be provided by central government, as has been the case for the municipalities in the vicinity of the Borssele and Doel NPPs, the latter being in Belgium but close to the Dutch border. The ANVS is

⁷⁵ Formerly known as National Nuclear Emergency Plan, NPK ('Nationaal Plan Kernongevallenbestrijding')

responsible for the communication to the public about the potential risks of nuclear power plants and radiation protection in general. In case of an accident the EPAn will provide the NKC with accurate information.

In addition, the governmental websites have a link to the topic of 'crises', where information can be found on numerous aspects of nuclear accidents. Another part of the site, to be open to the public only in emergency situations, contains a more comprehensive set of relevant questions and answers.

16.2.b Arrangement for informing competent authorities in neighbouring countries

The provision of information to the authorities in neighbouring countries is the subject of Memoranda of Understanding (MoU) that have been signed with bordering countries. The exchange of technical data (such as monitoring results and modelling-assessments), reports and measures takes place on a regular basis and in a response-phase between the Netherlands and Germany. With Belgium, the same approach is in preparation. Information exchange at the international level is regulated by the Early Notification Convention of the International Atomic Energy Agency and the European Commission's Decision⁷⁶ on urgent information exchange. On bilateral bases, information about (potential) nuclear or radiological emergencies will be exchanged between the respective national crises-coordination centres also.

At a national level the ANVS is, as competent regulatory authority, improving the arrangements for better and efficient information-exchange and compatibility of countermeasures with the neighbouring countries Belgium en Germany.

⁷⁶ 87/600/Euratom: Council Decision of 14 December 1987 on Community arrangements for the early exchange of information in the event of a radiological emergency

CHAPTER 2(D) SAFETY OF INSTALLATIONS

ARTICLE 17. SITING

17. Each Contracting Party shall take the appropriate steps to ensure that appropriate procedures are established and implemented:

- i. for evaluating all relevant site related factors likely to affect the safety of a nuclear installation for its projected lifetime;**
 - ii. for evaluating the likely safety impact of a proposed nuclear installation on individuals, society and the environment;**
 - iii. for re-evaluating as necessary all relevant factors referred to in subparagraphs (i) and (ii) so as to ensure the continued safety acceptability of the nuclear installation;**
 - iv. for consulting Contracting Parties in the vicinity of a proposed nuclear installation, insofar as they are likely to be affected by that installation and, upon request providing the necessary information to such Contracting Parties, in order to enable them to evaluate and make their own assessment of the likely safety impact on their own territory of the nuclear installation.**
-

17.(i) Evaluation of site-related factors

Arrangements and regulatory requirements related to siting and evaluation of sites of nuclear installations

The Acts applicable to licensing of a nuclear installation have been listed in the text on Article 7. Main examples are the Nuclear Energy Act (Kew), the Environmental Protection Act (Wm) and the General Administrative Act (Awb). Also several Decrees and Ordinances apply; they too can be found in the text on Article 7.

There are also several Nuclear Safety Rules (based on IAEA guides) that apply to the site evaluation. These are referenced in the licence of the installation, and for the Borssele NPP can be found in Appendix 4. Examples of relevant NVRs are NS-R-1 (Safety of NPPs – Design⁷⁷), NVR NS-R-3 'Site Evaluation for Nuclear Installations', and NVR NS-G-3.1 'External Human Induced Events in Site Evaluation for NPPs'. This means that the NPP needs to satisfy all requirements mentioned in these guides to maintain its licence.

Furthermore, the recently established Dutch 'Safety Guidelines'⁷⁸ (VOBK) provide, among others, guidance on siting issues for new nuclear reactors. IAEA recommendations have been incorporated, derived from various documents, like NS-R-3 'Site Evaluation for Nuclear Facilities'. Although the Safety Guidelines do not have the status of (ministerial) Regulations and do not therefore define any legal requirements, licence applications will be assessed on the basis of the safety requirements described in these Safety Guidelines. For more information on the VOBK refer to the chapter on Article 7.

⁷⁷ NS-R-1 has been superseded by the publication SSR 2/1 (Rev.1) which has the same title as its predecessor.

⁷⁸ Dutch: 'Handreiking VOBK', introduced in the present report in the section on Article 7 of the CNS.

At the time of the construction of the Borssele NPP, other rules applied to the site evaluation than today. However in the various licence applications for modifications, updates of the Safety Analyses Report and Safety Report and the associated various Periodic Safety Reviews (PSRs), appropriate attention has been given to site specific threats to the facility. For more information on PSRs refer to the section on Article 14.

The safety case of Borssele evaluates the site-related external threats from natural origin and human origin. Those from human origin may generally result from an accident in the nearby industrial environment, from pipelines, from an accident on a nearby road or railway or the river and from an aircraft crash. An example of a potential human induced hazard considered is an explosion induced by an accident with a transport of liquefied gas on the river Schelde near the site. To counter delayed ignition of a vapour cloud, an automatic detection and ignition system has been installed on the seaward side of the levee.

Hazards from natural origin considered are earthquakes, storms and other extreme weather conditions, and floods. The resulting risks for these events have been evaluated in the Probabilistic Safety Assessment (PSA) for external events and were found to be very low. Given the history and characteristics of the Netherlands, flooding is a hazard that is taken very seriously and that has been thoroughly assessed for the Borssele site. The levees near the site offer protection, and in case of flooding the calculated pressure waves will not harm the installation.

Post-Fukushima Daiichi external hazards have received increased attention, also those that may have an impact on supporting infrastructures like powerlines and access roads. In Europe activities have been coordinated by ENSREG. All EU member states have drafted National Action Plans (NACPs) that describe the status of post-Fukushima Daiichi activities. The activities related to the NACP have more or less merged with the activities that are a follow-up of the PSR. Therefore post-Fukushima Daiichi lessons learned will remain part of the continuous improvement cycle at the NPP that is embodied in the PSRs.

For more details of design provisions used against site-related external events (of human and natural origin) for the Borssele NPP, refer to the chapter on Article 18 (Design).

Currently there is the possibility that the new PALLAS research and medical isotope production reactor will be built. The 'Foundation Preparation Pallas reactor' has been established to undertake the design, procurement and licensing of a new reactor. PALLAS will be the first new-build reactor project after more than 40 years. In the licensing process siting aspects will get appropriate attention.

Regulatory review and control activities - Supervision

In the current situation there is no separate site licence or a site permit. This means that the ANVS does not have a formal oversight possibility until a construction licence is given. Review of the site related issues will be part of the SAR review for the construction license.

The ANVS supervises the implementation of measures at Borssele NPP associated with site-related factors, as decided on the basis of the PSR and the 'stress test' analysis.

17.(ii) Impact of installation on individuals, society and environment

Criteria for evaluating likely impact on population and environment and their implementation in the licensing process

Before a licence is granted, the applicant has to specify all relevant site-related factors that may affect the safety of the plant. Examples of site-related factors are events induced by human activities, such as aircraft crashes or gas cloud explosions, and events due to natural causes such as seismic phenomena and high tides. To assess the potential impact of an accident, all kind of site-related data needs to be collected, like population distribution, residence time of various population groups in the area, use of land water, meteorological statistics et cetera. These data need to be kept up to date, and in effect this is guaranteed with the cycle of PSRs.

In September 2009 the third Electricity Supply Structural Plan (SEV III ⁷⁹), became operational. SEV-III reserves space for large-scale production and transport of electricity. In SEV-III, on the basis of a preliminary selection procedure, three locations have been selected and in principle warranted for the siting of a nuclear power plant. However, the site selection process during the licensing procedure should further assess the consequences and the suitability of the site. There are no specific locations selected for other nuclear installations (not being NPPs). However, in the licensing process, the suitability of the site has to be assessed, considering potential consequences of the operation of the installation for the surrounding area.

The main site-relevant factors that have been taken into account in the preliminary selection are:

- Any special circumstances which prohibit the building of a nuclear power plant on a particular site, e.g. the presence of an airport or of industries with the potential for the release of explosive or toxic substances in the vicinity, or certain difficulties involving the existing electrical power grid;
- The population density within a radius of 20 km around the site, and especially in the most densely populated 45° sector around it. If these weighted population densities are too high compared with the weighted population densities for a reference site, the proposed site will be removed from the initial list.

17.(iii) Re-evaluating of relevant factors

Actions under the responsibility of the Licence Holder

The Licence Holder (LH) is by law bound to "continuously improvement" of the safety of the nuclear installation. This means also periodically and systematically perform safety assessments, the PSRs. The licence describes the nature of these assessments and also specifies the maximum period between them. For example, the safety of the nuclear power plant as a whole must be re-evaluated every 10 years in the light of new safety insights and generally accepted safety practices. Account must be taken of 'site-relevant factors' as mentioned in the section on Article 17.(ii). Also refer to the section on Article 14 for the PSRs.

In addition after the accident at the Fukushima Daiichi nuclear power station in 2011, the European Complementary Safety Assessment (CSA) or 'stress test' was conducted and this resulted in the NAcP mentioned before in section 17.(i). In this assessment, site related aspects have been given extra consideration. Threats like flooding and earthquakes with magnitudes of very low probability have been considered in this safety margin assessment. Also combinations of natural hazards were considered; but this was

⁷⁹Structuurschema Elektriciteitsvoorziening III

already the case in the conventional PSRs. Associated with this, the consequences of (and mitigation of) loss of infrastructure and site access have been evaluated. The post-Fukushima Daiichi lessons learned on site related hazards will remain part of the continuous improvement cycle at the NPP that is embodied in the PSRs.

Regulatory review and control activities

The RB monitors the progress of implementation of the NAcP, including those that are site-related. The PSRs are also reviewed by the RB and the process of any required action resulting from a PSR is also monitored. There are improvements that have been required by the RB.

17.(iv) Consultation with other contracting parties

The procedure for obtaining a construction licence for a nuclear installation includes an obligation to submit an Environmental Impact Assessment (EIA). As part of this procedure, neighbouring countries that could be affected by the installation are notified on the basis of the Espoo Treaty and an EU Directive:

- The Espoo Treaty of 26 February 1991. The Netherlands ratified this treaty on 28 February 1995 and the European Union ratified it on 24 June 1997; the treaty came into force in September 1997.
- Council Directive 97/11/EC of 3 March 1997, amending Directive 85/337/EEC on the assessment of the effects of certain public-sector and private-sector projects on the environment. The Espoo Treaty has been subsumed under this Council Directive.

The Netherlands has incorporated the provisions of the Espoo Treaty and the EU Directive into its Environmental Protection Act. Chapter 7 of this Act deals with environmental impact assessments and the relevant procedures. These include the provision of information to neighbouring countries and the participation of the authorities and the general public.

A special bilateral committee for nuclear installations (NDKK⁸⁰) has been set up with Germany to promote an effective exchange of information between the two countries. Originally the prime function of the NDKK (established in 1977) was to improve and guide participation by citizens (living in the proximity of the border) in the licensing procedures of the neighbouring state. Later, it assumed the additional function of a platform for the exchange of information on more general nuclear topics such as the technical aspects of installations near the border, developments in regulations and emergency preparedness activities.

A bilateral Memorandum of Understanding (MoU) of a similar nature has been agreed with Belgium.

The government is also bound by the provisions of Article 37 of the Euratom Treaty, under which all relevant data on the safety and environmental impacts of any nuclear installation that could affect a neighbouring EU Member State must be submitted to the Article 37 Expert Group before a licence can be issued by the Regulatory Body. This Expert Group advises the European Commission on the acceptability of the proposed installation on the basis of safety evaluations. The Commission thereafter informs the Member States concerned of the outcome of these evaluations.

⁸⁰ The NDKK is the Dutch-German committee for nuclear installations in the border regions.

ARTICLE 18. DESIGN AND CONSTRUCTION

18. Each Contracting Party shall take the appropriate steps to ensure that:

- i. the design and construction of a nuclear installation provides for several reliable levels and methods of protection (defence-in-depth) against the release of radioactive materials, with a view to preventing the occurrence of accidents and to mitigating their radiological consequences should they occur;**
 - ii. the technologies incorporated in the design and construction of a nuclear installation are proven by experience or qualified by testing or analysis;**
 - iii. the design of a nuclear installation allows for reliable, stable and easily manageable operation, with specific consideration of human factors and the man-machine interface.**
-

18.(i) Implementation of Defence in Depth

Overview of the Contracting Party's arrangements and regulatory requirements concerning the design and construction of nuclear installations

In the Netherlands the IAEA standards play an important role in the regulatory framework. IAEA standards are applied in amended form as NVRs. Currently the NVRs that are applicable contain the amended IAEA design requirements NVR-NS-R1 and guides NVR-NS-G-1.1 through G-1.13 and NVR 2.1.1 (classification of systems and components), an amended version of SS 50-SG-D1. Except the NVR 2.1.1, the NVR's for design have been formally introduced as licence conditions for the Borssele NPP in 2011. The NPP has to comply with these as far as reasonably achievable.

The defence-in-depth concept to be applied is defined in NVR-NS-R-1 'Safety Requirements for Nuclear Power Plant Design'. 'Defence-in-depth' is the name given to a safety philosophy consisting of a set of diverse and overlapping strategies or measures, known as 'levels of defence'. An important principle is that the means provided on one level of defence should be independent from those of other levels. This ensures that the failure of one system will not affect more than one level of defence.

Structures, Systems and Components

The identification and classification of the function and significance of structures, systems and components on safety is based on NVR 2.1.1. This Safety guide is an amended version of SS 50-SG-D1 defining four safety classes. Classes 1 to 3 are equivalent to the first three safety classes of SS 50-SG-D1. Class 4 is an extension for:

- Components whose malfunction or failure could put a demand on a safety system in case of an anticipated operational occurrence;
- Components whose malfunction or failure could lead to a significant release of radioactive materials and/or could cause a significant exposure of the site personnel or the public and for which no safety system might be provided;
- Components that may perform significant functions with respect to the prevention, termination or mitigation of anticipated operational occurrences and/or accident conditions, including severe accidents. A function is considered to be 'significant' if it ultimately improves the safety level of the plant.

For system and component design, acceptance criteria are being used based on standard engineering practices. The responsible contractor is left free to choose which specific code to use – within the restrictions of respective safety guides. The RB assesses the selected code and may formulate additional acceptance criteria. By allowing the contractor to work with a familiar code the occurrence of inadvertent errors may be reduced.

The original design and construction Safety-relevant fluid-retaining components of Borssele NPP (safety classes 1, 2 and 3, as defined by NVR 2.1.1) were designed and constructed in accordance with the earlier ASME Code, Section III, Division 1 'Code for the Operation and Maintenance of Nuclear Power Plants', the Dutch Design Code for pressure-retaining equipment, and various Siemens/KWU component specifications. In the 1990s a selection of KTA safety codes was introduced at Borssele NPP including significant additional operational experience.

Conventional electrical installations must comply with standards NEN 1010 and NEN 3410 and electrical equipment, where applicable, to NEN 3125 and NEN-EN 50.014 up to 50.020. The design codes and standards used for nuclear electrical installations are the IEEE standards and a set of KTA codes. For digital equipment the standards are used that are provided by the International Electro technical Commission (IEC), the European Committee for Electro technical Standardisation (CENELEC) and the Verband der Elektrotechnik, Elektronik und Informationstechnik e.V. (VDE).

To prevent propagation of a failure from a system classified in a lower safety class into a system classified in a higher safety class, NVR-NS-R-1 prescribes that appropriate independence must be maintained between systems or components of different safety classes. This independence can be achieved by using functional isolation and physical separation.

The Borssele NPP is a two-loop system that was built in the 1970s. Therefore, in the original design physical separation was limited. In the first 10-yearly Periodic Safety Review (PSR), a significant effort was put into creating a physical separation between redundant systems of the two loops. This separation was further improved in the second and third 10-yearly PSR. The evaluation report of the 3rd PSR was published in 2013. A number of measures resulting from this PSR have been merged with measures that resulted from the European stress test. Some of these are related to physical separation. Also refer to Appendix 5.

A selection of current developments in the regulatory framework:

- In 2014 the update of the 2009 European Nuclear Safety Directive has been published and it has to be implemented in the Dutch regulatory framework no later than August 2017. This regulation also contains binding requirements for defense-in-depth and periodic safety review. In addition the practical elimination of off-site radiological consequences for new reactors, has also to be applied to existing reactors as far as reasonably achievable. The European directive more or less covers the WENRA Objectives for new reactors and the Vienna declaration.
- In September 2014 WENRA has published its updated Reference Levels for existing reactors, based on the lessons learned from Fukushima. According to the agreement between the WENRA regulators these have to be implemented in the national framework by 2017. The expectation of WENRA is that the NPPs will probably have implemented these RLs by realization of the measures from the European Stress test, generally planned to be completed in the period till 2020. October 2015 the ANVS

published the VOBK⁸¹, the Guidelines on the Safe Design and Operation of Nuclear Reactors - Safety Guidelines for short. These Guidelines provide new reactor licence applicants with detailed insight into what the ANVS considers to be the best available technology. More details about the document can be found in the text on Article 7, in section 7.2. (i). The VOBK has been developed in preparation for the new build plans for research reactor PALLAS and plans of two other companies for two new NPPs (that were shelved in 2012). The VOBK was developed with the assistance of the German TSO GRS. The VOBK is considered to be state-of-the art, also covering the recent update of the IAEA document SSR1/2.

Status with regard to the application for all nuclear installations of the defence in depth concept, providing for multiple levels of protection of the fuel, the primary pressure boundary and the containment, with account taken of internal and external events and the impact of related sequential natural external events (e.g. tsunami caused by an earthquake, mud slide caused by heavy rain)

Currently the Borssele NPP meets the requirements regarding the defence-in-depth concept. Its compliance is summarized below:

- The first level of defence shall prevent abnormal operation and failures. Operational experience, especially as indicated by collected plant-specific component failure data, data resulting from the non-destructive testing of the primary pressure boundary, as well as the programmes for inspection, maintenance, testing, ageing etc. applied to plant systems and components, has shown that the first level of defence is adequately preserved.
- The second level of defence shall control abnormal operation and timely detect failures. In the Operational Limits and Conditions (OLC) document the limits are defined within which the Borssele NPP must operate. In order to ensure that the limits are not exceeded, the safety systems are subject to an extensive set of in service inspection, surveillance and maintenance procedures. These procedures together with the Operational Limits and Conditions document form the second level of defence.
- The third level of defence shall control accidents within the design basis. The essential means provided consist of the safety systems and other measures to control Postulated Initiating Events (PIEs) including Limiting Design Basis Events. The safety analyses that are reported in the Safety Report have to prove that the radiological consequences of design-basis events meet the radiological criteria. These radiological criteria specify smaller acceptance doses if the assumed frequency of the PIEs increases. These criteria are specified in Appendix 1.
- The fourth level of defence shall control severe plant conditions. This is realised by the symptom-based Emergency Operating Procedures (EOPs) and the Severe Accident Management Guidelines (SAMGs), that need to prevent or mitigate consequences of severe accidents should they happen despite the presence of levels 1-3.
- The fifth level of defence shall mitigate the radiological consequences of significant releases of radioactive materials in the unlikely event that they would occur. It is covered by the strategies for off-site emergency preparedness. See the section on Article 16 for more information on these strategies.

⁸¹ Dutch: Veilig Ontwerp en het veilig Bedrijven van Kernreactoren, VOBK

Safety Analysis

The Safety Report (SR) of the Borssele NPP is a two-volume document of little less than 700 pages. In this report a condensed representation is given of all safety related aspects regarding the installation and its surroundings. In addition to the Safety Report, the twenty-volume Safety Analysis Report (SAR), also known as the 'Technical Information Package' (TIP), provides extensive background information on all safety related aspects regarding the installation, plant layout and the safety analyses. The SAR also includes all details of the design base accident (DBA) analyses. The licence of Borssele NPP requires keeping the SAR/TIP up-to-date at all times.

The SAR is the starting point for all modifications and maintenance activities and is updated with each modification.

In parallel to the 3rd PSR a new SR and SAR have been developed. The SAR (TIP) will be based on the recent set IAEA safety guides.

NVR-NS-R1 (Safety Requirements for Nuclear Power Plant Design) and NVR-SSG-2 (Deterministic Safety Analysis) state that a full range of events must be postulated in order to ensure that all credible events with potential for serious consequences and significant probability have been anticipated and can be accommodated by the design base of the plant. Appendix 1 specifies the acceptance criteria for the analysis. Refer to the section on Article 14 for regulatory requirements governing the issuance of SARs (and SRs) or their updates.

For the safety analysis of the Borssele NPP, the postulated initiating events have been defined in the following categories according to their entrance probability:

- Cat. 1 Normal operation (10^{-2} - 1/reactor year);
- Cat. 1 Anticipated operational occurrences (10^{-2} - 1/reactor year);
- Cat. 2 Design Basis Accidents (10^{-4} - 10^{-2} /reactoryear);
- Cat. 3 Beyond Design Basis Accidents (10^{-6} - 10^{-4} /reactor year);
- Cat. 4 Severe Accidents ($< 10^{-6}$ /reactor year).

Further the PIEs are grouped according to the following set of threats:

- 1) Increased heat removal by the secondary cooling system
- 2) Decreased heat removal by the secondary cooling system
- 3) Decrease in flow in the primary cooling system
- 4) Pressure changes in the primary system
- 5) Inadvertent changes in reactivity and power distribution
- 6) Increase of cooling inventory in the primary system
- 7) Leakage of cooling inventory from the primary system
- 8) Radioactive releases from subsystems and components
- 9) External events (containing among others earthquakes, plane crashes, flooding and external fires)
- 10) Miscellaneous (containing among others fire and explosions inside the power plant, internal flooding of safety relevant buildings and leaks in reservoirs with highly energetic contents inside the reactor building)

In the recently overhauled and updated safety report that was used for the modification license application in 2015 there is a basic list of 81 PIEs from the original design and an additional list of 59 PIEs.

The additional list gives also more attention to events for the spent fuel pool (14 out of 59).

From the basic list of postulated initiating events, a selection has been made of a group of representative enveloping events that cover the consequences of all these events. Then for all PIEs on the additional list it is analysed if they are already covered or not. The result was that in the category 2 (DBA) three additional representative PIEs were added:

- Formation of low boron concentration areas in the primary circuit (internal deboration);
- Leakage of 20 cm² in the RPV, below the top of the core;
- Breach of a control rod case with control-rod ejection.

In the category 3 (beyond design) two representative cases of ATWS are added: emergency power and ATWS and total loss of main feedwater and ATWS. All other PIEs of this category are considered manageable with the existing provisions and additional measures taken for instance based on the stress test and PSR.

In the category 4 (severe accidents) the probabilistic safety analysis is used. This is not subject of this article.

Where it is credible that combinations of randomly occurring individual events could lead to anticipated operational occurrences or accident conditions, they are considered as a basis for the design. In the case where events occur as the consequence of other events, these events are considered as a part of the original postulated event.

Allready in the 1980s protection against external hazards was increased by bunkered safety systems and in the 1990s this was further improved. During the European stress test margins against external hazards have been evaluated. It has been concluded that these generally are sufficient and where reasonable are or will be improved. Currently the analyses for further improvements of the margins for earthquake are ongoing. The locations and level of protection for the emergency management and equipment are under discussion. Also resilience against airplane crashes is discussed. It is expected that some results can be presented at the CNS Review Meeting in 2017.

Extent of use of design principles, such as passive safety or the fail safe function, automation, physical and functional separation, redundancy and diversity, for different types and generations of nuclear installations.

The Borssele power plant takes into account a number of design principles.

The reactor design is inherently safe, through its fuel and core design (negative T-coefficient). Several passive safety provisions are available, e.g. the barrier concept to contain fission products, safety injection tanks, the design improvements like bunkered systems to protect against external events, and PARs. The fail-safe concept has been applied from the beginning. One particular example of this are the control rods that will drop into the core when electric power fails.

Redundancy and separation and were not completely established in the design stage (1970) as it should according to insights later. During the implementation of measures of the first periodic safety review (1994-1998) a lot of measures were taken to improve the situation.

Redundancy is applied for important safety systems to cope with the so called single failure criterion. For example: the low pressure safety injection and residual heat removal system has two branches (2-loop plant) and in each branch two systems. Also the

electrical system has been divided into two branches, each having an emergency diesel generator, but in addition backed up by a third DG.

Separation is applied to prevent common cause failure by for instance fire or flooding or by the effect of a failure on a neighbouring redundant system. Separation was for instance improved by moving two of the three DGs, that were all located in the same building, to a different location in a new building. Within the building they are in separated rooms with separated fuel tanks. Where relocations of redundant systems were not possible, other solutions were found; e.g. local physical separation was applied between these systems to reduce the risk of common cause failures.

The impact of common cause failures can be limited by the application of diversity. The design of the Borssele NPP incorporates diversity in several ways, such as diversity in process parameters (e.g. high pressure or high temperature) to initiate safety system actions, diversity in equipment's driving force (e.g. steam driven and motor driven emergency feed water pumps), and diversity in manufacturing (e.g. different manufacturers for 'normal' and 'bunkered' emergency feed water pumps). As a result of PSR a diverse cooling system for the reactor and fuel pool consisting of number of groundwater pumps have been installed. Stress test measures like the use of mobile equipment can also be considered as an application of diversity.

Another principle that is applied is called "leak before break".

Implementation of design measures or changes (plant modifications, backfitting) with the objective of preventing beyond design basis accidents mitigating their radiological consequences if they were to occur (this applies to the entire nuclear installation including spent fuel pools)

During the first 10-yearly Periodic Safety Review (PSR), the Borssele NPP made a thorough study on the capabilities of the installation with respect to severe accidents. Based on this study both hardware and procedural measures were taken to expand its capabilities to prevent and mitigate the consequences of a severe accident. The hardware measures involved amongst others the installation of passive hydrogen recombinators, filtered pressure relieve of the containment and filtered air supply to the control room and a separate emergency control room. The procedural measures consisted of the introduction of an extensive set of symptom-based Emergency Operating Procedures (EOPs, for prevention) and Severe Accident Management Guidelines (SAMGs for mitigation). The EOPs are based on the Westinghouse Owners Group guidelines and consist of guidelines for the Emergency Support Centre, which initiates required actions, and procedures for the control room staff. These measures were implemented in 1994-1998.

As a result of the second 10-yearly PSR further measures have been implemented like improved extinguishing agents and capability to fight large kerosene fires, the implementation of automatic pressure relieve hatches to improve natural circulation inside the containment in order to prevent too high local hydrogen concentrations and the introduction of SAMGs for non-power conditions.

Amongst others the 3rd PSR was used to verify how the NPP might comply with the new design requirements and guides introduced in 2011. Also the design of the plant is compared with the safety objectives of new reactors, published by the WENRA in 2010. In addition the stress test has been carried out. This resulted in further improvement possibilities. Examples of further improvements that have been or will be implemented till 2017 to prevent or mitigate beyond design basis accidents are:

- Increasing battery capacity on emergency grid 2

- Implementation of In Vessel Retention
- Several additional measures to refill and cool the spent fuel pool.

Implementation of particular measures to maintain, where appropriate, the integrity of the physical containment to avoid long term off-site contamination, in particular actions taken or planned to cope with natural hazards more severe than those considered in the design basis

Allready mentioned are the introduction in the 1990es of the PARs, Filtered Venting, SAMGs and in 2017 the in-vessel retention.

Improvements implemented for designs for nuclear power plants as a result of deterministic and probabilistic safety assessments made since the previous National Report; and an overview of main improvements implemented since the commissioning of the nuclear installations

In Appendix 5 details are found about modifications completed since the start of the power plant based on lessons learned and PSRs. Currently the implementation of the measures of the 3rd PSR is ongoing and will be finished in 2017. The improvements from the complementary safety review (European Stresstst) will be implemented in the same time frame, maybe with some delays till 2018. The improvements made from the 'stress test' and the progress are listed in the summary and more information on a selection of them is presented in the text on Article14.

Regulatory review and control activities

The design provisions and its modifications have to be reviewed and controlled. During the regular supervision activities elements of DiD are inspected. Special attention is given to the refueling and maintenance stop, where in particular the minimum availability of redundant safety provisions are checked frequently. Regulatory review and control start with the licensing of modifications. After the licence is granted the regulatory supervision starts. Depending on the safety importance detailed modification plans (also those that still have safety impact, but do not require a licence) have to be submitted to the regulator according to a procedure that has been approved. These plans are reviewed by the regulator possibly with support of a TSO. The plans are either rejected or agreed with or agreed without further conditions. Implementation is then supervised under the lead of the plant inspector, this could include FATs or SATs and commissioning.

18.(ii) Technology incorporated proven by experience of qualified by testing or analysis

Contracting Party's arrangements and regulatory requirements for the use of technologies proven by experience or qualified by testing or analysis

The national requirements governing proven design are based on NVR-NS-R-1. Dutch design and construction codes for pressure vessels do not contain a nuclear section. For all construction and modification activities, the LH proposes which nuclear design and construction code to use. The Dutch RB assesses the norms, standards and constructions of this code and depending on the result additional requirements are formulated. In order to ensure that the design codes used are applicable, adequate, sufficient and up-to-date only design codes have been approved that are internationally accepted, like ASME III, KTA and RCC-M.

Measures taken by the licence holders to implement proven technologies; Analysis, testing and experimental methods to qualify new technologies, such as digital instrumentation and control equipment

The safety-relevant fluid retaining components of the Borssele NPP were constructed in accordance with German material specifications. For example the steam generator tubing is made of Incoloy 800 and the control rod drive penetrations are of ferritic steel rather than Inconel 600. The 2nd PSR confirmed the low nil-ductility transition temperature of the reactor pressure vessel.

New mechanical components installed during the Modifications Project (1997), were made in accordance with the KTA design and construction rules, Siemens/KWU Konvoi component specifications (updated in 1992) and other international standards for nuclear products.

Advanced (and proven) technology was introduced with the Super Compact Tandem Safety Valves on the primary system, which were qualified by analysis, laboratory tests and test loop experiments.

The technology for the design and construction of safety systems and components for the Borssele NPP has been qualified by analysis, testing and experience in accordance with the requirements of the relevant safety regulations.

Examples are the introduction of new fuel elements, the large-scale replacement of electrical components and very recently the implementation of In Vessel Retention (realization in 2017).

Starting with the refuelling outage of 2005 new fuel elements with the improved corrosion and hydrating resisting Zirconium-Niobium cladding material M5 have been deployed. Other features of these new HTP fuel elements are the presence of a debris filter in the bottom of the fuel assembly, and new spacers to avoid grid-to-rod fretting. The M5 material had already been tested in other reactors and in laboratory experiments. The relatively high burnups of 67 MWd/tU prompted the RB to require the LH to follow the results from measurements in other plants and research facilities and report this on a yearly basis. Also for the introduction of MOX-fuel the same approach was chosen. In 2014 a first reload with lead assemblies was established.

In the 1980s, Borssele undertook a programme of partial replacement of electrical components, including instrumentation and control, in order to improve the environmental qualifications of the equipment involved. Since then, electrical components etc. in safety classes 1, 2 and 3 placed inside the containment have met the IEEE class 1E qualifications. Borssele components that must meet design-basis LOCA environmental conditions now also meet the Konvoi or VGB (Association of German Power Plant Operators) qualifications. Electrical equipment is qualified on the basis of type testing, analysis and experience. All products and services were delivered by suppliers that are either qualified by VGB or by the architect engineering company (Siemens, Framatome) under an extensive quality control programme verified by independent inspectors. Quality assurance programmes were introduced in the 1980s and resulted in the partial transfer of quality control work to suppliers. Currently the NPP has a vendor rating system.

In vessel retention (IVR) has been studied by the LH with the support of AREVA during the 10EVA13. Internationally this topic has become more important in recent years. The LH concluded that it is feasible to implement the IVR in the Borssele NPP. The ANVS requested GRS to review international experience with IVR to determine the important issues to look at and also to review the modification proposals. GRS undertook a number

of verifications, amongst others its own verification calculations and concluded that the IVR should be possible. A modification application for a retro-fit of an external cooling system for the reactor pressure vessel was filed by the LH. The modification application is currently under regulatory review. First preparatory measures in the plant were taken during the refuelling of 2016.

Regulatory review and control activities

Apart from the review of the use of proposed codes and standards, the regulatory review activities are mainly related to the scope and programmes of PSRs, licence applications, and modifications without the need for a licence application. Control activities are associated with the inspection of the correct realisation of modifications.

18.(iii) Design in relation to human factors and man-machine interface

Overview of the Contracting Party's arrangements and regulatory requirements for reliable, stable and easily manageable operation, with specific consideration of human factors and the human-machine interface (see also Article 12 of the Convention)

NVR-NS-R-1 is currently the basis for the design, as license condition. A comparable requirement as R32 from SSR2/1 can be found there. The SSR2/1 requirement 5.53 is new and not yet implemented in the regulatory framework of the Netherlands, but this is mainly applicable to a new build reactor. Borssele NPP has more than 40 years of experience in operations and the numbers of people needed. In the NVR-NS-R-1 requirement 5.56, the following additional text was included: "*For design purposes it shall be taken that any required operator action is not needed within 30 minutes after the initiating event. A shorter time shall be justified.*"

Implementation measures taken by the licence holder

The original plant was designed and constructed around 1970, when the human factor might have played a role, but to a much lesser degree than later on when new insights emerged after TMI and also from ideas implemented in modern designs. The first real PSR-type of exercise started after Tsjernobyl and led to the large modification programme in the second half of the 1990s. The modification programme undertaken at Borssele included consideration of a whole range of man-machine interface elements (also discussed in the section on Article 12). The most notable elements of the programme included the redesign of the control room, the addition of a backup emergency control room and additional local control capabilities to improve process information and controllability in all plant states, including emergency situations. Other important elements were the redesign of interlocking control processes (i.e. bridging, key-operation, and automatic blocking), tackling communication problems, evaluating and improving the accessibility (in terms of physical access and radiation doses) of systems and components during operational states and in emergency situations, and adding remote controls and indicators for safety-relevant components. As a result of the 2011 'stress test' the improvement of accessibility and operability of systems and components under severe circumstances will be implemented as a measure. For instance more remote operation and remote reading of parameters or availability of easy connectable mobile equipment are important and will be implemented.

A representative mock-up was used to optimise the design of the control room in terms of human factors. Uninterrupted sightlines, readability, communication, manageability and walking distance optimisation were all studied and the results implemented. Control room staffs were also involved in planning the layout. See Appendix 5 for a more detailed description of man-machine interface aspects at the Borssele NPP.

In addition to the Reactor Protection System (RPS) there is the Engineered Safety Features Actuation System (ESFAS) that is designed such that for all design base accidents no operator action is required during the first 30 minutes after start of the event. An exception is allowed for simple actions with clear criteria after the first 10 minutes. In addition, there is a 'limitation' system that initiates corrective actions to prevent activation of the RPS and ESFAS systems. All relevant safety related parameters are shown on a special panel, so that the operator is able to check all important safety parameters at the same time.

The design also ensures that the plant is kept in a controlled safe state during a minimum of 10 hours after an external event, without any operator actions (autarky). The autarky of the power plant will be further improved by the implementation of automatic start of the reserve emergency cooling system and reserve spent fuel pool cooling system if the normal cooling provisions are not available. By this measure the cooling of certain important systems (e.g. diesel generators) and installations (e.g. electronics) and the spent fuel is guaranteed. After the most recent PSR (10EVA13), the time that the plant can be kept in a controlled safe state after an event, without the need for off-site assistance or supply (autonomy) has for external events been expanded from 24 hours to 72 hours minimum, which is equal to that for internal events.

The introduction of the Westinghouse system of ERGs, FRGs and SAMGs in the 1990s and the further development of these, including updates after the Fukushima accident, can also be seen as a mayor improvement for the operators. Some modifications were necessary to adapt the Westinghouse system to the Siemens KWU design.

A new development in the training of workers is the building of a special building with mock-up's of some parts of the mechanical and electrical installation, where for instance maintenance activities can be simulated.

Regulatory review and control

The regulatory review activities are mainly related to the scope and programmes of PSRs, license applications and modifications without the need for a license application. Control activities are associated with the inspection of the correct realisation of modifications. The HF and MMI experts of the ANVS keep informed of relevant developments through for instance the OECD/NEA/WGHOF and also have access to knowledge of the TSO.

ARTICLE 19. OPERATION

19. Each Contracting Party shall take the appropriate steps to ensure that:

- i. the initial authorisation to operate a nuclear installation is based upon an appropriate safety analysis and a commissioning programme demonstrating that the installation, as constructed, is consistent with design and safety requirements;**
 - ii. operational limits and conditions derived from the safety analysis, tests and operational experience are defined and revised as necessary for identifying safe boundaries for operation;**
 - iii. operation, maintenance, inspection and testing of a nuclear installation are conducted in accordance with approved procedures;**
 - iv. procedures are established for responding to anticipated operational occurrences and to accidents;**
 - v. necessary engineering and technical support in all safety-related fields is available throughout the lifetime of a nuclear installation;**
 - vi. incidents significant to safety are reported in a timely manner by the holder of the relevant licence to the Regulatory Body;**
 - vii. programmes to collect and analyse operating experience are established, the results obtained and the conclusions drawn are acted upon and that existing mechanisms are used to share important experience with international bodies and with other operating organisations and regulatory bodies;**
 - viii. the generation of radioactive waste resulting from the operation of a nuclear installation is kept to the minimum practicable for the process concerned, both in activity and in volume, and any necessary treatment and storage of spent fuel and waste directly related to the operation and on the same site as that of the nuclear installation take into consideration conditioning and disposal.**
-

19.(i) Initial authorisation to operate: safety analysis and commissioning programme

It should be noted that experience with initial safety analysis and commissioning is limited, as no new nuclear power plants have been built in the Netherlands since 1973. This section is therefore related to comparable experience with:

- Periodic Safety Reviews (PSRs) of the Borssele NPP (see Article 14(i)),
- the results of inspection by international team reviews like OSART and;
- commissioning after significant changes to the installations as a result of a PSR.

As discussed in the section on Article 14(i), an in-depth safety assessment of the NPP has been made. The commissioning aspects concerning modified structures, systems and components are reviewed once the assessments have been completed.

Pursuant to NVR NS-R-2 (Safety of NPPs: Operation), the LH must set up a 'Commissioning Programme' (CP). Instructions for this task are provided by NVR NS-G-2.9 (Commissioning for NPPs). The CP has to be approved by the inspectorate of the Regulatory Body (RB), which is the ANVS. The ANVS has to assess the completeness of the programme but some parts are evaluated in detail. The findings are discussed with

the Licence Holder (LH) so that necessary changes can be made, after which the programme can be approved.

The inspectors select certain items for closer monitoring during the actual commissioning process. Audits are performed, both by the LH and by the ANVS, where necessary assisted by external experts, to ensure that the CP is being properly executed. They focus on the organisation and quality systems of both the LH and its contractors. Nevertheless, the establishment and performance of an appropriate CP remains the full responsibility of the LH.

After refuelling the reactor including all maintenance activities, the LH must submit to ANVS the results of all relevant analyses, tests, surveillances and inspections. ANVS will evaluate this information to establish whether all SCCs important to safety meet the requirements and certain criteria for reliability, before granting a restart. It should be noted that inspectors of the ANVS are present during the activities associated with refuelling and maintenance. If no deviations are found, the power plant management can decide to restart the plant. In the current philosophy of ANVS, at that stage no prior consent will be given, only if there is an issue ANVS will formally request not to restart.

The Dutch government in 2006 signed an agreement (Covenant) with the owners of the Borssele NPP, which allows for operation until the end of 2033, if requirements of the operating licence and the Covenant keep being met. More information on the Covenant can be found in Appendix 6. The LH has started a project which should demonstrate that the plant and its organisation are capable of safe operation during its anticipated operating life. This project was amongst others based on guidance provided by IAEA Safety Report Series No. 57 'Guidance for Safe Long Term Operation'. The RB initiated a set of SALTO missions (2009-2014), to support its assessments and to make sure that the scope of the LTO-programme was according to international standards.

19.(ii) Operational limits and conditions

The Borssele NPP licence states that the conditions must be described with which the systems, system components and organisation of the operation of the installation must comply, as well as the measures taken in order to operate the installation in such a way that all requirements described in the licence are satisfied. These conditions shall be approved in advance by the ANVS.

These conditions are described in the Technical Specifications (TS). The basis for these is NVR NS-G-2.2 (Operational Limits and Conditions and Operating Procedures for NPPs), but NUREG 1431 was used as a basis for their revision. The TS include the limits and conditions for operation, allowable outage times and surveillance requirements.

All deviations from the TS must be reported to the ANVS. The ANVS checks on compliance with the TS during its regular inspections.

According to NVR NS-G-2.2 the plant management has the primary responsibility of ensuring that the operational limits and conditions are complied with. To fulfil this responsibility, relevant checks and control systems have been established. All personnel holding responsibility for the implementation of operational limits and conditions are provided with the latest version of the associated documentation. There are written procedures providing for issuing and control of operational limits and conditions and their approved modifications. The operating organisation conducts audits to verify compliance with the operational limits and conditions.

The quality assurance system of the Borssele NPP requires the conditions for operation and the limits as laid down in the Technical Specifications to be observed at all times. This has priority over the economic production of electricity. NVR NS-R-2 (Safety of

NPPs: Operation) states that plant management has a direct responsibility for the safe operation of the plant. All safety-relevant management functions must be supported at the most senior level of management. In addition, the organisational structure features a special senior manager who is responsible for the independent supervision of nuclear safety, radiation protection and quality assurance at the plant. He reports directly to the CEO at the Borssele site. This ensures that safety is given a proper role in this efficiency oriented production environment.

19.(iii) Procedures for operation, maintenance, inspection and testing

The NVR NS-R-2 (Safety of NPPs: Operation) states that operation, maintenance, inspection and testing must take place in accordance with established procedures. Since the NVRs are part of the licence, the LH is bound by these conditions. The plant is operated in accordance with the instructions given in the Operating Manual, which is an extensive document describing all relevant details of plant operation. Specific instructions are given for abnormal conditions, as well as for incidents and accidents (see also the section on Article 19(iv)). These documents are approved by plant management, but are in general not submitted to the ANVS for approval. However, the Technical Specifications, major changes of the EOPs/SAMGs, the code of conduct, and the rules and regulations of the internal and the external reactor safety committee of the plant and the ISI programme have to be approved by the ANVS.

The establishment of an Internal Reactor Safety Committee (IRSC) and an External Reactor Safety Committee (ERSC) is a licence condition for Borssele NPP and the HFR research reactor. The IRSC is a reviewing body within the plant management structure to evaluate and review all matters important to nuclear safety and radiological protection. The IRSC advises and reports to the plant management and reports also to the ERSC. The ERSC is a committee under responsibility of the operating organisation to provide independent review and surveillance of the functioning of all internal safety control and safety evaluation provisions within the operating organisation such as quality assurance, IRSC, plant management and structure of the operating organisation. In addition, the ERSC may evaluate and review matters important to nuclear safety and radiological protection. The ERSC advises and reports to the operating organisation. The terms of reference, function, authority and composition of both IRSC and ERSC are subject to approval by the ANVS. The Borssele LH has described the utility management processes in relation to functions such as operation, maintenance and testing in more fundamental terms. The emphasis is on the 'key processes' of the utility organisation. Each key process describes the kind of essential processes needed, how communication between various groups and departments is to be performed and what kind of instructions and forms must be used.

The system of key processes enhances the utility's self-assessment capability. The management processes were implemented as a 'first generation' quality system in the late eighties and the system was improved in the early nineties to produce an integrated quality management system (in accordance with the IAEA codes and guides) incorporating a process-based approach. The management system comprises all the main processes in the plant: Management & Organisation, Training, Operations, Nuclear Fuel Management, Chemistry, Maintenance, Radiation Protection, Radwaste Treatment, Procurement, Configuration Management, Environmental Management, Industrial Safety, Security, Emergency Planning & Preparedness and Auditing.

The associated management procedures describe not just tasks and responsibilities, but also the input-documents (instructions, periodical programmes, checklists and specifications) to be used and the output-documents (forms and reports) to be generated.

The Operations process covers all activities in the operations field and their interfaces with other processes (like Maintenance, Chemistry and Fuel Management), for example:

- plant status control, Technical Specifications;
- work-order process, work licensing procedure;
- (functional) surveillance testing;
- surveillance rounds;
- event procedures, EOPs;
- event reporting;
- procedures for taking the plant to shut-down;
- procedures for start-up of the plant;
- temporary modifications;
- ODM;
- justification of continued operation

The Maintenance process covers all activities in the maintenance field, including interfaces with other processes (like Operations and Procurement), for example:

- preventive maintenance programmes, ISI programme, calibration & test programmes;
- ageing management;
- preparation and execution of maintenance tasks, work-order system;
- maintenance reporting.

The ANVS checks the use of instructions and forms during its regular inspections. The quality assurance system for each key process is verified during audits (carried out by the LH, the ANVS or a third party). As already stated in the text on Article 13, the quality assurance system complies with NVR-GS-R-3.

According to NVR NS-R-2 (Safety of NPPs: Operation), any non-routine operation which can be planned in advance and any test or experiment will be conducted in accordance with a prescribed procedure to be prepared, reviewed and issued in accordance with established procedures in order to ensure that no operational limit and condition is violated and no unsafe condition arises. However, should this operation nevertheless lead to an unexpected violation of one or more operational limits and conditions, standing orders shall instruct the personnel supervising or operating the controls of the plant to comply with the operational limits and conditions and consequently to bring the plant back into a safe condition. It shall be demonstrated that there is a definite need for the test or experiment and that there is no other reasonable way to obtain the required information.

Programmes and procedures for maintenance, testing, surveillance and inspection of structures, systems and components important to safety have been prepared and implemented, as a result of Periodic Safety Reviews as mentioned in Article 14. Especially the LTO programme will lead to changes in these programmes. The following main provisions in the LTO-licence are aimed at these programmes:

- requirement to adapt the organisation, procedures, administration and competences, knowledge and behaviour of the personnel with respect to ageing management
- requirement to adapt the programmes of maintenance, surveillance and inservice inspection
- amongst others the first two requirements shall be based on outcomes of the ageing management review, the evaluation of the Safety Factors "Organisation, Management System and Safety Culture" and "Human Factors" and the recommendations and suggestions of the SALTO mission of 2012.

The ANVS supervises the implementation of the requirements of the LTO-licence.

19.(iv) Procedures for response to anticipated operational occurrences and accidents

Licence Holders have to satisfy the requirements of NVR GS-G-2.1⁸² (Requirements for operation) and NVR-NS-G-2.15 (Accident Management).

The Borssele NPP has developed a comprehensive set of procedures to enable it to respond to anticipated operational occurrences and accidents. Simpler malfunctions are the subject of event-based instructions and procedures. Emergency situations are dealt with by symptom-based Emergency Operating Procedures (EOPs). Severe Accident Management Guidelines (SAMG) have been introduced. These are intended to provide guidance on accidents involving core damage and potential radioactive discharges into the environment.

The Borssele NPP LH follows the approach adopted by the Westinghouse Owners Group (WOG), both for EOPs and SAMG. The severe accident management guidance defines priorities for operator actions during the various stages of a core melt process, sets priorities for equipment repairs and establishes adequate lines of command and control. Care has been taken to tailor the WOG approach to the particular characteristics of this Siemens/KWU station. The LH has extended the existing EOPs and SAMGs with non-power procedures not available in the generic WOG package. After the Fukushima event these procedures have been extended further to be able to deal with Station Black-out during non power situations.

Both operators and other staff are given frequent training in the use of emergency operating procedures. This takes the form of courses on the full-scope simulator located in Essen, Germany, and emergency exercises at the plant. A data link for the process computer has been created between the plant and the simulator to enable calculating real time accident progression data in the phases before core melt to be monitored during an exercise by the staff at the plant. This simulator process data can also be transferred in real time to the ANVS in The Hague and to the severe accident support centres of AREVA. It is also possible to transfer the process data of the plant itself through these data links to the ANVS and to AREVA.

In the event of a severe accident, support is also available from the plant vendor, AREVA (formerly Framatome ANP and Siemens/KWU), which operates a round-the-clock service to assist affected plants and is available on call.

The supervision of safety relevant changes of important operating procedures by ANVS will be further improved starting with the procedures that will be developed or changed based on the lessons learned from Fukushima.

19.(v) Engineering and technical support

The Borssele NPP LH has built up considerable expertise and is able to manage most safety-related activities. The staff is suitably qualified and experienced as stated in Article 11.2. In addition, the LH works in close collaboration with the plant vendor and other qualified organisations in the Netherlands and abroad. Among the companies and institutions contracted are the VGB, AREVA, NRG, Tractebel, PWR owners group and AVN.

⁸² Arrangements for Preparedness for a Nuclear or Radiological Emergency

Procedures have been developed and implemented for contractors. For instance, contractors are made familiar with the installation and normal working procedures by showing them training films explaining 'work practices'.

The supervision of ANVS on the subject of qualification of technical support organisations for the LH has been limited mainly to the contractors acting on site during refueling or modifications.

The ANVS frequently uses TSO support for its assessments and inspections. For more information on the organisation of contracted support for the ANVS, refer to the text on Article 8 'Regulatory Body', and more specifically section 8.1.k.

The ANVS also benefits from input from the EU Clearinghouse for the evaluation of incidents. One of the predecessors of ANVS is one of the founding partners of the EU Clearinghouse.

The German phase-out will reduce the possibilities for both operator as well as ANVS to contract support from German companies and institutes. The post-Fukushima National Action Plan addresses this issue. Refer to the text on Article 8 for more information (specifically section 8.1.j, 'Future and current challenges for the Regulatory Body').

For current staffing at the RB, refer to the text on Article 8.

19.(vi) Reporting of incidents

An incident-reporting system is a condition of the licence and is in operation for all existing nuclear installations. The system is based NVR NS-G-2.11, 'A System for the Feedback of Experience from Events in Nuclear Installations'.

The criteria for reporting to the regulatory authorities are described in the Technical Specifications. Depending on its nature, an event must be reported to the ANVS:

- category (a) events have to be reported within eight hours by telephone and within 14 days by letter, or
- category (b) events have to be reported within 30 days by letter (this type of incident is normally also reported the same day by telephone).

Examples of category (a) events are:

Violations of the licence and the Technical Specifications limits, exposure to high doses (as referred to in the Bkse), activation of the reactor protection system leading to reactor scram, ECCS actuation and/or start of the emergency power supply (diesel generators).

Examples of category (b) events are:

- (Minor) leakages of fuel elements, leakage of steam generator tubes and of the primary system, non-spurious activation of the reactor protection system and events causing plant staff to receive a dose in excess of 10 mSv.
- Degradation of safety systems or components, and events induced by human activities or natural causes that could affect the safe operation of the plant.

In exceptional situations, i.e. if there is a major release of radioactive material or if a specified accident occurs (> 2 on the International Nuclear Event Scale, INES), the NPP is obliged to notify the National Emergency Centre directly. Depending on the nature of the accident, various government bodies are alerted. The ANVS is always alerted. Further information is given in the section on Article 16.

The ANVS houses the national officer for INES (International Nuclear Event Scale) and also the national coordinator IRS (Incident Reporting System) and IRSRR (Incident Reporting System for Research Reactors). Also ANVS is responsible for the newer

systems like FINAS and the NEA system for the collection of events during construction of a new nuclear installation.

Reports from the LH are first handled by the ANVS inspector on duty. The inspector prepares, if necessary supported by colleagues, a first action or reaction to the LH. Next ANVS experts work further on the report and take the suitable actions like requiring further action from the LH, international reporting and determining the INES scaling. ANVS prepares an annual report on nuclear incidents to the Dutch Parliament and monitors the progress made by the LHs on the follow-up of incidents.

19.(vii) Sharing of important experience

Power plant (Borssele)

A standing task force at the nuclear power plant assesses incidents. The establishment of this task force is required under the licence. A second standing task force assesses ageing issues. It is recognised that the effects of ageing may pose technical challenges in the future, and that expertise and adequate data on operational history need to be available to cope with these potential problems. The LH of the NPP operates databases for its own use and these contain data on incidents from various sources, including the plant itself, WANO, IAEA and OECD/NEA IRS, IAEA News, VGB, AREVA, USNRC, GRS, etc.

Borssele reports relevant incidents to WANO and VGB. Operational measures obtained from WANO (Good Practices and Performance Objectives & Criteria) are implemented by Borssele NPP.

Information is regularly exchanged on a bilateral basis with operators in neighbouring countries, plus a number of other countries. Personnel of Borssele actively participates in WANO-, OSART-, AMAT- and other missions at foreign NPPs.

Research reactors and fuel cycle facilities (uranium enrichment and nuclear waste storage)

These facilities have organisational structures and expertise to share important experience between facilities. All of them have standing task forces for the assessment of incidents.

All facilities have specific international contacts within their scope of work.

The Regulatory Body

There are frequent regulatory contacts with many European countries and the USA. Within the framework of the NEA, the Netherlands participates in a working group dealing on a regular basis with operational events. The Netherlands are a member of the OECD/NEA and IAEA mechanisms for sharing key operational experience, the Working Group on Operational Experience (WGOE) of the OECD/NEA Committee for the Safety of Nuclear Installations (CSNI), and the international incident reporting systems (IAEA and OECD/NEA IRS, IRSRR and FINAS). Further the Netherlands are a member of the EU Clearing House. Since 2013 ANVS has close relations with RBs in countries that like Germany have one or more operating Siemens/KWU plants (KWUREG club): Brazil, Switzerland and Spain.

The ANVS closely monitors the lessons learned from the Fukushima Daiichi accident (special project created). The ANVS also contributed to the NEA/CNRA Special Task Group Fukushima Lessons Learned. It also participates in international expert teams for nuclear topics. A recent example is the participation in international review teams related to the Doel-issue (flaws in reactor vessel).

According to a 2014 IRRS recommendation the ANVS has to improve the OEF and REF to make a more structured approach according to international standards. In 2015 the ANVS collected a lot of information about OEF practices in other countries, including hosting a IAEA Workshop end of 2015. In 2016 a project has started to implement the recommendations.

According to a recent modification of the Nuclear Energy Act, ANVS has to intensify the reporting and informing about incidents in neighbouring countries.

19.(viii) Generation and storage of radioactive waste

The licence for the NPP states that the provisions of the NVRs must be satisfied. On the issue of radioactive waste management, NVR NS-R-1 (Safety of NPPs: Design) requires adequate systems to be in place for handling radioactive solid or concentrated waste and for storing this for a reasonable period of time on the site. The LH has such systems at its disposal and keeps records of all radioactive waste materials, specifying the type of material and the form of packaging.

The Dodewaard NPP has sent all fuel for reprocessing at Sellafield and has sent all easy removable waste to COVRA. The plant has been transformed into a safe enclosure. This building will contain the remaining materials for 40 years (until 2046) in order to minimise both the activity and the volume of the waste eventually to be transported to COVRA.

The LH of the Borssele NPP has adopted a written policy of keeping the generation of radioactive waste to the minimum practicable. One of the measures taken to this end is ensuring that the chemistry of the primary system is adequate, in order to reduce the generation of corrosion particles which may be activated. Internal procedures are used to achieve optimum water quality.

Solid waste from the site is transported in accordance with conditions set by the RB. Under these conditions, the LHs have to draw up a timetable for the transportation of radioactive waste to the COVRA interim storage facility for all radioactive waste produced in the Netherlands. The LHs must send a list to the ANVS at the beginning of each year, stating how much radioactive waste is in storage on-site and how much waste has been transported to COVRA over the previous year.

The NPP's waste management programmes stipulate that general internal radiation protection procedures must be observed so as to satisfy the radiation protection principles, as well as NVR NS-G-2.7 (Radiation Protection and Radioactive Waste Management in the Operation of NPPs). The latter includes the treatment and storage of spent fuel and waste directly related to operation (taking conditioning and disposal into account). The ANVS is informed, as described in the section on Article 15.1.

Spent fuel from the Borssele NPP is reprocessed and the resulting waste components and the vitrified waste are stored at COVRA. Borssele recycles its Plutonium through the use of MOX-fuel.

Appendix 1 SAFETY POLICY AND SAFETY OBJECTIVES IN THE NETHERLANDS

a. Safety objectives in a historic perspective

In the Netherlands, safety policy in the nuclear field was originally based on the following overarching fundamental safety objectives:

The general nuclear safety objective:

To protect individuals, society and the environment from harm by establishing and maintaining in nuclear installations effective defences against radiological hazards.

The general nuclear safety objective is supported by two complementary safety objectives:

The technical safety objective:

To take all reasonably practicable measures to prevent accidents in nuclear installations and to mitigate their consequences should they occur; to ensure with a high level of confidence that, for all possible accidents taken into account in the design of the installation, including those of very low probability, any radiological consequences would be minor and below prescribed limits; and to ensure that the likelihood of accidents with serious radiological consequences is extremely low.

The radiological safety objective:

To ensure that in all operational states radiation exposure within the installation or due to any planned release of radioactive material from the installation is kept below prescribed limits and as low as reasonably achievable, and to ensure mitigation of the radiological consequences of any accidents.

a.1. Technical safety objective

As discussed in the sections on the various articles of the Convention, extensive rules and regulations, derived from the IAEA Safety Standards, have been defined and formally established. No licence is issued unless the applicant satisfies the regulations. Inspections are carried out to monitor compliance with the rules. Priority is given to safety, and the Licence Holder (LH) is aware of its responsibility for safety. Periodical Safety Reviews (PSRs) are conducted, to ensure that account is taken of new safety insights.

The Dutch Regulatory Body (ANVS) therefore believes that all echelons of the defence-in-depth principle have been preserved, so that there is a low probability of accidents and, should accidents occur, the probability of radiological releases is very low. Even in the case of accidents beyond the design basis – those that might lead to serious radiological releases – measures have been taken to further reduce their probability and to mitigate the consequences should they occur. The follow up of the 'stress test' includes measures that will further increase the safety margins.

In the light of these measures, the technical safety objective has been fulfilled.

a.2. Radiological safety objective

Under the radiological safety objective, the formal legal limit for the radiation levels to which members of the public are exposed is based on the Euratom 1996 Basic Safety

Standards. Since the 2013 there is an updated Basic Safety Standard, that is now being implemented. The government has also formulated an environmental risk policy, which has to be taken into account. Refer to next section b.

These objectives had been adopted from the IAEA report entitled 'The Safety of Nuclear Installations – Safety Fundamentals', Safety Series No 110. Since 2006, this document has been superseded by SF-1, 'Fundamental Safety Principles' of the IAEA Safety Standards Series. There is no principle difference with the above objectives in SF-1. In June 2014 the Netherlands has published the document "Outlines of the Dutch policy for radiation protection and nuclear safety".

Refer to section **c** of this Appendix for ongoing regulatory developments that will properly embed SF-1 in the regulatory framework.

b. Dutch environmental risk policy

The concept of risk management and risk assessment was first introduced into Dutch environmental policy in the 1986-1990 Long-Term Programme for Environmental Management. The concept was reassessed following debates in Parliament. As part of the Dutch National Environmental Policy Plan⁸³, the government set out a revised risk management policy in a document called 'Premises for Risk Management; Risk Limits in the Context of Environmental Policy'⁸⁴. Next, a separate document was issued dealing with the risk associated with radiation: 'Radiation Protection and Risk Management; Dutch Policy on the Protection of the Public and Workers against Ionising Radiation'⁸⁵. These documents still constitute the basis for government policy on risk management.

The Nuclear Installations, Fissionable Materials and Ores Decree (Bkse) has been amended to incorporate this risk policy in the licensing process for nuclear installations. Risk criteria are explicitly included as assessment principles for licences to be granted to nuclear power plants. The outcomes of a level-3 PSA must be compared with these risk criteria and objectives.

This concept of environmental risk management incorporates the following objectives and steps:

- verifying that pre-set criteria and objectives for individual and societal risk have been met. This includes identifying, quantifying and assessing the risk;
- reducing the risk, where feasible, until an optimum level is reached (i.e. based on the ALARA principle);
- maintaining the risk at this optimum level.

Normal operation

The dose limit due to normal operation of installations consists of a maximum total individual dose of 1 mSv in any given year for the consequences of all anthropogenic sources of ionising radiation (i.e. NPPs, isotope laboratories, sealed sources, X-ray machines, etc). For a single source, the maximum individual dose has been set at 0.1 mSv per annum. In addition, as a first step in the ALARA process, a general dose constraint for any single source has been prescribed at 0.04 mSv per annum.

Design-basis accidents

Design-basis accidents (DBAs) are postulated to encompass a whole range of related possible initiating events that can challenge the plant in a similar way. These individual

⁸³ Lower House of the States General, 1988-1989 session, 21137, Nos. 1-2, The Hague 1989

⁸⁴ Lower House of the States General, 1988-1989 session, 21137, No. 5, The Hague 1989

⁸⁵ Lower House of the States General, 1989-1990 session, 21483, No. 1, The Hague 1990

related initiating events do not therefore need to be analysed separately.

With DBAs it is easy to introduce the required conservatism. With a probabilistic approach, uncertainty analyses need to be performed to calculate confidence levels.

By definition, DBAs are events that are controlled successfully by the engineered safety features. Hence, they do not result in core melt scenarios, and are considered in a PSA as being 'success sequences'. The related radioactive releases are negligible compared with the uncontrolled large releases associated with some of the beyond-design-basis accidents. In other words, a general 'state-of-the-art' PSA, which focuses primarily on core melt scenarios and associated large off-site releases, does not take account of the consequences of DBAs.

Clearly, the above dose and risk criteria are not suitable for use as rigid criteria in the conservative and deterministic approach used in traditional accident analyses. A separate set of safety criteria has therefore been formulated, as required by NVR NS-R-1⁸⁶. The set of criteria is defined in the Nuclear Installations, Fissionable Materials and Ores Decree (Bkse, refer to text on Article 7 of the CNS). The criteria are:

Frequency of event F per annum	Effective dose (H_{eff} , 50 years) in mSv	
	Adult	Child
$F \geq 10^{-1}$	0.1	0.04
$10^{-1} > F \geq 10^{-2}$	1	0.4
$10^{-2} > F \geq 10^{-4}$	10	4
$F < 10^{-4}$	100	40

An additional limit of 500 mSv thyroid dose (H_{th}) must be observed in all cases.

Correspondingly the provisions concerning the dose related to normal operation as a first step in the ALARA process, a general dose constraint has been prescribed at values of 40% of the above mentioned.

Severe accidents

As far as severe accidents are concerned, both the individual mortality risk and the group risk (= societal risk) must be taken into account.

The maximum permissible level for the individual mortality risk (i.e. acute and/or late death) has been set at 10^{-5} per annum for all sources together and 10^{-6} per annum for a single source.

In order to avoid large-scale disruptions to society, the probability of an accident in which at least 10 people suffer acute death is restricted to a level of 10^{-5} per annum. If the number of fatalities increases by a factor of n , the probability should decrease by a factor of n^2 . Acute death means death within a few weeks; long-term effects are not included in the group risk.

To demonstrate compliance with the risk criteria direct measures such as evacuation, iodine prophylaxis and sheltering are not taken into account.

This risk management concept is used in licensing procedures for nuclear installations.

For NPPs the level-3 PSA plays a leading role in the verification process. Specific procedural guidelines have therefore been drafted in the Netherlands for the conduct of full-scope PSAs. The level-1 PSA guide is an amended version of the IAEA SSG-3

⁸⁶ NVR NS-R-1 'Veiligheid van kernenergiecentrales: veiligheidseisen voor het ontwerp', which is an adaptation of IAEA Safety Requirements Safety Standard Series No. NS-R-1, 'Safety of Nuclear Power Plants: Design Safety Requirements'.

'Development and Application of Level 1 Probabilistic Safety Assessment for NPPs' and the level-2 guide is based on IAEA SSG-4 'Development and Application of Level 2 Probabilistic Safety Assessment for NPPs'.

The procedural guide for level-3 PSAs is a specifically Dutch initiative, in which the COSYMA code for atmospheric dispersion and deposition is used. It gives instructions on the pathways which have to be considered, the individuals (i.e. critical groups) for whom the risks should be assessed and the type of calculations which should be performed. It also describes how the results should be presented.

Since it has been recognised that PSAs produce figures that can be used as a yardstick in safety decisions, a number of countries have developed probabilistic safety criteria. The ANVS has taken note of the INSAG-3 safety objective, i.e. the maximum acceptable frequency for core damage currently is 10^{-5} per annum for new NPPs and 10^{-4} per annum for existing NPPs. In the meantime in the Netherlands these values have evolved to lower values (refer to section d).

In addition, the objective of accident management strategies should be that the majority of potential accident releases will not require any immediate off-site action, such as sheltering, iodine prophylaxis or evacuation. This means that the dose to which members of the public are exposed in the first 48 hours after the start of the release should not exceed 10 mSv. The PSA helps to employ measures as effectively as possible.

c. Continuous improvement

The Netherlands has brought Council Directive 2009/71/EURATOM of 25 June 2009 on nuclear safety into force⁸⁷ on July 22, 2011. The safety objectives of the Directive cover those of the Convention on Nuclear Safety and are in some regards more specific and have a larger scope. The regulation asks for the continuous improvement of safety.

The Directive refers to amongst others to IAEA SF-1 for its appropriate implementation by the member states. The Netherlands thus formally complies with the principles of SF-1.

The updated nuclear safety directive 2014/87/Euratom is at present being transposed into Dutch regulations.

d. Regulatory developments

In October 2015 the ANVS published the VOBK⁸⁸, the Guidelines on the Safe Design and Operation of Nuclear Reactors - Safety Guidelines for short. These Guidelines provide new (light water) reactor licence applicants with detailed insight into what the ANVS considers to be the best available technology.

It consists of an (extensive) introductory part and a technical part, the 'Dutch Safety Requirements', de DSR. Refer to the text on article 7 for more details on the VOBK. The VOBK is non-binding as such – so at the same level as the NVRs and IAEA standards. An incentive for its development were earlier plans for nuclear new build. The DSR provides for clear requirements for up-to-date requirements for NPPs and research reactors, in line with a graded approach, covering the lifetime of the plant.

⁸⁷ Regulation of the Minister of Economic Affairs, Agriculture (EL&I) and Innovation and the Minister of Social Affairs and Labour of 18 July 2011, No WJZ/11014550, concerning the implementation of Directive No 2009/71/Euratom of the Council of the European Union 25 June 2009 establishing a Community framework for nuclear safety of nuclear installations (PB EU L 172/18).

⁸⁸ Dutch: Veilig Ontwerp en het veilig Bedrijven van Kernreactoren, VOBK

The DSR focusses mainly on technical requirements. Requirements for management and organisation (M&O) will be developed separately.

The DSR are based on the latest insights regarding the safety of new nuclear reactors. Specifically, the latest design and operating recommendations made by the IAEA and the WENRA have been incorporated. The Finnish regulations were also referred to in connection with various matters in the field of new facility construction. Finally, the IAEA lessons learned from the Fukushima accident are reflected in the DSR.

The IAEA recommendations are derived from various documents, such as SF-1 Fundamental Safety Principles, Specific Safety Requirements 2/1 and 2/2, NS-R-3 Site Evaluation for Nuclear Facilities and NS-R-4 Safety of Research Reactors. The lessons learned from the Fukushima accident are identified in the IAEA's document DS 462, which were incorporated in revised versions of 5 IAEA Requirements documents

Those lessons include the need for improved readiness for natural disasters. The DSR now require licence applicants to take explicit account of possible combinations of natural disasters and the impact of natural disasters, both on the safety systems within the facility itself and on the surrounding infrastructure. In addition, the possibility of 'cliff-edge effects' and the scope for building greater safety margins into the design shall be investigated.

The technical requirements part of the DSR has seven main chapters and six annexes. The most important chapters of the technical DSR are the chapters 2 and 3. The structure and content of the DSR is explained below to some detail.

Ch 1 Fundamental principles

The fundamental safety objective is to protect people and the environment from harmful effects of ionising radiation throughout the entire lifetime of a nuclear reactor: design, construction, commissioning, operation, decommissioning and dismantling. Safety measures, security measures and measures for accounting for, and control of, nuclear material shall be designed and implemented in an integrated manner in such a way that they do not compromise one another.

Ch 2 Technical safety concept

The safety objectives for new power reactors recommended by the Western European Nuclear Regulators Association (WENRA) have been implemented in the technical safety concept. Refer to Table 4 of the present CNS-report for an overview of the technical safety concept. Also some preliminary lessons learned after Fukushima have been incorporated; future lessons will be incorporated in succeeding updates. Chapter 2 of the DSR addresses five main topics:

- Concept of 'Defence in Depth' (DiD), with levels of defence 1, 2, 3a, 3b, 4 and 5 (refer to Table 4). The levels of defence shall be independent as far as practicable.
- Concept of multi-level confinement of radioactive inventory, with barriers and retention functions and their links to the various levels of defence.
- Concept of fundamental safety functions; reactivity control, core cooling and confinement of radioactive materials. For all levels of defence, the DSR describes the requirements that need to be fulfilled in relation to these safety functions – where applicable.
- Concept of Protection against internal and external events. There shall be no failure of safety systems due to external events. With internal hazards, only the affected systems are allowed to fail. Combinations of hazards shall be taken into account.

- Radiological safety objectives that have to be complied with. The DSR requires that large releases shall be practically eliminated. Only limited (in area and time) protective measures shall be needed at DiD level 4.

Implementation of the technical safety concept results in practical elimination of phenomena leading to large and early releases (level of defence 4).

Figure 3 shows the anticipated position of the DSR in the regulatory framework.

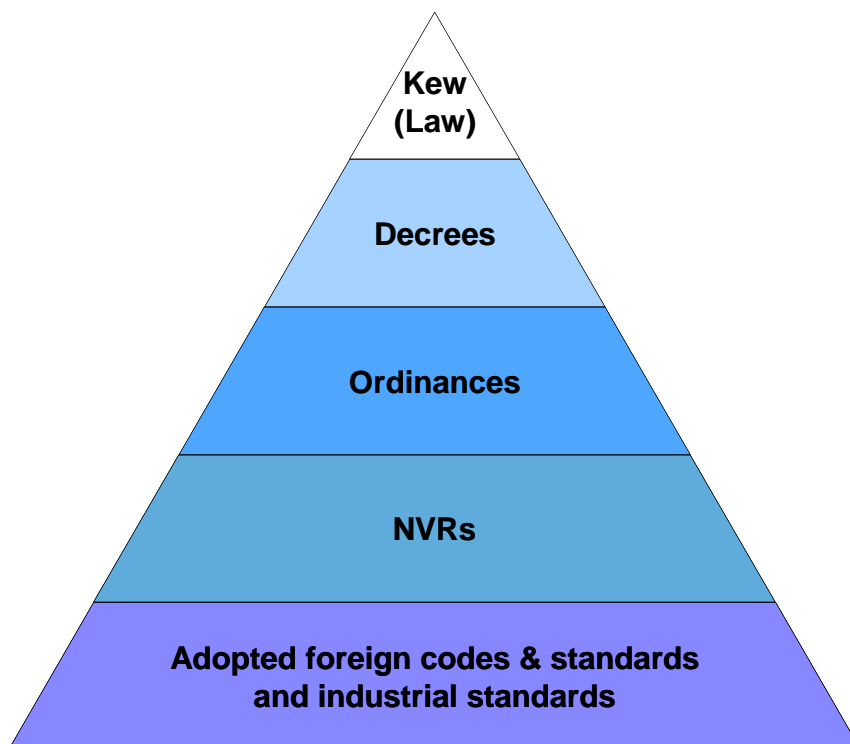

Figure 3 The anticipated position of the DSR in the regulatory framework will be at the level of the NVRs

Ch 3 Technical requirements

Chapter 3 of the DSR details the technical requirements that when fulfilled will contribute to implementing technical safety concept of chapter 2 of the DSR. Chapter 3 lists many requirements for among others design of the reactor core and shut down systems, fuel cooling in the core, reactor coolant pressure boundary, buildings, containment system, I&C, control rooms etcetera.

Various requirements have been stepped up in comparison to current requirements, like those for redundancy.

Ch 4 Postulated operating conditions and events

A plant specific list of events has to be created. Chapter 4 of the DSR outlines

what kind of events need to be considered in relation to the various DiD levels. It also addresses events involving multiple failure of safety installations. In chapter 4 of the DSR, also reference is made to the annex-1 of the DSR with postulated events that as a minimum need to be considered.

Ch 5 Requirements for the safety demonstration

Chapter 5 of the DSR details the requirements for the 'safety demonstration' (safety case). The safety case, to be documenten in a Safety Analysis Report (SAR) shall cover all phases during the lifetime of the plant. Reference is made to IAEA Safety Standards for specifications for the SAR. Deterministic as well as probabilistic analysis (including level-3) are required for the safety case.

Ch 6 Requirements for the operating rules

Chapter 6 of the DSR details what kind of information shall be documented for the operating rules. More specific specifications are given in annex-4 of the DSR. The DSR also details requirements regarding accessibility of documentation, updating of documents and associated procedures.

Ch 7 Requirements for the documentation

This chapter states that "*The licensee shall have available a systematic, complete, qualified and upto-date documentation of the condition of the nuclear power plant.*". For details the DSR refers to its annex-4.

Table 4 Technical safety concept in DSR, based on WENRA guidance

Levels of defence in depth	Associated plant condition categories	Objective	Essential means	Radiological consequences
Level 1	Normal operation	Prevention of abnormal operation and failures	Conservative design and high quality in construction and operation, control of main plant parameters inside defined limits	Regulatory operating limits for discharge
Level 2	Anticipated operational occurrences	Control of abnormal operation and failures	Control and limiting systems and other surveillance features	
Level 3 ¹	Level 3.a Postulated single initiating events	Control of accident to limit radiological releases and prevent escalation to core melt conditions ²	Reactor protection system, safety systems, accident procedures	No off-site radiological impact or only minor radiological impact
	Level 3.b Postulated multiple failure events		Additional safety features, accident procedures	
Level 4	Postulated core melt accidents (short and long term)	Control of accidents with core melt to limit off-site releases	Complementary safety features to mitigate core melt, Management of accidents with core melt (severe accidents)	Limited protective measures in area and time
Level 5	-	Mitigation of radiological consequences of significant releases of radioactive material	Off-site emergency response Intervention levels	Off-site radiological impact necessitating protective measures

The DSR has six annexes, of which annex-6 is dedicated to requirements for Research Reactors:

Annex 1: Postulated events

This annex to the DSR defines events assigned to the levels of defence 2 to. It presents generic event lists for pressurized water reactors (PWRs) and boiling water reactors (BWRs), as well as for spent fuel pools. Especially for these events it shall be demonstrated in accordance with the "Annex 4: Requirements for the safety demonstration and documentation" that the safety-related acceptance targets and acceptance criteria applicable on the different levels of defence in depth are achieved and maintained.

Annex 2: Requirements for provisions and protection against hazards

This annex to the DSR-document, provides additional requirements to the design in providing protection against internal and external hazards.

Annex 3: Basic principles of the application of the single failure criterion and

for maintenance

This annex to the DSR document provides requirements regarding the application of the single failure concept and requirements for maintenance. Notable requirements are:

- (n+1) for I&C on level of defence 2;
- (n+2) level of defence 3a;
- (n+1) for active parts on level of defence 3b and 4 according to WENRA / RHWG.

Annex 4: Requirements on the safety demonstration and documentation

This annex to the DSR-document, provides additional requirements regarding the safety demonstration and associated documentation.

Annex 5: Definitions

Annex 6: Requirements for research reactors

Annex 6 provides guidance for the appropriate application of the DSR to research reactors:

- Description of the systematic approach of the method;
- Matrix of all requirements of the 'Safety Requirements for Nuclear Reactors' and proposal of appropriate application.

Each research reactor is unique and will have to be individually regulated. The annex present a systematic approach to categorization of the research reactor according to the specific hazard potential.

Also a generic event list for research reactors is presented.

Appendix 2 THE ROLE OF PSAs IN ASSESSING SAFETY

a. History of the role of PSAs and their role in the Netherlands

As long as a PSA is comprehensive in its scope (including shut-down states, internal and external events, etc.) and is state-of-the-art, it will be an instrument that can be used to roughly demonstrate compliance with safety criteria, thereby recognising the uncertainty and imponderability of a large number of relevant matters. In that way it can be used as a decision-making tool, without the need for an absolute belief in the numbers yielded.

Dutch nuclear power plants (NPPs) launched their PSA programmes in 1989. The main objective was to identify and assess relatively weak points in the design and operation of the power plants, and thus to facilitate the design of accident management measures and to support back-fitting. An assessment of source terms, public health risks, etc., was regarded as unnecessary at that time.

Major modification and back-fitting programmes were announced at around the same time, partly as a result of the accident at Chernobyl. A back-fitting requirement or 'rule' was formulated for the existing NPPs. The requirement addresses the design-basis area, but also the beyond-design-basis area and associated severe accident issues. The 'back-fitting rule' also requires 10-yearly safety reviews. This requirement was included in the operating licences issued for both plants. At that time an important part of these 10-yearly safety reviews was a level-1 'plus' PSA (level 1+).

In the early 1990s, these level-1+ PSAs were expanded to full-scope level-3 PSAs, including internal and external events, power and non-power plant operating states, and human errors of omission and commission. The PSAs were expanded partly in order to comply with the requirement that the studies should be 'state-of-the-art' (i.e. including non-power plant operating states and human errors of commission), and partly because of the licensing requirements associated with the ongoing modification programmes (i.e. an environmental impact assessment had to include a level-3 PSA).

b. Guidance for and review of the PSAs

Establishing guidelines for PSA

At the start of the Dutch PSA programmes in 1988/1989, there were no national PSA guidelines. In addition, both the Licence Holders (LHs) and the Regulatory Body had very little experience in developing a complete PSA for a nuclear power plant. For this reason, both the LHs asked foreign contractors to develop their PSAs and at the same time transfer knowledge. Mainly regulatory guidance from the USA was used at that time. The development was further accompanied by a series of IAEA missions. In the early 1990s, in a combined effort, Dutch institutes produced PSA-3 guidelines.

Since the shutdown of the Dodewaard NPP in 1997, the only NPP in operation is the Borssele NPP.

Currently these guidelines are being updated in the light of amongst others developments in national regulations (e.g. DSR), dispersion models and dose calculation methods. For instance attention is being given to lift off of the plume and the influence of buildings. Overall conclusion so far: more insights have been gained, although the existing methods are still good enough. The new guidelines will not result in significant changes in the way PSA-3 calculations are performed in The Netherlands.

c. Living PSA applications

After the PSA relating to the 1994 modification project had been completed, the focus shifted towards Living PSA (LPSA) applications. The licence of 1994 for the modified Borssele plant required the LH to have an operational Living PSA.

Currently, the PSA for the Borssele NPP is updated yearly. This means that both plant modifications and updated failure data are included in the PSA model. The operator, EPZ, is using the Living PSA for many applications:

- Evaluation of modification proposals (design review);
- Licensing support;
- Technical Specification optimisation (pilot);
- Optimisation of the maintenance programme;
- Optimisation of periodic testing and surveillance;
- Shut-down period configuration evaluation and optimisation;
- Day-to-day configuration evaluation and optimization;
- Event analysis;
- Development of Severe Accident Management Guidelines (SAMGs);
- Use of PSA source terms for emergency planning & preparedness.

Below a number of the applications are explained to some detail.

Evaluation of modification proposals (design review)

In 1993 the first 10-yearly Periodic Safety Review (PSR) took place. The PSR resulted in a major modification program. Although the PSA was not yet finalised, it was felt that the PSA could play a large role in the optimisation and evaluation of the deterministic safety concept, the study of alternative solutions and in the licence renewal (Environmental Impact Assessment).

The established modifications reduced the TCDF from $5.6 \cdot 10^{-5}$ /year to $2.8 \cdot 10^{-6}$ /year.

In 2003 the second PSR took place. The PSA played an important role in this PSR. All issues were weighed against deterministic criteria (Low, Medium and High impact) and the risk significance (TCDF and Individual Risk (IR)).

Technical Specification optimisation

Borssele NPP has done a pilot to optimize the Allowed Outage Times (AOTs) and inspection intervals. US-NRC Regulatory Guide 1.177 was used as the base for the application, amended to reflect the situation in the Netherlands. The Borssele NPP has modified the acceptance criteria from this guide by lowering them with a factor of 10.

Other boundary values that have been used in the application include:

- For optimisation of AOTs the LH has adopted a value of $5 \cdot 10^{-8}$ for $\Delta\text{TCDF} \times \text{AOT}$
- TCDF shall always $< 1 \cdot 10^{-4}$ /year.

Apart from the PSA an expert team participated in the project to address deterministic views, like preservation of defence in depth and safety margins. The team also took into account items like necessary maintenance and repair times, adequacy of spare parts, availability and duration of supply of components on the market.

Shut-down period configuration optimisation (use of risk monitor)

In the figure below an example is given of the result of the outage planning for the refuelling outage in 2004.

One of the main objectives for the use of the risk monitor for configuration control is to minimise the TCDF increase as a result from planned component outages by:

- Mastering simultaneous component outages
- Rescheduling component outages with high TCDF impact in a certain plant operating state to an operating state where the component outage has a lower impact,
- Reduction of duration of the refuelling outage.

As a decision yardstick several numerical criteria have been developed by the LH:

- Cumulative TCDF increase caused by planned and unplanned component outages < 5%
- Cumulative TCDF increase caused by planned component outages < 2 %.
- Instantaneous TCDF shall never exceed the value of $1 \cdot 10^{-4}$ / year.

Day-to-day configuration evaluation

This application of LPSA must be stressed. The Borssele NPP is equipped with a high redundancy level. In many cases where a component is taken out of service, the technical specification AOT is not entered. In this area, the use of PSA is very useful. The cumulative delta-TCDF is used as a special performance indicator for this. EPZ aims to keep this indicator below 2% per annum in the case of scheduled maintenance (planned outages) and 5% for planned and unplanned outages combined.

Development of Severe Accident Management Guidelines (SAMGs)

The level-2 PSA demonstrated that SGTR events with a dry secondary side of the SG could cause the largest source terms and thereby, a large contributor to the public health risk (Source Terms up to 50% Cs and I). The most promising strategy was the scrubbing of the source term through the water inventory in the SGs. By installing extra pathways to keep the SGs filled with water (including flexible hose connection with the fire-fighting system) a factor 14 reduction in the magnitude of the source term (CsI and CsOH) could be achieved. A closer look at the MAAP4 results showed that the major effect was not the scrubbing effect, but by deposition of fission products on the primary side of the SG tubes. This deposition effect plays also a large role in other core melt scenarios such as ISLOCA.

When core damage in ATWS scenarios cannot be prevented, opening of the PORVs is suggested. Loss of primary inventory is much faster, but creation of steam bubbles will stop the fission process. Also induced SGTR is less probable because of lower primary pressure. In case induced SGTR cannot be prevented lower pressure still helps. Opening of the secondary relief valves is less probable in that case.

Use of PSA source terms for emergency planning & preparedness

In the unlikely event that a severe event occurs at the plant with a serious threat for an off-site emergency, the 16 defined source terms in the PSA of Borssele are used as input for the prognosis. These source terms are already included as default input data in the computer codes being used for forecasting the consequences.

For the definition of the planning zones for evacuation, iodine prophylaxis and sheltering, originally the PWR-5 source term from WASH-1400 (Rasmussen Study) was taken as a conservative reference source term. Because the dose criteria for evacuation, iodine prophylaxis and sheltering were lowered, a re-evaluation of the reference source term was performed by the ANVS. Doing nothing would have resulted in (emergency) planning zones becoming significant larger than before and also larger than actually needed. Therefore, a more realistic and Borssele NPP specific source term was developed, matching the existing planning zone.

d. Transition towards a more Risk-informed Regulation

The ANVS increasingly is confronted with design or operational changes which originate directly from, or are supported by arguments stemming from LPSA-applications at Borssele, and which require approval of the RB. Therefore the IAEA was asked in 1999 to advice in order to support this process. The focal points of this review are illustrated by questions like:

"Are the LPSA-applications at the Borssele NPP state-of-the-art and sufficient, or should the operator do more?", "How should the ANVS respond to these applications, given a small regulatory staff and possible short remaining lifetime of the Borssele NPP?"

Among others the recommendations to the RB were:

- Develop a framework for the use of risk information in regulatory decisions. This should include the identification of objectives, description of the decision-making process and acceptance criteria, and clarification of how risk-informed decision-making is to be incorporated in the existing regulations. Since developing such a framework may take considerable effort, they were suggested to review existing risk-informed frameworks, bearing in mind that acceptance criteria need to be developed for the specific situation in The Netherlands.
- The resources required for accomplishing risk-informed regulation depend on how much use will be made of this approach, however, the IAEA team suggested that, as a minimum, ANVS should continue to allocate one person, having in-depth knowledge of the Borssele PSA, for PSA-related activities, and that all decision-makers should have some training in PSA.
- Finally, IAEA suggested the ANVS to use the PSA to focus the regulatory inspection program on the more significant systems, components, and plant practices.

As a follow-up of this advice, the predecessors of ANVS introduced a more risk-informed regulation. In the meantime a number of risk informed decisions have been made within the supervision activities, like as mentioned optimisation of Technical Specifications. Further a document has been initiated to describe a risk informed decisionmaking approach in practice, but this has still a draft status.

In 2014 a group of ANVS staff received a five-day training in PSA Levels 1 and 2.

Appendix 3 THE SAFETY CULTURE AT BORSSELE NPP

a. Introduction

Reference is made to the Borssele NPP policy document 2001-0914 rev.4 of 2004: *'EPZ supports the intention in respect to safety culture as defined in the IAEA reports 75-INSAG-4, INSAG-12 and INSAG-15. The definition of the term safety culture reflects the way that the organisation is using people, resources and methods. It is the opinion of EPZ that the attitude, way of thinking, professionalism and alertness of every employee is of great importance to safety. EPZ shall take measures to maintain and promote these attitudes'*.

The policy document links up with descriptions of the organisation's 'main processes', as laid down in the Operating Instructions and defined as:

- management and organisation,
- personnel and organisation,
- configuration management,
- operations,
- maintenance.

The main processes form the basis on which the annual departmental plans are drawn up. The policy document is linked to the business plan, which also discusses financial aspects.

b. Introduction of safety culture programme

In 1996 EPZ launched a safety culture programme for the Borssele NPP. This is an ongoing programme in which new activities are defined every year to improve the safety culture of the personnel of the NPP. These include, for example:

- Introduction of the STAR principle to all employees, where STAR means 'Stop, Think, Act and Review'.
- Introduction of the topic of safety culture into toolbox meetings,
- Introduction of work practices sessions into operations and maintenance refresher courses,
- Introduction of the principle of management on the floor and regular management rounds,
- Management training on safety culture,
- Special focus on safety culture when performing root-cause event analyses,
- Involvement of staff in peer reviews of international nuclear power plants,
- Production of 'work practices' training films for contractors and NPP staff.

Below the above mentioned activities are explained to some detail.

Introduction of the STAR principle to all employees

All Borssele NPP staff members have attended a 2-hour training session explaining the STAR principle using day-to-day examples. The STAR principle has been developed to improve normal work practices.

Introduction of the topic of safety culture into toolbox meetings

All operations and maintenance employees are required to attend monthly toolbox meetings at which industrial and radiological safety issues are discussed. Safety culture

issues have now also been introduced. These include the STAR principle, the system of work licences, the nuclear safety tagging system, et cetera.

Introduction of work practices sessions into operations and maintenance refresher courses

Refresher courses include a full-day training session at which work practices are discussed on the basis of undesired events in the past year. There is a special focus on how to handle safety when attention seems to be totally absorbed by time issues. The main message here is: (nuclear) safety first; when there is any doubt, immediately inform management about the issue, so that no unnecessary time will be lost.

Introduction of principle of management on the floor and regular management rounds

An important aspect of safety culture is the communication of 'management expectations'. The best way to communicate these expectations is by the presence of management on the floor, e.g. workers must be in close contact with management in normal working situations, to avoid interpretation problems. This is difficult to do because managers tend to lead busy lives, and their presence on the floor does not have top priority. Special programmes and requirements are needed to force them to make time for it.

At the Borssele NPP, the advancement of the management-on-the-floor approach is being combined with the introduction of regular management rounds for all managers. The management rounds focus on the installation. During them, all deficiencies in the plant are noted. Priority is given to remedying the deficiencies in the right order. The management rounds are scheduled in such a way that management visits every area at least twice a year.

Management training on safety culture

In 1999, Borssele management attended a special training programme on safety culture. Special attention was paid to safety culture aspects in performing root-cause event analyses. Work practices and safety culture can be important root causes of undesired events. To handle this aspect in a systematic way in the root-cause analysis, the HPES methodology developed by WANO has been introduced at Borssele.

Involvement of staff in peer reviews of international nuclear power plants

There is a tendency to drift into accepting small deficiencies in a plant. After a while, things are taken as normal. By involving the staff of the NPP in international peer reviews, it is possible to re-establish the 'normal standard'. On average, five employees of the Borssele NPP are involved in international peer reviews (INPO (HPES), OSART) every year.

Production of 'work practices' training films for contractors and NPP staff

The Borssele NPP has produced a one-hour training film showing examples of good and bad practice in normal working situations. All NPP staff and staff of most of the main contractors must watch it. Because the film is highly realistic and field workers recognise the situations shown in it, it is highly effective in improving work practices. The film is updated every year on the basis of the yearly event analysis. In 2001, showings of the film were preceded by a presentation by maintenance managers. This proved an effective way of communicating management expectations.

c. Evaluation of safety culture programme

In the years 2004-2006 it was concluded that the safety culture programme needed an extra effort. This was based on the increasing number of small incidents and reported

incidents to the regulator, but also on the results of evaluations that concluded that root causes of incidents are mainly work practices, non-compliance with procedures and communication, and that this has been the case for years without improvement. At the same time the international organisations like WANO and IAEA warned about complacency. Several international documents were stressing the importance of safety management and safety culture. Also the inspection branche of the RB requested to look into the international developments in its assessment report (2005) of the 10-yearly safety evaluation. In 2006, the Covenant was agreed, that allowed for 20 years extra for operation, if certain conditions are met. This offered a new horizon and a perspective for the operating organisation and added to the importance of a safety culture program.

In reaction to this the Borssele NPP started amongst others to introduce the following steps:

- Introduction in 2005 of the function 'Safety culture officer' who has the duty to establish and follow-up the overall safety culture and human performance plan;
- Using the WANO Performance Objectives and Criteria and the WANO good practises;
- Using WANO support and trainings to introduce for instance Operational Decision Making, Pre- and Post- job briefing;
- Increasing the frequency of WANO peer reviews;
- Company culture improvement plan 2007-2008;
- From 2008 onwards, a Human Performance & Safety Culture (HP&SC) improvement plan introducing INSAG-15 and WANO guidelines for Human Performance.

Important results in 2009-2010 were:

- Improvement plan from a WANO Peer review in 2008 (follow-up in 2010)
- Documented and visible Safety Policy Statement (policy level commitment)
- Management Expectations pocket booklets per main department (management commitment)
- Human Performance Techniques (individual commitment) using INPO 06-002, as translated in Dutch (training includes contractors)
- Management Expectations and HP&SC becoming an element of the Quality Management System.

The Borssele NPP and the RB evaluate each year what the results are of this new approach. The evaluation meetings also focus on developments regarding performance indicators and regular independent review of safety culture. It has been decided to enlarge the scope of the annual meetings to include organisational developments. Furthermore in the OSART mission in September 2014 an additional Independent Safety Culture Assessment module was used. Subsequently Borssele intensified effort for improvement of safety culture. During the OSART follow-up meeting in December 2016 the IAEA will also perform an interim review on safety culture (together with MOA⁸⁹ and corporate). In the autumn of 2017 the actual follow-up meeting on safety culture is expected.

⁸⁹ Management, Organization and Administration, MOA

Appendix 4 REQUIREMENTS AND SAFETY GUIDES FOR THE BORSSELE NPP LICENCE

In the licence of the NPP, in licence condition II.B.7, Nuclear Safety Rules and Guidelines are referred, documented in NVRs. These are listed in the table.

No.	Title
NVR NS-R-3	<i>'Beoordeling van de vestigingsplaats voor kernenergiecentrales'</i> Adaptation of: IAEA Safety Requirements Safety Standard Series No. NS-R-3, Site Evaluation for Nuclear Installations Safety Requirements
NVR NS-G-3.1	<i>'Externe door de mens veroorzaakte gebeurtenissen bij de beoordeling van de vestigingsplaats voor kernenergiecentrales'</i> Adaptation of: IAEA Safety Guide Safety Standard Series No. NS-G-3.1, External Human Induced Events in Site Evaluation for NPPs
NVR NS-G-3.2	<i>'Verspreiding van radioactieve stoffen in lucht en water en beschouwing van de verdeling van de bevolking bij de beoordeling van de vestigingsplaats voor kernenergiecentrales'</i> Adaptation of: IAEA Safety Guide Safety Standard Series No. NS-G-3.2, Dispersion of Radioactive Material in Air and Water and Consideration of Population Distribution in Site Evaluation for NPPs
NVR NS-G-3.3	<i>'Beoordeling van seismische gebeurtenissen van invloed op de veiligheid van kernenergiecentrales'</i> Adaptation of: IAEA Safety Guide Safety Standard Series No. NS-G-3.3, Evaluation of Seismic Hazards for NPPs
NVR NS-G-3.4	<i>'Meteorologische gebeurtenissen bij de beoordeling van de vestigingsplaats voor kernenergiecentrales'</i> Adaptation of: IAEA Safety Guide Safety Standard Series No. NS-G-3.4, Meteorological Events in Site Evaluation of NPPs
NVR NS-G-3.5	<i>'Beoordeling van overstromingsgevaar voor kernenergiecentrales met vestigingsplaats aan de kust of aan een rivier'</i> Adaptation of: IAEA Safety Guide Safety Standard Series No. NS-G-3.5, Flood Hazard for NPPs on Coastal and River Sites
NVR NS-G-3.6	<i>'Geotechnische aspecten bij de beoordeling van de vestigingsplaats en funderingen voor kernenergiecentrales'</i> Adaptation of: IAEA Safety Guide Safety Standard Series No. NS-G-3.5, Geotechnical Aspects of Site Evaluation and Foundations for NPPs
NVR NS-R-1	<i>'Veiligheid van kernenergiecentrales: veiligheidseisen voor het ontwerp'</i> Adaptation of: IAEA Safety Requirements Safety Standard Series No. NS-R-1, Safety of Nuclear Power Plants: Design Safety Requirements
NVR NS-G-1.1	<i>'Programmatuur voor computergestuurde veiligheidsrelevante systemen voor kernenergiecentrales'</i> Adaptation of: IAEA Safety Guide Safety Standard Series No. NS-G-1.1, Software for Computer Based Systems Important to Safety in NPPs
NVR NS-G-1.2	<i>'Veiligheidsbeoordeling en -verificatie voor kernenergiecentrales'</i> Adaptation of: IAEA Safety Guide Safety Standard Series No. NS-G-1.2, Safety Assessment and Verification for NPPs

No.	Title
NVR NS-G-1.3	<p><i>'Veiligheidsrelevante meet- en regelsystemen voor kernenergiecentrales'</i> Adaptation of: IAEA Safety Guide Safety Standard Series No. NS-G-1.3, Instrumentation and Control Systems Important to Safety in NPPs</p>
NVR NS-G-1.4	<p><i>'Ontwerp van splijtstofhantering en -opslag systemen in kernenergiecentrales'</i> Adaptation of: IAEA Safety Guide Safety Standard Series No. NS-G-1.4, Design of Fuel Handling and Storage Systems in NPPs</p>
NVR NS-G-1.5	<p><i>'Externe gebeurtenissen met uitzondering van aardbevingen in het ontwerp van kernenergiecentrales'</i> Adaptation of: IAEA Safety Guide Safety Standard Series No. NS-G-1.5, External Events Excluding Earthquakes in the Design of NPPs</p>
NVR NS-G-1.6	<p><i>'Seismisch ontwerp en kwalificatie voor kernenergiecentrales'</i> Adaptation of: IAEA Safety Guide Safety Standard Series No. NS-G-1.6, Seismic Design and Qualification for NPPs</p>
NVR NS-G-1.7	<p><i>'Bescherming tegen interne branden en explosies in het ontwerp van kernenergiecentrales'</i> Adaptation of: IAEA Safety Guide Safety Standard Series No. NS-G-1.7, Protection Against Internal Fires and Explosions in the Design of NPPs</p>
NVR NS-G-1.8	<p><i>'Ontwerp van noodstroom systemen voor kernenergiecentrales'</i> Adaptation of: IAEA Safety Guide Safety Standard Series No. NS-G-1.8, Design of Emergency Power Systems for NPPs</p>
NVR NS-G-1.9	<p><i>'Ontwerp van het reactor koel- en aanverwante systemen in kernenergiecentrales'</i> Adaptation of: IAEA Safety Guide Safety Standard Series No. NS-G-1.9, Design of the Reactor Coolant System and Associated Systems in NPPs</p>
NVR NS-G-1.10	<p><i>'Ontwerp van reactor insluiting systemen voor kernenergiecentrales'</i> Adaptation of: IAEA Safety Guide Safety Standard Series No. NS-G-1.10, Design of Reactor Containment Systems for NPPs</p>
NVR NS-G-1.11	<p><i>'Bescherming tegen interne gevaren anders dan branden en explosies in het ontwerp van kernenergiecentrales'</i> Adaptation of: IAEA Safety Guide Safety Standard Series No. NS-G-1.11, Protection Against Internal Hazards other than Fires and Explosions in the Design of NPPs</p>
NVR NS-G-1.12	<p><i>'Ontwerp van de reactor kern voor kernenergiecentrales'</i> Adaptation of: IAEA Safety Guide Safety Standard Series No. NS-G-1.12, Design of the Reactor Core for NPPs</p>
NVR NS-G-1.13	<p><i>'Stralingsbescherming aspecten in het ontwerp voor kernenergiecentrales'</i> Adaptation of: IAEA Safety Guide Safety Standard Series No. NS-G-1.13, Radiation Protection Aspects of Design for NPPs</p>
NVR NS-R-2	<p><i>'Veiligheid van kernenergiecentrales: veiligheidseisen voor de bedrijfsvoering'</i> Adaptation of: IAEA Safety Requirements Safety Standard Series No. NS-R-2, Safety of Nuclear Power Plants: Operation Safety Requirements</p>

No.	Title
NVR NS-G-2.1	<i>'Brandveiligheid in de bedrijfsvoering van kernenergiecentrales'</i> Adaptation of: IAEA Safety Guide Safety Standard Series No. NS-G-2.1, Fire Safety in the operation of NPPs
NVR NS-G-2.2	<i>'Bedrijfslimieten en -voorwaarden en bedrijfsvoeringsprocedures voor kernenergiecentrales'</i> Adaptation of: IAEA Safety Guide Safety Standard Series No. NS-G-2.2, Operational Limits and Conditions and Operating Procedures for NPPs
NVR NS-G-2.3	<i>'Wijzigingen aan kernenergiecentrales'</i> Adaptation of: IAEA Safety Guide Safety Standard Series No. NS-G-2.3, Modifications to NPPs
NVR NS-G-2.4	<i>'De bedrijfsvoeringsorganisatie voor kernenergiecentrales'</i> Adaptation of: IAEA Safety Guide Safety Standard Series No. NS-G-2.4, The Operating Organization for NPPs
NVR NS-G-2.5	<i>'Beheer van de kern en splijtstof hantering voor kernenergiecentrales'</i> Adaptation of: IAEA Safety Guide Safety Standard Series No. NS-G-2.5, Core Management and Fuel Handling for NPPs
NVR NS-G-2.6	<i>'Onderhoud, toezicht en in-service inspecties in kernenergiecentrales'</i> Adaptation of: IAEA Safety Guide Safety Standard Series No. NS-G-2.6, Maintenance, Surveillance and In-service Inspection in NPPs
NVR NS-G-2.7	<i>'Straling bescherming en radioactief afval tijdens het bedrijven van kernenergiecentrales'</i> Adaptation of: IAEA Safety Guide Safety Standard Series No. NS-G-2.7, Radiation Protection and Radioactive Waste Management in the Operation of NPPs
NVR NS-G-2.8	<i>'Werving, kwalificatie en training van personeel voor kernenergiecentrales'</i> Adaptation of: IAEA Safety Guide Safety Standard Series No. NS-G-2.8, Recruitment, Qualification and Training of Personnel for NPPs
NVR NS-G-2.9	<i>'Inbedrijfstelling voor kernenergiecentrales'</i> Adaptation of: IAEA Safety Guide Safety Standard Series No. NS-G-2.9, Commissioning for NPPs
NVR NS-G-2.10	<i>'Periodieke veiligheidsbeoordeling voor kernenergiecentrales'</i> Adaptation of: IAEA Safety Guide Safety Standard Series No. NS-G-2.10, Periodic Safety Review of NPPs
NVR NS-G-2.11	<i>'Een systeem voor de terugkoppeling van ervaringen van gebeurtenissen in nucleaire installaties'</i> Adaptation of: IAEA Safety Guide Safety Standard Series No. NS-G-2.11, A System for the Feedback of Experience from Events in Nuclear Installations
NVR NS-G-2.12	<i>'Verouderingsbeheer voor kernenergiecentrales'</i> Adaptation of: IAEA Safety Guide Safety Standard Series No. NS-G-2.12, Ageing Management for NPPs
NVR NS-G-2.13	<i>'Beoordeling van seismische veiligheid voor bestaande nucleaire installaties'</i> Adaptation of: IAEA Safety Guide Safety Standard Series No. NS-G-2.13, Evaluation of Seismic Safety for Existing Nuclear Installations
NVR NS-G-2.14	<i>'Bedrijfsvoering van kernenergiecentrales'</i> Adaptation of: IAEA Safety Guide Safety Standard Series No. NS-G-2.14, Conduct of operations at NPPs

APPENDIX 4 REQUIREMENTS AND SAFETY GUIDES

No.	Title
NVR NS-G-2.15	<i>'Beheer van zware ongevallen voor kernenergiecentrales'</i> Adaptation of: IAEA Safety Guide Safety Standard Series No. NS-G-2.15, Severe Accident Management Programmes for NPPs
NVR GS-R-3	<i>'Het managementsysteem voor faciliteiten en activiteiten'</i> Adaptation of: IAEA Safety Requirements Safety Standard Series No. GS-R-3, The Management System for Facilities and Activities
NVR GS-G-3.1	<i>'Toepassing van het managementsysteem voor faciliteiten en activiteiten'</i> Adaptation of: IAEA Safety Guide Safety Standard Series No. GS-G-3.1, Application of the Management System for Facilities and Activities
NVR GS-G-3.5	<i>'Het managementsysteem van nucleaire installaties'</i> Adaptation of: IAEA Safety Guide Safety Standard Series No. GS-G-3.5, The Management System of Nuclear Installations
NVR GS-R-4	<i>'Veiligheidsbeoordeling voor faciliteiten en activiteiten'</i> Adaptation of: IAEA Safety Requirements Safety Standard Series No. GS-R-4, Safety Assessment for Facilities and Activities
NVR GS-G-4.1	<i>'Vorm en inhoud van het veiligheidsrapport voor kernenergiecentrales'</i> Adaptation of: IAEA Safety Guide Safety Standard Series No. GS-G-4.1, Format and Content of the Safety Analysis Report for NPPs
NVR SSG-9	<i>'Seismische gevaren bij de beoordeling van de vestigingsplaats voor nucleaire installaties'</i> Adaptation of: IAEA Safety Guide Safety Standard Series No. SSG-9, Seismic Hazards in Site Evaluation for Nuclear Installations
NVR SSG-2	<i>'Deterministische veiligheidsanalyse voor kernenergiecentrales'</i> Adaptation of: IAEA Safety Guide Safety Standard Series No. SSG-2, Deterministic Safety Analysis for NPPs
NVR SSG-3	<i>'Ontwikkeling en toepassing van niveau 1 probabilistische veiligheidsanalyse voor kernenergiecentrales'</i> Adaptation of: IAEA Safety Guide Safety Standard Series No. SSG-3, Development and Application of Level 1 Probabilistic Safety Assessment for NPPs
NVR SSG-4	<i>'Ontwikkeling en toepassing van niveau 2 probabilistische veiligheidsanalyse voor kernenergiecentrales'</i> Adaptation of: IAEA Safety Guide Safety Standard Series No. SSG-4, Development and Application of Level 2 Probabilistic Safety Assessment for NPPs
NVR GS-R-2	<i>'Gereedheid voor en bestrijding van een nucleaire of radiologische noodsituatie'</i> Adaptation of: IAEA Safety Requirements Safety Standard Series No. GS-R-2, Preparedness and Response for a Nuclear or Radiological Emergency
NVR GS-G-2.1	<i>'Vorbereiding voor de gereedheid voor en bestrijding van een nucleaire of radiologische noodsituatie'</i> Adaptation of: IAEA Safety Guide Safety Standard Series No. GS-G-2.1, Arrangement for Preparedness and Response for a Nuclear or Radiological Emergency

No.	Title
NVR SSG-30	<i>'Safety Classification of Structures, Systems and Components in Nuclear Power Plants'</i> Adaptation of: IAEA Specific Safety Guide No. SSG-30
NVR 3.2.1	Voorschriften Opleiding van Bedieningspersoneel van Kernenergiecentrales

Appendix 5 TECHNICAL DETAILS OF BORSSELE NPP

a. Technical specifications

The Borssele nuclear power plant is a light water PWR with a thermal power of 1366 MW and a net electrical output of approximately 490 MW. The installation is a two-loop plant designed by Siemens/KWU. The plant has been in operation since 1973. The reactor and the primary system, including steam generators, are in a spherical steel containment. This steel containment is enveloped by a secondary concrete enclosure.

The Borssele NPP characteristics can be found in the following publications:

- the Netherlands' National Report on the post – Fukushima Daiichi stress test for the Borssele NPP, published in December 2011
(link: <http://www.rijksoverheid.nl/bestanden/documenten-en-publicaties/rapporten/2011/12/20/nationaal-rapport-over-de-stresstest-van-de-kerncentrale-borssele/netherlands-national-report-on-the-post-fukushima-stress-test.pdf>)
- The report by LH EPZ on the Complementary Safety margin Assessment (CSA, a.k.a 'stress test'), published October 31 2011
(link: <http://www.kerncentrale.nl/resultatenrobuustheidsonderzoek/EN/>)

The end of this Annex shows graphs of the overall plant availability over the years, the number of incident reports from 1990 onwards and the number of unwanted automatic scrams over the years.

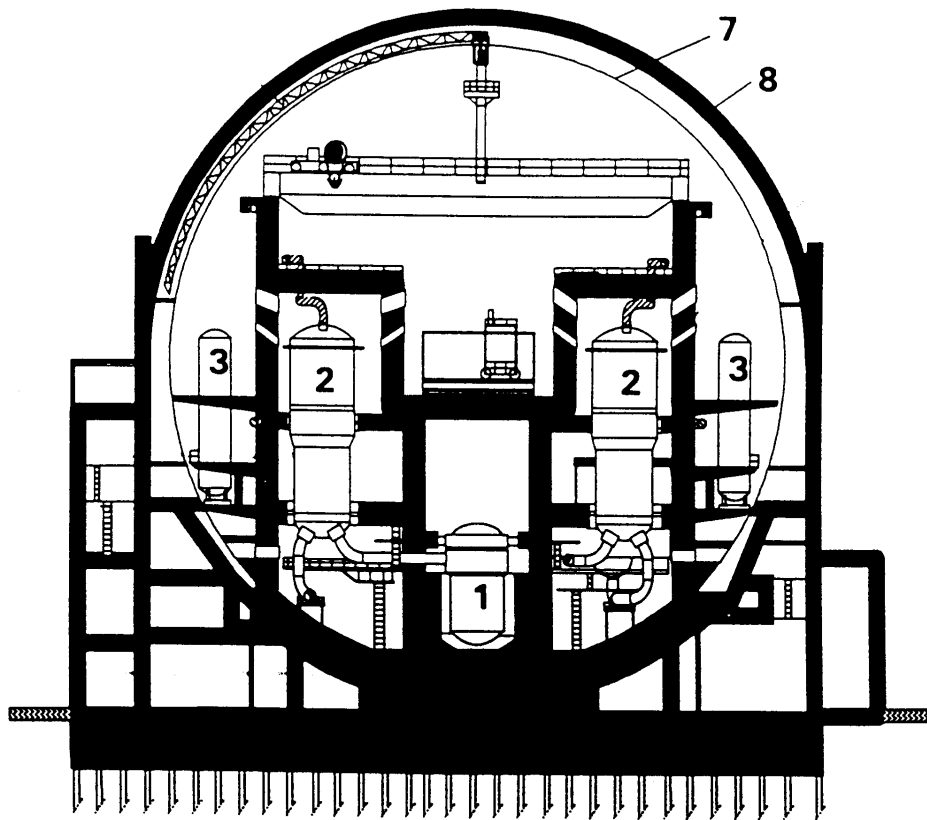

Figure 4 Cross-section of reactor building of Borssele NPP

1. Reactor pressure vessel
2. Steam generator
3. Medium-pressure core inundation buffer tank
7. Steel containment
8. Secondary concrete enclosure (shield building)

b. Safety improvements from the first 10-yearly Periodic Safety Review

In the late 1980s, mainly as a result of the Chernobyl accident, the Dutch government formulated an accident management and back-fitting policy. Both existing utilities at that time (Borssele and Dodewaard) were asked to upgrade the safety of their plants by incorporating state-of-the-art features. With the aid of the respective reactor suppliers, the two utilities developed a new safety concept for their plants in the early 1990s. The utility operating the Borssele NPP (which was 20 years old at the time) embarked on a € 200 million modification programme, while Dodewaard was closed because of economic reasons.

The new safety concept was largely based on a comparison of the plant's current design basis with national and international deterministic nuclear safety rules; deterministic studies of the plant; insights gained from similar designs; operating experience and, last but not least, insights derived from the German Risk Study (DRS-B). A plant-specific PSA was performed in parallel with the activities for the conceptual design. This PSA played a major role in later stages of the modification programme. Once the safety concept had been finalised, it was translated into a 'safety plan', consisting of a package of modification proposals for the plant systems, structures and components. In the previous CNS-5 report an extensive list of important modifications can be found.

The main goals of the safety improvements were:

- Extensive improvement of functional and physical separation of redundant systems and increase of redundancies and some diverse systems;
- Improvement of protection against external events (e.g. reserve residual heat removal by well pumps, emergency control room in hardened building, emergency response center in bunker);
- Improve protection against LOCA, SB-LOCA, MSLB, SGTR and SBO;
- Improve AM and SAM (introduction of SAMG's, PAR's and filtered venting, bleed and feed);
- Modernisation of control room and full scope simulator.

c. Modifications due to the second 10-yearly Periodic Safety Review

The Borssele NPP in 2003 finalised its second 10-yearly periodic safety review. The safety-interests of the improvement-issues have been estimated, from a nuclear safety point of view as well as from a radiation protection point of view using both deterministic and probabilistic considerations.

The probabilistic safety interest of an improvement issue is based upon the maximum possible decrease of the core damage frequency (TCDF PSA level 1) and the decrease of the individual risk (IR PSA level 3). For each echelon of the defence in depth concept modifications have been suggested. In the period 2005-2007, the majority of the modifications has been implemented.

The main goal in the technical area was to further strengthen the safety concept that was introduced in the 1st PSR. On the other hand to put increased efforts in the area of safety analysis, ageing aspect, the organisation and emergency procedures. A list of improvements has been presented in the CNS-5 report. Some items still relevant today e.g. in relation to post-Fukushima Daiichi evaluations are:

Technical measures:

- Increasing the supply of diesel oil in the bunker systems from 24 hours to 72 hours;
- Installation of a second reserve cooling water (TE) pump;

- Automatic starting of the bunkered primary reserve injection system if the level in the RPV becomes too low during midloop operation;

Organisational, personal and administrative measures:

- Improvement of the Emergency Operating Procedures (EOPs) with regard to avoiding dilution of the primary coolant after start-up of a main coolant pump;
- Implementation of Severe Accident Management Guidelines (SAMGs) for low-power and shut-down modes of operation;
- Implementation of an E-0 optimal recovery guideline for low-power and shut-down modes of operation (E-0 = reactor trip and safety injection, diagnostics)

Man-machine interface (MMI) and emergency procedures

MMI was an important topic in the Borssele back-fitting programme that was implemented in 1997. It encompassed:

- enlargement and complete retrofit of the main control room,
- addition of a secondary (emergency) control room in a new external events hardened building,
- a full-scope replica simulator (at a training center in Germany), including main and secondary control room,
- an emergency response and communication facility in the cellar under the office building.

With the introduction of the Westinghouse procedures in the middle of the nineties also the Critical Safety Functions monitor was introduced in the control room.

At the Borssele NPP, an integrated Event-Based and Symptom-Based package of Emergency Operating Procedures (EOPs) is used:

- The Optimal Recovery Guidelines (ORGs); 'Event'-based procedures for LOCA, Secondary Line Break, SGTR and combinations of these.
- The Function Restoration Guidelines (FRGs); 'Symptom'-based procedures for the overall safety of the plant.

In the CNS-5 report for the fifth review meeting more details about the design of the MMI and the control room can be found in its Annex on the Technical Details of Borssele NPP.

d. Third PSR

The evaluation report on the 3rd PSR was finished by the end of 2013. It yielded more than 100 recommendations. A number of actions from the EUROPEAN stress test merged with the measures that were decided on based on the 3rd PSR. Eleven modifications had such influence on the safety report that a modification of the licence was necessary. They are:

Mod	Modification for which license is needed
W01	Automated activation of the backup emergency-cooling-water-system and the backup spent-fuel-pool-cooling system
W02	Inserting additional battery capacity on emergency-power-net 1

W03	Pressurizer-relief-valve and other specific valves of the primary backup makeup system, steam-generator dump valves, volume-control system, reactor coolant - en residual-heat-removal system made adressable from the backup controlroom
W04	Connections to the primary backup-Makeup-system for primary injection
W05	Connections for mobile diesel generator on 380 V emergency-power-net 1 rails CU/CV
W06	Adjustments to the spent-fuel-pool-cooling system
W07	Seperation of suction areas reactor coolant- en residual-heat-removal-system and addition of reverse current possibility for sump operation
W08	Installation of an independant power net connection in case of loss of offsite power (6kV rails BA/BB)
W09	External cooling of the reactor-pressure-vessel
W10	Isolation of the volume-control-system at the passage of the containment
W11	Expansion of the limits and controls of het reactivity-control-rod-system

The implementation is foreseen until 2017.

One issue that will need special attention from the ANVS is digital I&C.

The allowance for long-term operation until 2034 made it unavoidable to replace the still analog reactor control and limitation systems (RCLS) of the Borssele NPP with digital systems. These replacements will be carried out in 2017.

e. Data on radiation protection and exposure

There has been a downward trend in the average effective individual dose at the Borssele plant ever since 1983. This is true both for plant personnel and for externally hired personnel. In the early eighties, the average effective individual dose was 4 mSv per annum for Borssele personnel and 5 mSv per annum for externally hired personnel. By the end of the nineties, the figures had decreased to 1 mSv and 1.5 mSv respectively. The trend of low doses seems to continue past the millennium.

The trend in the collective dose has been very similar to that in the individual doses. The total collective dose amounted to 4 manSv per annum in the early eighties. By the end of the nineties it had decreased to 1.0 manSv per annum. The trend of low doses has continued past the millennium.

Apart from the regular activities, the modification activities carried out in 1997 resulted in an additional collective dose of 1.8 manSv. The highest individual dose received in 1997 was 14.0 mSv.

The legal dose limits for members of the public are as follows:

- dose limit for any one source is 0.1 mSv per annum;

- dose limit for all sources together is 1 mSv per annum.

See Appendix 1 for the background to and justification of these figures.

The discharge limits in the licence for the Borssele NPP are as follows:

Allowed releases in air per annum:

Noble gases	500	TBq
Halogens	50	GBq, ...of which a maximum of 5 GBq I-131
Aerosols	500	MBq
Tritium	2	TBq
Carbon-14	300	GBq

Allowed releases in water per annum:

Alpha emitters	200	MBq
Beta/gamma emitters (excl. 3H)	200	GBq
Tritium	30	TBq

The dose consequences to members of the public due to releases in amounts equal to the aforementioned limits are estimated to be:

- maximal individual dose from releases in air: about 0.7 microSv per annum;
- maximal individual dose from releases in water: about 0.01 microSv per annum.

Actual releases from 1973 onwards are shown on the following pages. As the actual releases are normally less than 5% of these discharge limits, the actual doses are also less than 5% of the aforementioned maximum doses.

The (actual) collective dose to the public from the releases in air is estimated at $1 * 10^{-3}$ manSv per annum.

The (actual) collective dose to the public from the releases in water is estimated at $5.3 * 10^{-6}$ manSv per annum.

g. Discharges, doses and other relevant diagrams for Borssele NPP

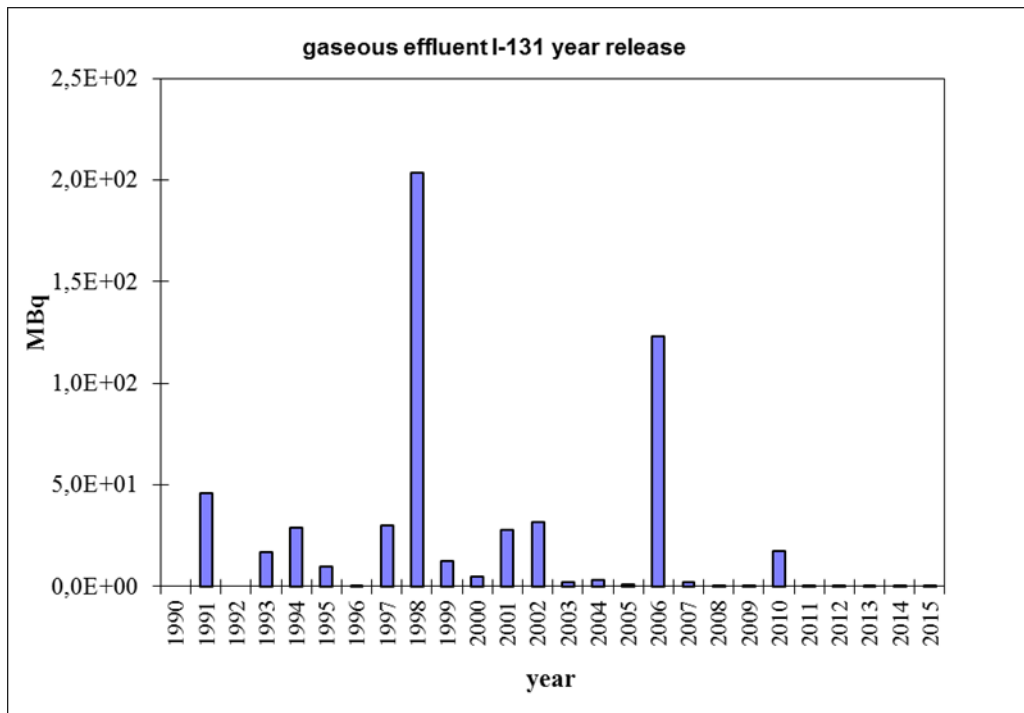

Figure 5 Borssele NPP discharges in air of I-131. Licence limit is 5000 Mq/year.

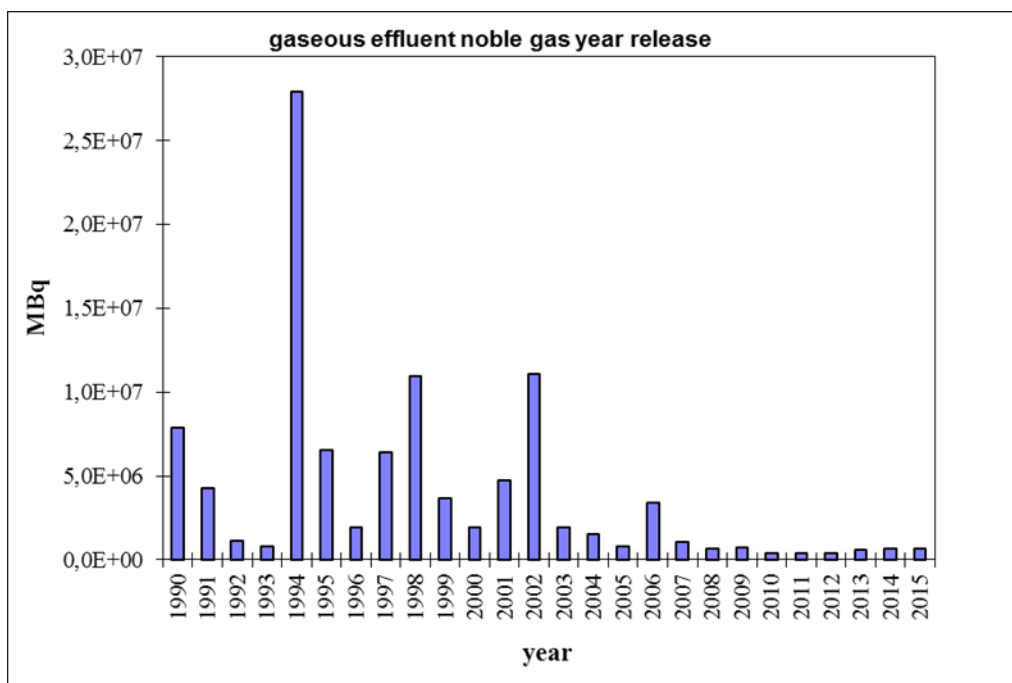

Figure 6 Borssele NPP discharges in air of noble gases. Licence limit is 500 TBq/year.

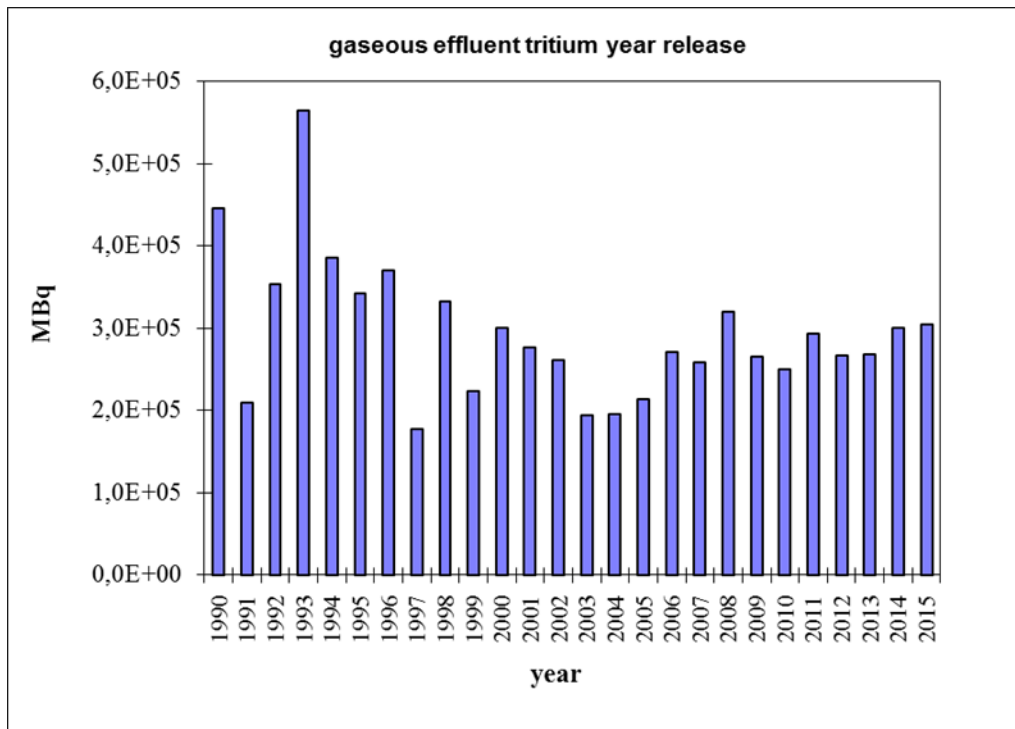

Figure 7 Borssele NPP discharges in air of tritium, licence limit 2 TBq/year.

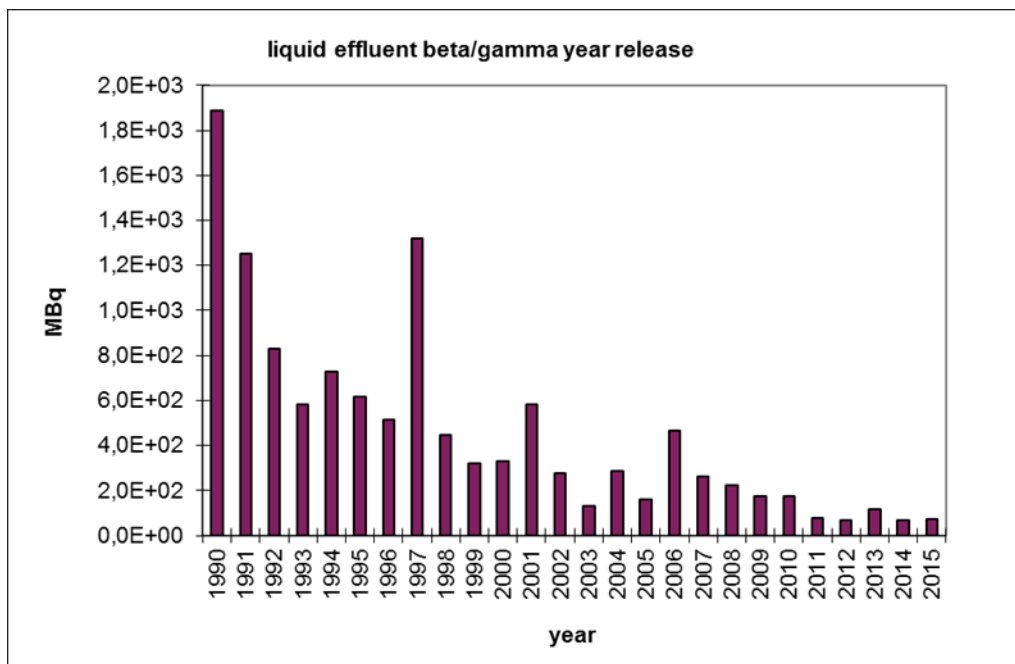

Figure 8 Borssele NPP discharges in water of beta/gamma emitters. Licence limit 200 Gbq/year.

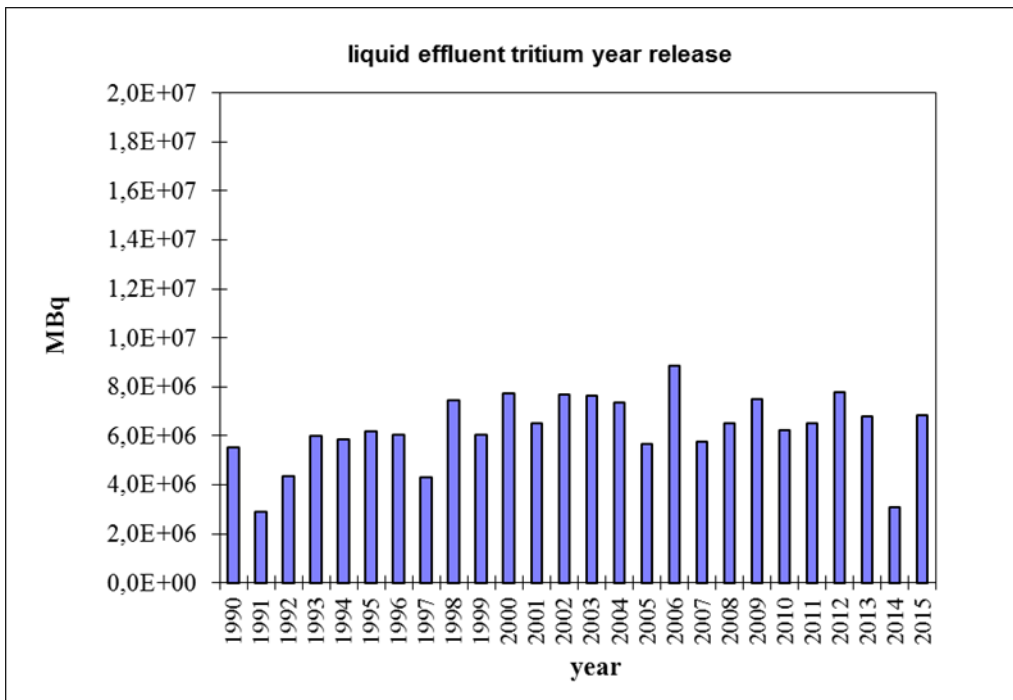

Figure 9 Borssele NPP discharges in water of tritium, licence limit 30 TBq/year

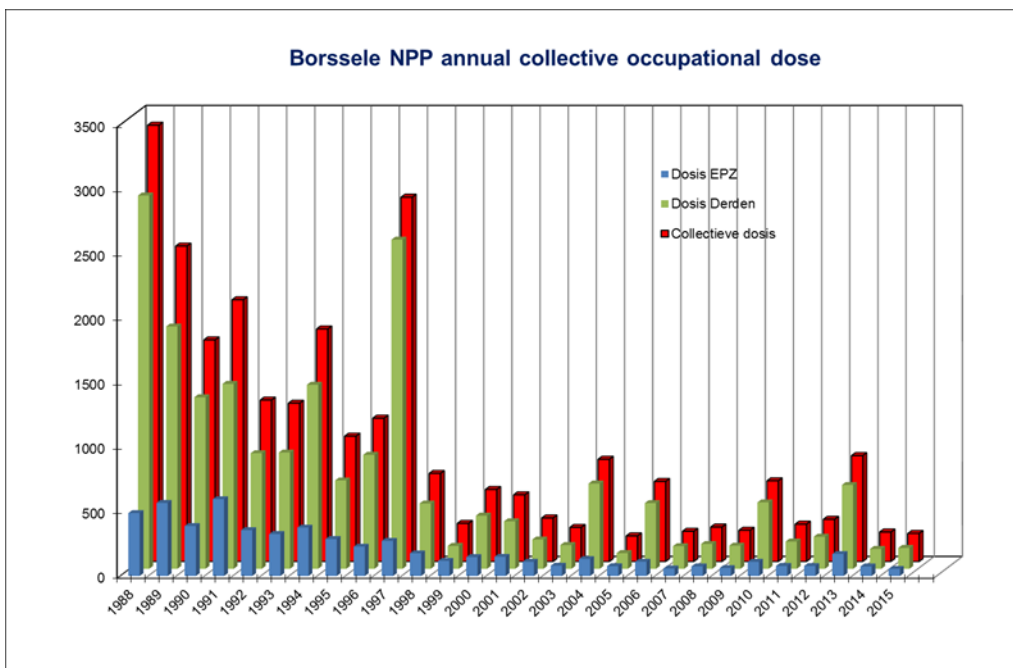

Figure 10 Borssele NPP annual collective occupational dose

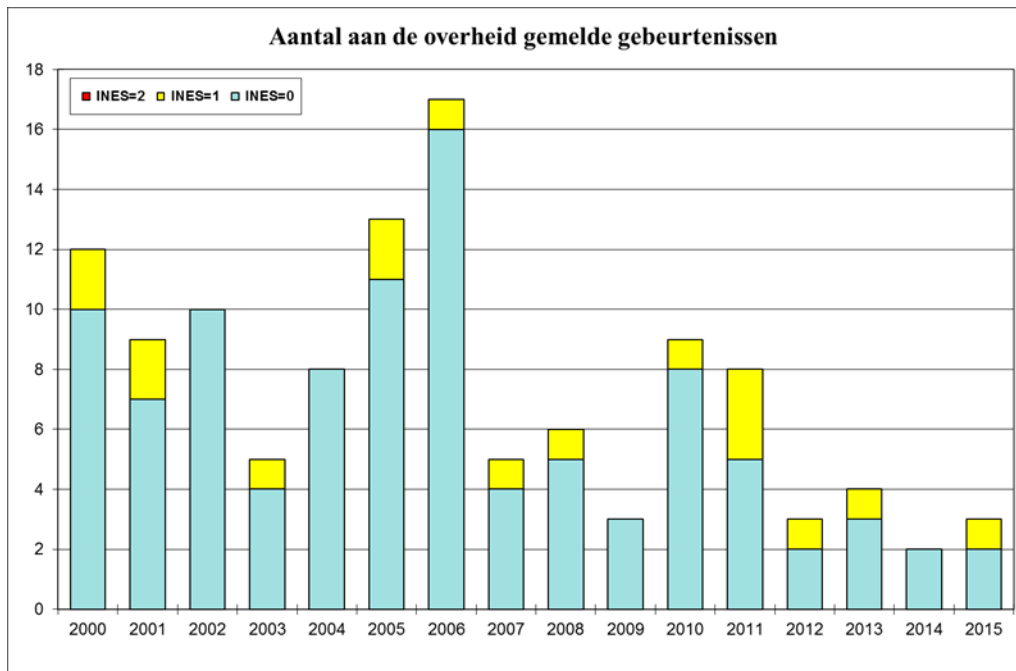

Figure 11 Number of incident reports

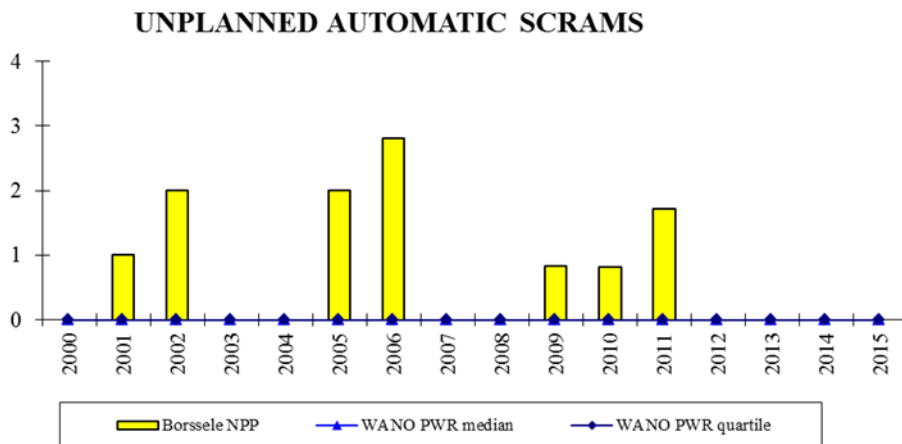

Figure 12 Unplanned automatic scrams.

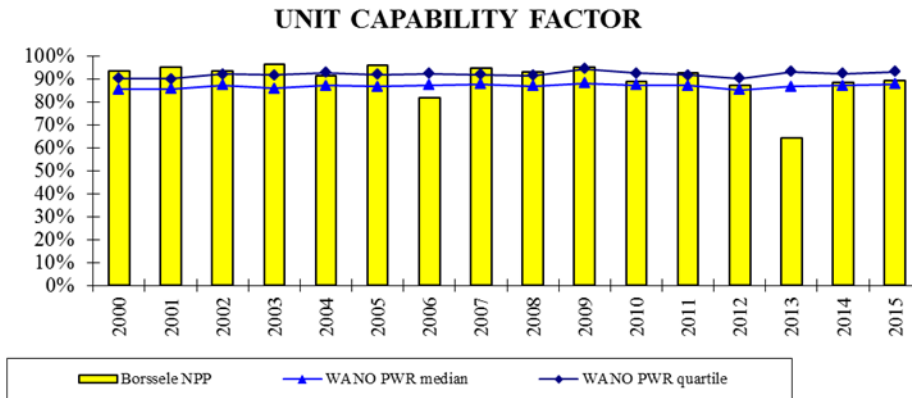

Figure 13 Unit capability factor.

Trend A Median is the world-wide trend, based on the WANO database, Trend B is the trend of the Borssele NPP.

Appendix 6 BORSSELE NPP COVENANT

Introduction Covenant

The operation licence for the Borssele nuclear power plant was issued in 1973 and does not contain a predetermined expiration date. This means that as long as the requirements (as stated in the regulations and the licence) are fulfilled, the plant is allowed to operate. The Regulatory Body (RB) is charged with the monitoring and control of the requirements and will intervene if necessary.

Following political pressure to shut down the plant (first by the end of 2003, later by the end of 2013) and in consideration of the new tasks and responsibilities of the government in the, now liberalized, energy production market, the desirability of a clearly predefined expiration date for the licence was recognized by the government. However, a unilateral decision of the RB to shut down the plant on a short notice, even if technically possible, might lead to a considerable claim. Also it was recognized that technical possibilities exist for continuing to operate the Borssele NPP safely after 2013 and that continued operation after 2013 could help to reduce greenhouse gas emissions.

An agreement with the owners of the Borssele NPP (EPZ) and its shareholders Essent and Delta was therefore pursued, by which several issues could be settled and from which both the government and the plant owners could benefit. This resulted in the 'Borssele Nuclear Power Plant Covenant' which was signed in June 2006 by the Dutch government and the owners of the plant. In the covenant they agreed upon extending the operating life of the plant to no later than December 31st 2033 and the additional conditions which should be met during the remaining operating life. The agreements in the covenant are in addition to the requirements of the operation licence, which remains in full force.

The main agreements in the Covenant, besides the closing date, regard: 1) a so-called 'safety-benchmark'; 2) extra incentive for more sustainable energy management in relation to the closing date of the Borssele plant; 3) funding of decommissioning costs. The translation of the complete Covenant can be found in the CNS-5 report of the Netherlands⁹⁰.

The so-called 'safety-benchmark' agreement relates to the safety of the Borssele power plant. It requires that the Borssele NPP keeps belonging to the top-25% in safety of the fleet of water-cooled and water-moderated reactors in the European Union, Canada and the USA. To assess whether Borssele NPP meets this requirement, the Borssele Benchmark Committee (BBC) has been established.

Borssele Benchmark Committee

At the end of 2008 the Borssele Benchmark committee was established by the parties of the 'Borssele Nuclear Power Plant Covenant'. In accordance with the Covenant, two members of this committee were appointed by the central government, two more were appointed by the owners of the plant. All Covenant parties jointly appointed the chairman of the committee.

Methodology

The committee should determine if the NPP is among the twenty-five percent safest water-cooled and water-moderated power reactors in the European Union, the US and Canada. This implies ranking the safety of about 250 power stations and establishing whether Borssele is among the safest 25%. The safety analysis should cover the design,

⁹⁰ published September 2010 for the fifth review meeting in April 2011.

operation, maintenance, ageing and safety management. The committee developed a methodology for assessing the safety performance of the Borssele NPP as required by the Covenant.

The committee feels confident that with smart use of the available data combined with expert qualitative assessment it will be possible to conclude with sufficient confidence if KCB is among the safest 25% of power stations or not.

To do so it decided to make a separate safety evaluation of the reactor design and the way reactors are operated. The latter assessment will cover operation, maintenance, ageing and safety management. Considering its task the committee focuses only on safety aspects that are relevant for the surrounding environment of the plant. Risks that may lead to damage of the plant and/or personnel operating the plant but provide no hazard outside the plant are not taken into account. The economic impact of these risks can be considerable but are solely born by the plant owner.

The first report of the committee was published in September 2013. The committee concluded the following: "Using the developed methodology the committee compared the safety of the approximate 250 plants. From this assessment the committee unanimously concluded that both in design and operations the KCB is well within the top 25% safest water-cooled and water-moderated reactors in the EU, USA and Canada. So the plants meets, at this moment, the conditions in the covenant regarding its safety to continue operation".

Planning

The second report of the committee will be available in 2018.

Appendix 7 HIGH FLUX REACTOR (HFR)

a. General description

The HFR is a relatively large research reactor with a current thermal output of 45 MW_{th}. It is a tank in pool type reactor of a design similar to the old Oak Ridge Reactor in the USA. Comparable reactors are the R2 reactor in Studsvik, Sweden and the Safari reactor in Palindaba, South Africa. The latter is still in operation.

The aluminium reactor vessel with 4.5 cm thick walls (core box) is located at the bottom of a 9 m deep pool (Figure 14). It operates at a low primary pressure of several bars. In 1984 the first reactor vessel was replaced by the current vessel, partly because radiation induced embrittlement of the core box was suspected. Later, it turned out that this embrittlement was far less than anticipated. The reactor vessel and the reactor pool are located inside a gas-tight steel containment with a 25 m diameter and 12 mm thick walls. A closed primary cooling circuit is connected to the reactor vessel. This primary circuit consists of 16" and 24" aluminium piping, a 43 m³ decay tank, three electrically driven main primary cooling pumps and three heat exchangers. The heat is discharged by an open secondary system, pumping water from a canal to the sea. The decay tank, primary pumps and heat exchangers are located in a separate pump building, together with two electrically driven decay heat removal pumps. In addition, decay heat can also be discharged by natural circulation over core and pool.

The HFR was originally designed to operate with over 89% high enriched U.A1x as fuel. In 2005 a new licence was issued to operate the reactor in future using low enriched uranium (LEU) with an enrichment of less than 20%. The conversion from HEU to LEU was completed in the autumn of 2006. Targets to produce medical isotopes are still based on HEU, but the introduction of LEU targets is pursued and envisaged to be in use in 2017/2018. Technical details of the HFR can be found in the CNS-5 report published in September 2010 for the fifth review meeting of the CNS in April 2011.

b. History and use of HFR

The construction of the facility began in the mid-fifties at the Petten site, a location in the dunes close to the sea. The reactor core achieved criticality for the first time in 1961. In 1962, following a special request by the Dutch government, an agreement between the Dutch government and the European Community for Atomic Energy (Euratom) was signed by which it was decided that Petten would host one of the four Joint Research Centres (JRC). As a consequence of that agreement, ownership of the reactor was transferred to the European Committee for Atomic Energy (Euratom) in 1962.

Although the Joint Research Centre (JRC) Petten became the LH, the operation and maintenance of the reactor was subcontracted to the founding organisation, Reactor Centre Netherlands. This organisation was later renamed the Energy Research Foundation Netherlands (ECN). In 1998, the nuclear branches of ECN and KEMA (a former research institute of the Electric Power Utilities) were merged and the operation of the HFR was consequently transferred to the newly formed organisation NRG (Nuclear Research and consultancy Group). NRG was also granted the right to exploit the HFR commercially.

In 2002 the HFR was temporary shutdown for more than a month for safety concerns, being indications of growing weld indications and safety culture deficiencies. After independent investigations by two different organisations, one of which was an INSARR mission in 2002 by the IAEA, the reactor was allowed to restart after the realisation of

several immediate actions and the adoption of an improvement plan to be carried out in the next years. One of the advices of IAEA was the transfer of the licence from the JRC to the operator NRG, which was realised in 2005 in connection with the updated license after the first periodic safety review (see also paragraph d). Although much of the use of the reactor is still in the field of materials research, including new fuel types, the reactor is increasingly being used for medical applications i.e. radioisotopes for diagnostic purposes and patient treatments. The replacement of this reactor is foreseen in 2025, depending on the support of investors for the construction of the PALLAS reactor.

c. Modifications

From 2002 to 2005 a first periodic safety review (PSR) was executed. References were the existing IAEA rules and regulations for research reactors, complemented with some principles applied in nuclear power reactors. The design basis got newly defined by a complete set of PIE analyses. Ageing and operating experience were investigated and there was a survey of the state of the art, which included visits to other research reactors. A probabilistic risk scoping study complemented the safety analyses. The safety review resulted into a list of recommendations and suggestions. This led to a Safety Design and Modification Concept. The most important modifications were described in the aforementioned nuclear licence of 2005.

The new safety concept of the HFR is mainly based on three safety functions: safe shut-down of the reactor, long-term decay-heat removal, and containment. This concept is based on the traditional principles of defence-in-depth and multiple safety barriers for all accident conditions. In addition, a 30-minute autarchy period has been introduced during which no credit for operator intervention is taken. The safety analyses and risk scoping study being conducted within the framework of the 10-yearly periodic safety review, bearing in mind this safety concept, have produced a number of recommendations for improvements, most of which have been implemented as part of a major modification programme. Due to media and political attention, a measure to overcome the effects of a special large-break LOCA (installation of a vacuum breaker on the reactor vessel head) has been licensed separately and was implemented in late 2003. The major features of the modification programme are:

- installation of additional vacuum breakers on the primary system to prevent uncovering of the core during a large break LOCA;
- installation of Accident Pressure Equalisation lines preventing pressure built up and uncovering of the core in the event of a boiling core;
- controlled use of pool water in case of a primary leak combined with loss of power by installation of pool water injection valves; this enhances the passive safety of the plant;
- replacement of one diesel driven decay heat removal pump by an electrical pump with own battery back-up, increasing the availability of the emergency core cooling;
- modification of Emergency Power System logic;
- limitation of the portal crane movement inhibiting hoisting above the reactor vessel during reactor operation;
- a shock damping structure to prevent pool damage by a falling transport container (status; not yet implemented);
- installation of a manual operated alternative shutdown system for ATWS events;
- jackets around existing siphons in the primary cooling water system providing redundant containment isolation (this measure has later been replaced by a concept of leak detection).

The last topic has been replaced with a semi break preclusion concept with leak detection, because the original modification turned out not to be feasible. There is still one issue open: the shock damping structure.

The second PSR covering the period 2004-2013, which started in 2011 is finished, but still is under review at the ANVS. It is expected that during the CNS7 review meeting more information can be given about the measures that will be implemented.

d. Licence renewal

In 2005, with a further addition in 2007, the licence of the HFR was renewed for several reasons.

- The licence existing at that time was obsolete. It was issued before the Nuclear Energy Act entered into force and revisions so far had been fragmentary;
- Due to the first 10-yearly Periodic Safety Review the HFR needed a significant upgrade. A new updated Reference Licensing Basis and a new Safety Analysis Report (SAR) were issued in the process. In order to make the safety upgrade possible, a new licence was needed;
- The HEU-LEU conversion for the fuel elements also required a licensing procedure;
- The transfer of the licence from JRC to NRG required a new licence as well.

New licence conditions were issued by the ANVS, among others:

- The 10-yearly Periodic Safety Review are mandatory;
- Every 5 years an IAEA-INSARR mission or alike should be held;
- The allowed amount of spent fuel in the fuel storage pool, after a transition period of 3 years, is limited to 500 fuel elements. Spent fuel should be shipped as soon as possible to the waste storage facility COVRA;
- Organisational changes or changes in the mandate of the senior-managers need prior approval of the director of the ANVS;
- The reference licensing basis as developed for the 10-yearly Periodic Safety Review is part of the mandatory regulation for the HFR;
- An ageing management system has to be maintained (after having been developed);
- A system for operational feedback is institutionalised.

The HFR licence may be modified and renewed covering the modifications for the 2nd PSR.

e. IAEA-INSARR missions

In 2002 an IAEA-INSARR mission was conducted with emphasis on safety culture. Refer to the CNS-3 Dutch national report on the Convention on Nuclear Safety for a more detailed description of the safety culture issues at that time.

Prompted by the earlier identified safety culture issues as well as the recommendations of the IAEA-INSARR-mission, the inspectorate of the ANVS formulated a licence condition for the new licence, which required every 5 years an IAEA-INSARR review or equivalent independent audit to be conducted. This requirement resulted into transformation of the follow-up mission of the 2002 INSARR into a full scope new mission. This second INSARR-mission was held in 2005 and at that time it was the mission with the largest scope and the largest number of experts (10) in the team. It was noted that almost all issues identified in the 2002 INSARR mission were resolved. Special mention was made in the report on the implementation of the Safety Culture Enhancement Plan, that succeeded to resolve most of the pending safety issues and followed the recommendations and suggestions provided by the INSARR mission of 2002.

In 2008 the ANVS carried out its own safety culture audit, followed up in 2012. The conclusion was that not in all areas improvements were visible and that some old weaknesses were still unsolved. The LH will continue working on safety culture improvement and both RB and LH have agreed to have in the future annual meetings about plans and progress.

The next INSARR mission was done in 2011. Its results will be followed up in the INSARR mission in 2016. In 2017 there will be a ISCA mission and finally in 2017/2018 there will be an LTO-mission. All will be followed up in the INSARR mission in 2021.

f. Tritium leakage to the environment

Based on a recommendation from a IAEA mission in 2010, five groundwater measurements points (wells) were installed at the site around the HFR. In one of these, a level of 50 Bq/l was detected in 2010. In 2011 again a low level of tritium was detected, and in april 2012 a higher level of 230 Bq/l . More and deeper positioned measuring points (up to 200) were installed to find the cause. Levels up to 175kBq/l were detected in oktober 2012. In November 2012 the origin of the sources was found.

It was discovered that underground aluminium-piping between different buildings were degraded. The affected pipeline is part of a system that is only used during maintenance periods when water from the reactor basin is pumped temporarily into a storage tank⁹¹. The area of groundwater contamination was determined to have a length of 125 m and a width of 25 m and a maximum depth of 10 m. January 2013 the complete remediation of the area started and in July 2016 it is ongoing. There is no impact on the public health, but the situation is closely monitored.

g. Primary system leakage and repair

In December 2012 a leakage was detected between the primary system and the fuel pool cooling system (seal leakage from the bottom plug). The reactor was kept out of operation to find the cause and a solution of the problem. Because a simple repair was not possible, a modification, in fact extension of the primary system was proposed by the LH. The RB agreed on this modification, and after its implementation, the reactor started up in June 2013.

⁹¹ During the repair of the damaged pipeline, an alternative pipeline available for use during maintenance shutdowns, served as a temporary replacement.

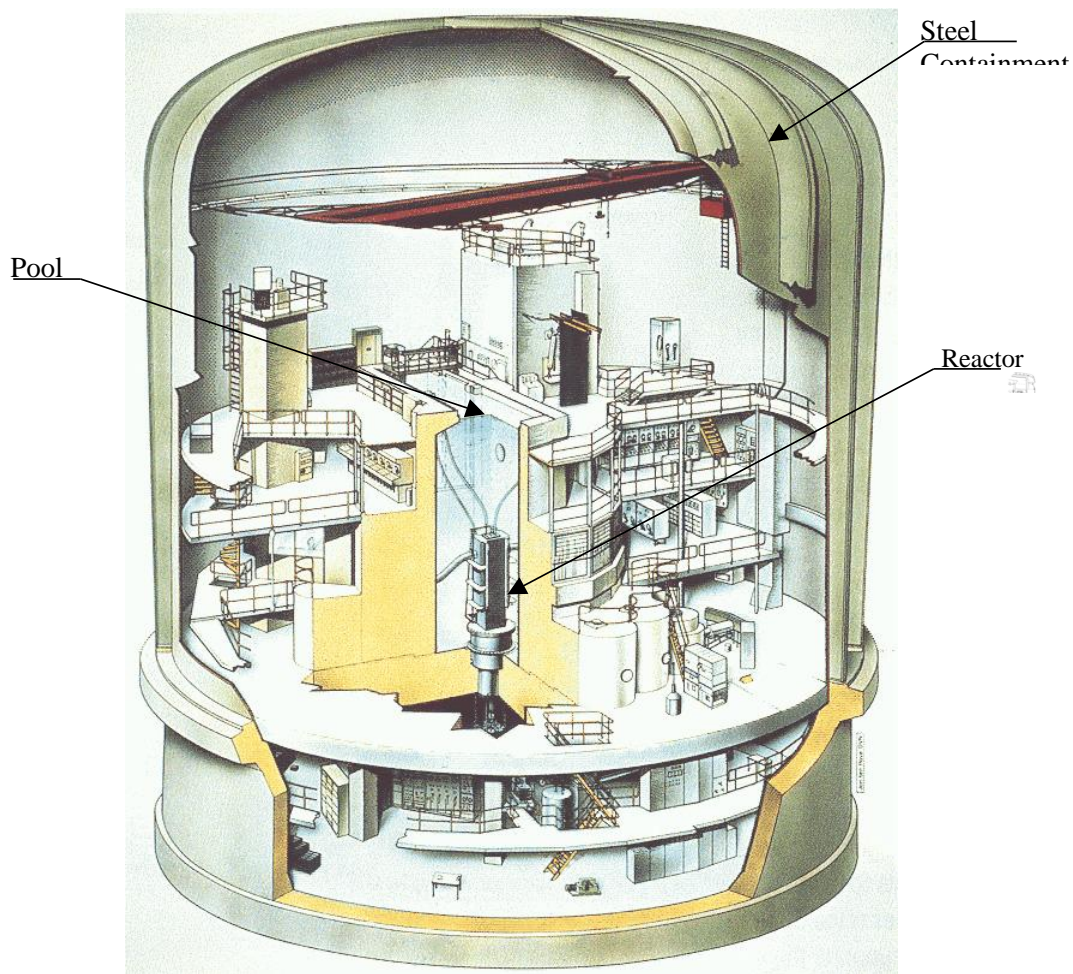

Figure 14 3D Cross section of reactor building of the HFR

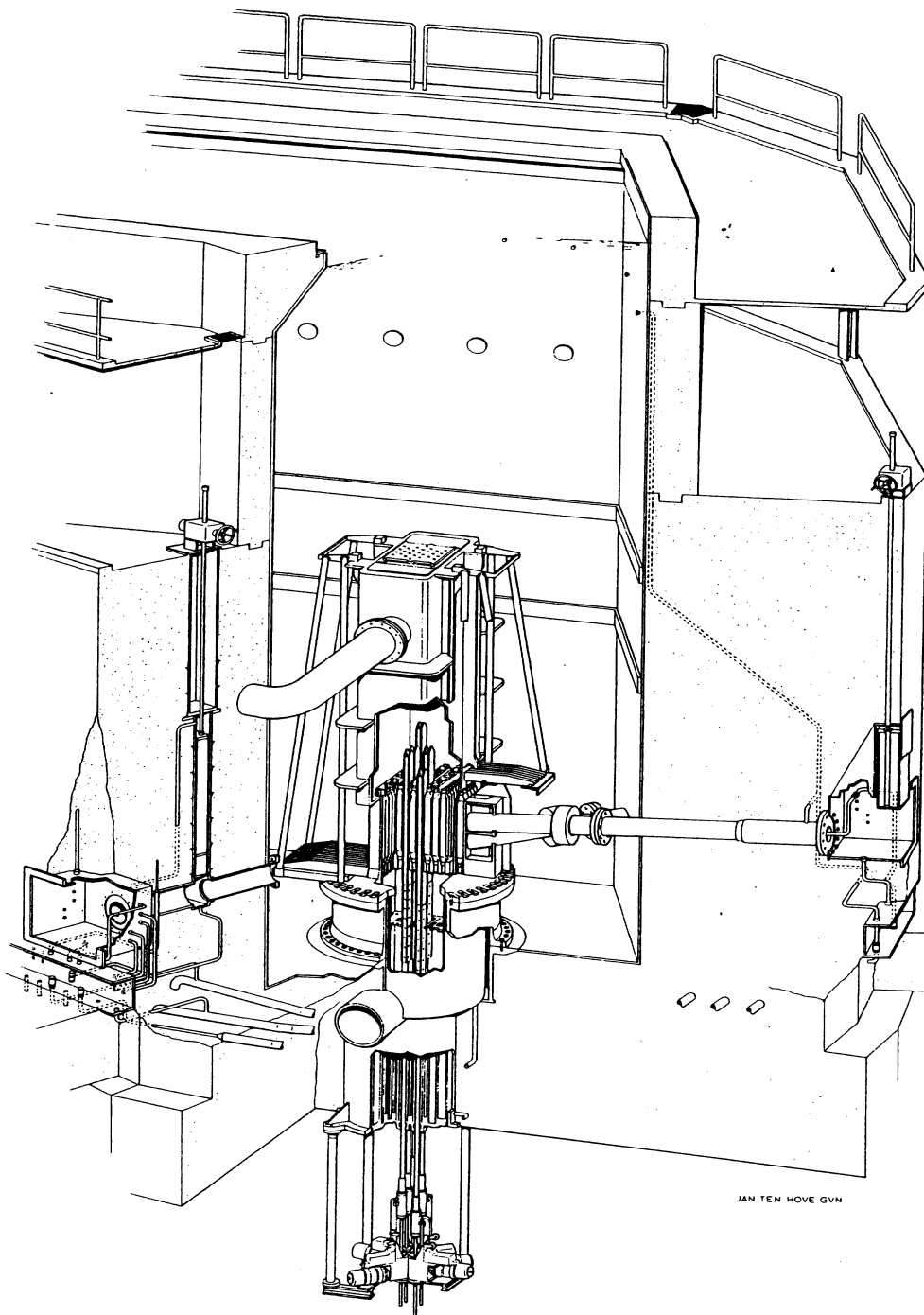

Figure 15 Reactor vessel in reactor pool of the HFR

Appendix 8 Missions to Nuclear Installations and the RB

This appendix gives some information on the findings of the missions to the Borssele NPP since the CNS6 report: the SALTO2014 (follow-up) and OSART2014 mission. It should be noted that the follow-up of the OSART2014 will be in two stages: end of 2016 and end of 2017. In addition information is given on the 2014 IRRS-mission findings. The follow-up will be in 2018.

a. SALTO 2014 Follow-up on SALTO 2012 (including some open issues from SALTO 2009)

The results of the SALTO2012 mission can be found in the CNS6 report.

Borssele NPP was required to perform an LTO assessment to demonstrate the safety of the plant for 60 years of operation. This SALTO mission is in support of and has reviewed details related to this LTO assessment. The scope of the SALTO missions was agreed to and defined in Terms of Reference issued in July 2009.

The follow-up mission was performed during 4–7 February 2014.

During the original full scope SALTO peer review mission in 2012, fifteen issues were defined in six reviewed areas. The follow-up team reviewed the progress in issues solving separately for each of those issues and also separately for each recommendation and suggestion contained in issue sheets (except of issues from area "Management, Organization and Administration OSART Module" which were going to be reviewed by the planned OSART mission in September 2014). Progress in solving of A3 and C1 issues of "A Limited-scope SALTO Peer Review Mission (2009)" was also evaluated.

The 14 out 15 issues were closed (4) or closed with satisfactory progress (10), including the two open issues from 2009 which were closed with satisfactory progress. The only issue that was still unsatisfactory was the "Plant programmes for ageing management are not documented in a systematic way". In the meantime it has been verified that this issue has been solved.

The report was published and can be found under:

<http://www.autoriteitnvs.nl/documenten/rapport/2016/06/14/salto-peer-review-mission-for-borssele-nuclear-power-plant-in-the-netherlands>.

Based on the experience with the SALTO-mission ANVS has now requested IAEA for developing and realizing a similar mission to the Research Reactor in Petten in 2017. After that ANVS will consider to apply such a mission also to the Research Reactor at TU Delft.

b. OSART 2014 mission findings

Every 10 years there will be an OSART mission to the NPP Borssele. The 3rd mission was done in 2014 (1-18th of September 2014), one year ahead of the original plan in order to comply with the recommendation for older reactors to carry out an OSART within three years after the publication of the IAEA Actionplan.

The purpose of the mission was to review:

- Corporate functions in the areas of corporate management, support to provide human resources, independent oversight, communication;
- Operating practices in the areas of Management, organisation and administration; Training & qualification; Operations; Maintenance; Technical support; Operating

experience; Radiation protection; Chemistry; Emergency planning and preparedness; and Severe accident management;

- The safety culture of the organization, using different methods to gather data such as questionnaire, interviews, focus groups.

The conclusions are based on the plant's performance compared with best international practices. The following areas of good performance, including the following:

- EPZ has a risk management officer who is responsible for development and control of integral risk management within the organization of EPZ. Integral risk management is the umbrella for all types of risks;
- The establishment of Young EPZ Professionals as a response to rapid demographic changes;
- Process maturity model for monitoring the progress and improvement of the integrated management system;
- The plant organizes six site-wide integrated exercises each year to ensure that all personnel with assigned duties during an emergency participate in an exercise each year;
- Requirements for Severe accident management (SAM) equipment in separate Plant Technical Specifications.

The team found also a number of areas in need of improvement to enhance operational safety performance. The most significant ones include the following:

- Leadership for safety is not recognized throughout the organization to ensure sustainable safety performance;
- The change management process is not effectively used to support changes in the organization;
- An effective Human Performance Programme has not been implemented;
- Expectations are not systematically being met by plant personnel nor reinforced by managers and supervisors, and some of them are not yet set;
- The plant's expectations and work management process are not robust enough to ensure effective personnel resource usage, completion of risk reviewed work, and safe work schedule stability;
- High standards of material condition in some plant areas are not consistently maintained;
- The process for temporary modifications does not provide adequate arrangements for their review, approval or control, to ensure that temporary modifications are handled in a safe manner;
- Analysis for some events has not been performed adequately to ensure that the root cause is identified and are not consistently completed in a timely manner;
- The plant workers and line management do not always take responsibility for ensuring their own or team's radiation protection and are not held accountable when the required radiation protection behaviours and work practices are not achieved;
- The on-site emergency arrangements are not sufficient to ensure the timely protection of on-site workers in the event of an emergency;

- The plant’s abnormal operation procedures and EOPs are incomplete and do not address the scope of all credible plant states.

The report has been published and can be found on:

<http://www.autoriteitnvs.nl/documenten/rapport/2015/5/11/team-osart-mission-to-the-epz-borssele>

c. IRRS 2014 mission findings

An international team of 20 safety and radiation protection experts and 5 IAEA staff members met with representatives of the Ministry of Economic Affairs (EZ), the Ministry of Health, Welfare and Sport (VWS) and the Ministry of Infrastructure and Environment (I&M) of the Netherlands from 3 to 13 November 2014.

Special attention was given to regulatory implications in the national framework for safety of the TEPCO-Fukushima Daiichi accident. The IRRS mission covered all nuclear and radiological facilities and activities regulated by the Netherlands. IRRS team members observed inspections at various facilities. The IRRS team did not find an important issue related to implications of the TEPCO Fukushima Daiichi accident. The IRRS team observed that all Dutch counterparts were committed to provide as good as possible regulatory functions covering a small but complex and diverse nuclear programme and a diverse range of activities with radioactive sources in the country. The IRRS team found that the main challenge was a consolidation of several authorities into the single independent administrative authority.

The good practices identified by the IRRS team are the Dutch system for protection from orphan sources of ionizing radiation in scrap metal and the regulatory body’s initiative to create an international forum of nuclear regulators of countries operating nuclear power plants of German origin.

The IRRS team identified certain issues warranting attention or in need of improvement and believes that consideration of these would enhance the overall performance of the regulatory system. Most important are:

- National policies on nuclear and radiation safety, radioactive waste management and associated financial provisions for decommissioning and disposal should be consolidated with a special emphasis on assuring sustainability of human resources in the future.
- The new regulatory body should ensure that its structure and organization promote a common safety culture which will enable regulatory functions to be discharged in an integrated and coordinated manner.
- The regulatory body should be assured independence from undue political influence. The communication and cooperation between different parts of the regulatory body should be enhanced. Sufficient resources should be made available.
- The integrated management system of the regulatory body should be finalized and should include descriptions of all relevant processes, systematic training and qualification of regulatory staff, consolidation of the various safety-related records systems and document management systems.
- The regulatory body should further develop and periodically review regulations and guides to improve consistency, clarity and transparency in the licensing processes of the different facilities and activities and to strengthen the regulatory framework in the area of emergency preparedness and response as well as patient and public protection.

- Inspections should be systematically planned and prioritized. Inspection findings should be effectively tracked and the effectiveness of enforcement should be periodically reviewed.

The IRRS team noted that the Dutch Council of Ministers decided on 24 January 2014 that the expertise in the area of nuclear safety and most of the expertise on radiation protection will be brought together in a single new administratively independent authority. In fact from January 1st, 2015 the new organization started as the Authority for Nuclear Safety and Radiation Protection (ANVS). It is expected that the law to establish the administrative independence will enter into force by January 1st 2017. The IRRS report can be found at http://www.autoriteitnvs.nl/documenten/publicatie/2015/5/1/irrs_to_the_netherlands.

Appendix 9 Post-Fukushima Daiichi measures

The following two tables present the post-Fukushima Daiichi actions in the Netherlands. They have been reproduced from the Netherlands' NAcP and updated to reflect the situation on July 1st 2016.

Table 5 National post-stress test Actions – initiated by (or imposed by RB) on LH (operator of one NPP unit) – Status April 2016

NL Action No.	Topic	Action / Activity	Related Recommendation No. on European Level	Status	Finalization
1 (M1)	SAM	Emergency Response Centre (ERC) - study and consider options to better protect ERC like alternative location ERC, new building, strenghtening current building etc.	1, 8, 22, 27, 32, 44	in progress	2017
2 (M2)	SAM	Storage facilities for portable equipment (needed for accident management), study and consideration of options to improve resistance against external hazards	1, 8, 27, 32, 44	partially implemented, finalisation in progress	2017
3 (NR 7.3.1)	design issues	Improvement of accessibility under extreme conditions	32, 44	study finalised	2015
4 (PR 4.2.4.2)	SAM	Analysis of potential doses to workers	22, 32, 43, 44	analysis finalised	2014
5 (NR 6.1.5)	SAM	Reassessment of ERO Staffing regarding its adequacy 24/7	35	finalised	2014
6 (M3)	SAM	A possibility for refilling the spent fuel pool without entering the containment - this will increase the margin to fuel damage in certain adverse containment conditions.	23	implemented	2014

APPENDIX 9 POST-FUKUSHIMA DAIICHI MEASURES

NL Action No.	Topic	Action / Activity	Related Recommendation No. on European Level	Status	Finalization
7 (M4)	SAM	Additional possibilities for refilling the spent fuel pool - this will increase the number of success paths and therefore increase the margin to fuel damage in case of prolonged loss of spent fuel pool cooling.	23	in progress	2017
8 (NR 7.3.1)	SAM	Improvement of possibilities to sustain cooling SFP - <i>this is covered under action 6 and 7 (M3 and M4).</i>		refer to 6 and 7	
9 (M5)	SAM	Reduction of the time necessary to connect the mobile diesel generator to Emergency Grid 2 to 2 hours - this will increase the margin in case of loss of all AC power supplies including the SBO generators.	15, 26	in progress	June 2016
10 (M6)	SAM	Establishing ability to transfer diesel fuel from storage tanks of inactive diesels to active diesel generators. Phase 1: emergency grid 1 EDGs, Phase 2: remaining diesels.	15, 17	implemented	mid-2014
11 (M7)	SAM	Establishing independent voice and data communication under adverse conditions, both on-site and off-site, would strengthen the emergency response organisation. Includes evaluation current means, procurement satellite communication apparatus, and arrangements with Ministry of Defence.	35	implemented	end-2013
12 (M8)	Ext Events / Nat Hazards	Ensuring the availability of fire annunciation and fixed fire suppression systems in vital areas after seismic events - this will improve fire fighting capabilities and accident management measures that require transport of water for cooling/suppression.	7, 32	in progress	studies mid-2014 impl's2017

APPENDIX 9 POST-FUKUSHIMA DAIICHI MEASURES

NL Action No.	Topic	Action / Activity	Related Recommendation No. on European Level	Status	Finalization
13 (NR 7.3.1)	design issues	Quality fire fighting systems buildings 01/02 and 35 for a DBE. <i>This is covered under action 12 (M8).</i> [The fire fighting systems in buildings 01/02 (dome) and 35 (backup control room) are not designed for operability after occurrence of the design base earthquake (DBE). To enhance their reliability after a DBE they should be qualified. However, any enhancement should be based on the results of the proposed advanced seismic analysis. This position is linked to LH's proposal S3 (Action 33) but also (for implementation) to its measure M8 (Action 12).]		refer to 12	
14 (M10)	Ext Events / Nat Hazards	Ensuring the availability of the containment venting system TL003 after seismic events - this will increase the margin in case of seismic events.	3, 31, 32, 48	in progress, refer to 33 - 35	studies end-2013 impl's 2017
15 (NR 7.3.1)	design issues	Technical and organisational improvement of availability under earthquake conditions of systems for containment filtered venting and fire fighting - should be based on results of advanced seismic analysis. <i>This is covered in actions 12 (M8) and 14 (M10).</i>		refer to 14 & 12	
16 (M9)	design issues	Increasing the autarky-time beyond 10 h - this will increase the robustness of the plant in a general sense.	16	in progress	studies end-2012 impl's 2017
17 (NR 7.3.1)	design issues	Increasing the autarky time beyond 10 hours (M9). Further study to define its proper implementation. <i>This is covered in action 16 (M9).</i>		in progress	2017

APPENDIX 9 POST-FUKUSHIMA DAIICHI MEASURES

NL Action No.	Topic	Action / Activity	Related Recommendation No. on European Level	Status	Finalization
18 (M11)	Ext Events / Nat Hazards	Wave protection beneath the entrances to the bunkered back-up injection- and feedwater systems and to the bunkered emergency control room - this will mitigate the sensitivity to large waves combined with extreme high water and will make the plant fully independent from the dike.	8	finalised	mid-2013
19A (P1)	SAM	Develop set of EDMGs and implement training program (phase 1, procurement 1 st batch of mobile equipment)	17, 27, 29, 30, 32, 45	implemented	end-2013
19B (P1)	SAM	Develop set of EDMGs and implement training program (phase 2, EDMGs and procurement additional equipment)		in progress	end-2016
20 (NR 7.3.2)	SAM	Developing set of EDMGs - This is covered in action 19B		refer to 19B	
21 (P2)	SAM	Training of the procedure to ensure water supply during mid-loop operation and loss of AC power	19	implemented	end-2014
22 (PR 3.3)	SAM	Prepare and validate capabilities to cope with SBO during mid-loop operation.	19	in progress	study end-2012 impl's 2017
23 (P3)	Ext Events / Nat Hazards	Develop check-lists for plant walk-downs and the necessary actions after various levels of the foreseeable hazards		implemented	2015
24 (NR 6.1.5)	SAM	Training of long term SAMG measures	34, 47	in progress	end 2016
25 (PR 4.2.2.2)	SAM	Develop specific SAMG for SFP	34, 47	in progress	SAMG finalised by LH 2014, discussion reg implementation 2016

APPENDIX 9 POST-FUKUSHIMA DAIICHI MEASURES

NL Action No.	Topic	Action / Activity	Related Recommendation No. on European Level	Status	Finalization
26 (PR 4.2.4.2)	SAM	Improvement of SAMGs and EOPs focusing on long term accidents. Operator EPZ will also become member of the Westinghouse Owner Group	33, 34, 47	in progress	2016
27A (NR 7.3.2)	SAM	Assessment of the need to upgrade equipment and/or instrumentation dedicated to SAM purposes (hardened core approach). Part A includes: study increasing robustness existing equipment & study protection of equipment against BDB extreme hazards	1, 17, 18, 32, 33, 47	in progress (relation with 33 – 35)	2017
27B (NR 7.3.2)	SAM	Assessment of the need to upgrade equipment and/or instrumentation dedicated to SAM purposes . Part B includes study of accessibility of locations for manual operation, including relocation options.	1, 17, 18, 29, 32, 33	in progress (relation with 33 – 35)	2017
27C (NR 7.3.2)	SAM	Assessment of the need to upgrade equipment and/or instrumentation dedicated to SAM purposes. Part C includes study of periodic test/inspection programs for equipment & of well defined and trained procedures to use the equipment.		in progress (relation with 33 – 35)	2017
28 (NR 7.3.2)	SAM	Develop set of clear criteria to provide a basis for deciding when to switch the turbine oil pump off to increase the battery time. Disabling this pump will damage the turbine		implemented	2013
29 (S1)	SAM	Study of a reserve SFP cooling system independent of power supply. This is also addressed in action 7 (M4).	19, 23	in progress	study end-2013 impl's end-2016
30 (S2)	Ext Events / Nat Hazards	Investigate measures to further increase the safety margins in case of flooding (survey & analysis). When needed, proposal for modifications and	13	finalised	2014

APPENDIX 9 POST-FUKUSHIMA DAIICHI MEASURES

NL Action No.	Topic	Action / Activity	Related Recommendation No. on European Level	Status	Finalization
		implementation.			
31 (NR 7.3.3)	Ext Events / Nat Hazards	Study flooding - this is covered by action 30 (S2).		refer to 30	
32 (PR 2.3.3)	Ext Events / Nat Hazards	Study super storms - this is covered by action 30 (S2).		refer to 30	
33 (S3)	Ext Events / Nat Hazards	Study Seismic Margin Assessment, this includes various studies: Study SMA and SPSA methods Evaluation KNMI: Recommendation study 'Seismic Hazard in context IAEA' Drafting of proposal SMA Determining RLE Undertake SMA	7, 13, 23	in progress	2017
34 (NR 7.3.3)	Ext Events / Nat Hazards	Study SMA - this is covered by action 33 (S3)		refer to 33	
35 (PR 2.1.3)	Ext Events / Nat Hazards	Consider update hazard assessment, including DBE and liquefaction. <i>This is covered by action 33 (S3)</i>		refer to 33	
36 (S4)	design issues	Study on strengthening off-site power supply, includes studies and when needed implementation.	15	in progress	2017
37 (S5)	design issues	Study more extensive use of steam for powering an emergency feed water pump; includes studies and when needed implementation.	15	finalised	2015
38 (S6)	Ext Events	Study impact aircraft impact on safety functions		in progress	2017

APPENDIX 9 POST-FUKUSHIMA DAIICHI MEASURES

NL Action No.	Topic	Action / Activity	Related Recommendation No. on European Level	Status	Finalization
39 (S7)	design issues	Study hydrogen threat to containment. The NPP has ample provisions to deal with this threat. Nevertheless additional studies will be undertaken.	31	in progress	2017
40 (NR 7.3.3)	External Events	Water accumulation if drain pipes are blocked during fire fighting; studies and when needed implementation of measures. The studies will also cover prevention of freezing of underground piping, other weather related hazards.		finalised	mid-2014
41 (PR 2.3.3)	External Events	Study freezing of underground piping, operation of diesels in cold conditions, effects of snow. <i>This is covered in action 40.</i>		refer to 40	
42 (NR 5.1.5)	SAM	Study amount of lubrication oil (for diesels) in crisis situations	17	finalised	2013
43 (NR 5.1.5)	design issues	Re-assessment of alternative power sources (alternative to emergency grids). This includes planning and implementing extra external connection points for mobile diesel generator and the fire fighting system (water supply)	15, 16, 22, 26	in progress	2016
44 (PR 4.2.4.2)	SAM	Better arrangements for mobile diesel generators and batteries. This includes study of small emergency power generators or fuel cells as a means for recharging or backup power. Possibly also instructions for recharging or switching to such power sources.	16, 22, 26	in progress	2017
45 (NR 6.4.3)	SAM	Study of procedures for handling of large amounts of radioactively contaminated water. Includes study & when needed implementation.		finalised	2015
46 (PR 4.3)	SAM	Unambiguous tagging of keys of rooms in bunkered building (ECR). Keys will be numbered and the necessity of having SAMG documentation in the ECR will be evaluated.		implemented	2012

Table 6 National post-stress test Actions – acting on and initiated by the national RB

NL Action No.	Topic	Action / Activity	Related Recommendation No. on European level	Status	Finalization
RB-4.001	national organisation	The RB is drafting requirements for the design and construction of new nuclear reactors - they will be implemented in the regulatory framework.	101	finalised	2015
RB-4.002	national organisation	The RB is in the process of drafting requirements related to internal & external hazards - they will be implemented in the regulatory framework.		finalised	2015
RB-4.003	national organisation	The RB is studying new financing mechanisms for handling of licence applications and supervision.	102	finalised	2014
RB-4.004	national organisation	RB evaluation in the framework of the IRRS self assessment and coming IRRS mission. In the self-assessment the RB will take notice of the xCNS summary 'Action oriented objectives for strengthening Nuclear Safety'.	102	finalised	2014
RB-4.005	national organisation	Consequences of German phase out. The Dutch RB will study the possible long term impact of the German phase out on the operation of the German-design Dutch NPP. The Dutch RB will evaluate the possibility to increase exchange information with other regulators of German design plants like Spain and Switzerland.	131	Study of impact in progress. Exchange of information in 'KWU club'	2016 2013
RB-4.006	national organisation	In the light of the self-assessment within the framework of the IRRS-mission special attention will be paid to explain the management of Safety Culture within the Regulatory Body.	135	finalised	2014

APPENDIX 9 POST-FUKUSHIMA DAIICHI MEASURES

NL Action No.	Topic	Action / Activity	Related Recommendation No. on European level	Status	Finalization
RB-4.007	national organisation	The Netherlands are implementing the IAEA action plan. A number of actions are already practice, like the adoption of the IAEA-regulations, the IAEA missions, and evaluation and strengthening of EP&R.		in progress	no end date
RB-4.008	national organisation	Taking into account the European developments on this matter, research is in progress into clearance levels and protocols for measurement, decontamination and clearance, applicable to clearance of containers and other materials		finalised, related to RB-4.012	2013
RB-4.009	national organisation	Implementation in the Dutch regulations of the update of the WENRA RL for existing reactors as published in September 2014 and based on the Fukushima Lessons Learned		In progress	2017
RB-4.010	national organisation	Implementation in the NPP of the update of the WENRA RL for existing reactors as published in September 2014 and based on the Fukushima Lessons Learned		In progress	2020
RB-4.011	national organisation	Implementation in the regulatory framework of the EU Nuclear Safety Directive published in 2014		In progress	2017
RB-4.012	national organisation	To establish guidance for LHs on clearance of materials, buildings and sites in decommissioning projects.		Finalised	2014
RB-5.001	EP&R	Planning and organisation of bilateral exercises with Belgium and Germany is ongoing.	111	in progress	no end date

APPENDIX 9 POST-FUKUSHIMA DAIICHI MEASURES

NL Action No.	Topic	Action / Activity	Related Recommendation No. on European level	Status	Finalization
RB-5.002	EP&R	Damage to infrastructure (hampering EP&R activities) is subject to renewed evaluation in the light of post-Fukushima learning	108	in progress	no end date
RB-5.003	EP&R	Study alternative means of communication for RB staff visiting a potential crisis area with disturbed communication infrastructure.		In progress	2016
RB-6.001	international cooperation	Drafting and publishing national report for CNS 2014		Completed	August 2013
RB-6.002	international cooperation	EU/ENSREG, participation in Peer Review Workshop regarding National Action Plans (post Fukushima measures)		Completed	April 2013
RB-6.003	international cooperation	EU/ENSREG, participation in workshops 'Natural Hazards' and 'Emergency response', publication guidance documents planned for review.		Completed	Nat Haz, June 2013 Em zones, March 2013
RB-6.004	international cooperation	Harmonisation effort with neighbouring countries regarding emergency countermeasure zones (and associated intervention levels) and responses		Completed	2014
RB-6.005	international cooperation	Two workshops of Dutch RB with peers in Belgium (FANC)		Completed	2013
RB-6.006	international cooperation	Collaboration in international forums is continued	101	in progress	no end date
RB-6.007	international cooperation	cooperation with foreign TSOs		in progress	no end date
RB-6.008	International cooperation	Regarding improvement of regulatory experience feedback, implement IRRS recommendations before IRRS followup mission		Ongoing	2018

Appendix 10 Response on Observations and Lessons in DG's Report on the Fukushima Daiichi Accident

Table 7 Response of the Netherlands on 'Observations and lessons – DG's Report on the Fukushima Daiichi Accident'

Sect.	Title	Section title	Key message	Background	Action Netherlands
2	Safety Assessment	Vulnerability of the plant to external events	The assessment of natural hazards needs to be sufficiently conservative. The consideration of mainly historical data in the establishment of the design basis of NPPs is not sufficient to characterize the risks of extreme natural hazards. Even when comprehensive data are available, due to the relatively short observation periods, large uncertainties remain in the prediction of natural hazards.	Extreme natural events that have a very low probability of occurrence can result in significant consequences, and the prediction of extreme natural hazards remains difficult and controversial due to the existence of uncertainties. Additionally, such predictions may change during the life of an NPP as more information becomes available and methods of analysis improve. It is therefore necessary to use all relevant available data, both domestic and international, to ensure a reliable prediction of hazards, to define a reliable and realistic design basis against natural extreme events, and to design NPPs with sufficient safety margins.	European CSA (i.e. stress test) has been carried out, including an updated analysis of natural hazards. Updated 2014 WENRA Reference levels related to external natural hazards will be implemented.

APPENDIX 10 DG's REPORT ON THE FUKUSHIMA DAIICHI ACCIDENT - OBSERVATIONS AND LESSONS

Sect.	Title	Section title	Key message	Background	Action Netherlands
2	Safety Assessment	Vulnerability of the plant to external events	The safety of NPPs needs to be re-evaluated on a periodic basis to consider advances in knowledge, and necessary corrective actions or compensatory measures need to be implemented promptly.	The periodic safety review programme at the Fukushima Daiichi NPP did not lead to safety upgrades based on regulatory requirements. TEPCO performed the re-evaluation on a voluntary basis considering advances in knowledge, including new information and data. When faced with a revised estimate of a hazard that exceeds previous predictions, it is important to ensure the safety of the installation by implementing interim corrective actions against the new hazard estimate while the accuracy of the revised value is being evaluated. If the accuracy of a new hazard estimate is confirmed, the operating organization and regulatory authority need to agree on a schedule and comprehensive action plan to promptly address the method of coping with such higher hazards to ensure plant safety.	European Nuclear Safety Directive 2009, updated 2014, requires the continuous improvement of safety, including the instrument Periodic Safety Review. Periodic Safety Review has been applied to Dutch only NPP (Borssele) since over 25 years ago. External hazards has been part of it since many years.

APPENDIX 10 DG's REPORT ON THE FUKUSHIMA DAIICHI ACCIDENT - OBSERVATIONS AND LESSONS

Sect.	Title	Section title	Key message	Background	Action Netherlands
2	Safety Assessment	Vulnerability of the plant to external events	The assessment of natural hazards needs to consider the potential for their occurrence in combination, either simultaneously or sequentially, and their combined effects on an NPP. The assessment of natural hazards also needs to consider their effects on multiple units at an NPP.	The Fukushima Daiichi accident demonstrated the need to fully investigate the potential for a combination of natural hazards affecting multiple units at an NPP. The complex scenarios resulting from the occurrence of a combination of natural hazards need to be taken into account when considering accident mitigation measures and recovery actions.	The assessment of combinations of natural hazards was part of the CSA and will also be implemented by the updated 2014 WENRA RL. Multiple units does not apply.
2	Safety Assessment	Vulnerability of the plant to external events	Operating experience programmes need to include experience from both national and international sources. Safety improvements identified through operating experience programmes need to be implemented promptly. The use of operating experience needs to be evaluated periodically and independently.	The operating experience evaluation programme at the Fukushima Daiichi NPP did not lead to design changes that took account of domestic or international experience involving flooding. The review of operating experience needs to be a standard part of plant oversight processes, with account taken of relevant sources such as the Incident Reporting System of the IAEA and the OECD Nuclear Energy Agency. Regulatory bodies need to perform independent reviews of national and international operating experience to confirm that operating organizations are taking concrete actions to improve safety.	The Dutch NPP has a comprehensive OEF-programme using national and international sources. It is a member of WANO. Every 4 years a WANO Peer Review is carried out, that also looks at the OEF. The ANVS requires the OEF programme and reporting. ANVS inspects the OEF-programme and reports about it to the Dutch parlement annually. Every 10 years an OSART-mission is carried out, that also looks at OEF.

APPENDIX 10 DG's REPORT ON THE FUKUSHIMA DAIICHI ACCIDENT - OBSERVATIONS AND LESSONS

Sect.	Title	Section title	Key message	Background	Action Netherlands
2	Safety Assessment	Application of the defence in depth concept	The defence in depth concept remains valid, but implementation of the concept needs to be strengthened at all levels by adequate independence, redundancy, diversity and protection against internal and external hazards. There is a need to focus not only on accident prevention, but also on improving mitigation measures.	The flooding resulting from the tsunami simultaneously challenged the first three protective levels of defence in depth, resulting in common cause failures of equipment and systems. Even when faced with this situation, operators were able to apply effective, albeit delayed, mitigation strategies. All layers of defence in depth associated with both prevention and mitigation of accidents should be strengthened by adequate independence, redundancy, diversity and protection so that they are not simultaneously challenged by an external or internal hazard and are not prone to common cause failure. The application of the defence in depth concept needs to be periodically re-examined over the lifetime of an NPP to ensure that any change in vulnerability to external events is understood and that appropriate changes to the design are made and implemented. There is a need for extreme external hazards to be addressed in periodic safety reviews, because such hazards can result in common cause failures that may simultaneously jeopardize several levels of defence in depth.	The measures following the CSA reinforce the DiD of the NPP. Implementation will be completed by 2017. Addressing extreme natural hazards in PSR will be implemented through the updated 2014 WENRA RL, the EU Directive on nuclear safety (which more or less also covers the Vienna Declaration). Action: in addition to the reassessment, the Netherlands sees room for improvement within the inspection strategy.

APPENDIX 10 DG's REPORT ON THE FUKUSHIMA DAIICHI ACCIDENT - OBSERVATIONS AND LESSONS

Sect.	Title	Section title	Key message	Background	Action Netherlands
2	Safety Assessment	Application of the defence in depth concept	Instrumentation and control systems that are necessary during beyond design basis accidents need to remain operable in order to monitor essential plant safety parameters and to facilitate plant operations.	The loss of instrumentation and control during the accident at the Fukushima Daiichi NPP left operators with little indication of actual plant conditions. The loss of instrumentation and control systems had a serious impact on efforts to prevent a severe accident or to mitigate its consequences. The extent and nature of the necessary instrumentation and control systems need to be defined with care, according to the characteristics of the design of the plant, including spent fuel pools. Systems need to be protected to ensure they are available when needed. This also demonstrated the need to improve strategies to allow for manual control of vital equipment.	Implementation of CSA measures will take care of this issue.
2	Safety Assessment	Assessment of the failure to fulfil fundamental safety functions	Robust and reliable cooling systems that can function for both design basis and beyond design basis conditions need to be provided for the removal of residual heat.	At the Fukushima Daiichi NPP, the operators were eventually, after some delay, able to deploy portable equipment to inject water into the reactors. Cooling systems based either on installed or portable equipment need to be qualified and tested to ensure that they function and can be deployed by operators when needed.	Implementation of CSA measures will take care of this issue.

APPENDIX 10 DG's REPORT ON THE FUKUSHIMA DAIICHI ACCIDENT - OBSERVATIONS AND LESSONS

Sect.	Title	Section title	Key message	Background	Action Netherlands
2	Safety Assessment	Assessment of the failure to fulfil fundamental safety functions	There is a need to ensure a reliable confinement function for beyond design basis accidents to prevent significant release of radioactive material to the environment.	At the Fukushima Daiichi NPP, the failure of venting the containment, and the subsequent failure of the reactor building due to the hydrogen explosion, led to a significant release of radioactive material to the environment. The confinement function needs to be assessed to ensure that all possible hazards are considered in the design of equipment intended to maintain the integrity of the confinement system.	Implementation of PSR measures like PARs and filtered venting have been done more than 20 years ago. In addition a new In-Vessel Retention strategy will be implemented in the near future (2017) as a PSR/CSA measure.
2	Safety Assessment	Assessment of beyond design basis accidents and accident management	Comprehensive probabilistic and deterministic safety analyses need to be performed to confirm the capability of a plant to withstand applicable beyond design basis accidents and to provide a high degree of confidence in the robustness of the plant design.	Safety analyses can be used both to evaluate and to develop response strategies for beyond design basis accidents and may include the use of both deterministic and probabilistic methods. The probabilistic safety assessment studies conducted for the Fukushima Daiichi NPP were of limited scope and did not consider the possibility of flooding from internal or external sources. The limitations in these studies contributed to the limited scope of accident management procedures available to the operators.	This is covered. The safety analyses are deterministic and probabilistic. Design and beyond design accidents conditions are considered. The PSA is L1, L2 and L3, shutdown, intermediate and full power and contains a.o. fire, internal and external flooding. During PSR's new insights of deterministic analyses are assessed. A license requirement exists to keep the PSA state-of-the-art. Regularly IPSART missions are applied (Last IPSART was in 2010 and the IPSART FU was in 2013, with additional attention to Fukushima Lessons learned).

APPENDIX 10 DG's REPORT ON THE FUKUSHIMA DAIICHI ACCIDENT - OBSERVATIONS AND LESSONS

Sect.	Title	Section title	Key message	Background	Action Netherlands
2	Safety Assessment	Assessment of beyond design basis accidents and accident management	Accident management provisions need to be comprehensive, well designed and up to date. They need to be derived on the basis of a comprehensive set of initiating events and plant conditions and also need to provide for accidents that affect several units at a multi-unit plant.	The accident management procedures available to the operators at the Fukushima Daiichi NPP did not consider the possibility of a multi-unit accident, nor did they provide guidance for the complete loss of electrical power. Accident management provisions need to be based on a plant specific analysis performed by using a combination of deterministic and probabilistic methods. Accident management guidance and procedures need to consider the possibility of events taking place in several units simultaneously and in spent fuel pools. They also need to take into account the possibility of disrupted regional infrastructure, including serious deficiencies in communication, transport and utilities. Accident management provisions should also take into consideration the best available guidance from the international community and be periodically updated to account for new information.	AM and SAMG procedures have been implemented about 20 years ago. They are based on international experience (IAEA, Westinghouse, AREVA). These procedures are further improved through PSR's and the recent CSA measures and available for shutdown and full power. Also the fuel pool will be covered as well as well as disrupted infrastructure.

APPENDIX 10 DG's REPORT ON THE FUKUSHIMA DAIICHI ACCIDENT - OBSERVATIONS AND LESSONS

Sect.	Title	Section title	Key message	Background	Action Netherlands
2	Safety Assessment	Assessment of beyond design basis accidents and accident management	Training, exercises and drills need to include postulated severe accident conditions to ensure that operators are as well prepared as possible. They need to include the simulated use of actual equipment that would be deployed in the management of a severe accident.	Operators at the Fukushima Daiichi NPP had not been specifically trained on how to manually operate systems such as the Unit 1 isolation condenser and fire trucks as an alternative source for low pressure water injection. Special attention is needed in personnel training to perform actions under conditions of prolonged loss of all power, with limited information about the plant status and no information on important safety parameters. Staff training, exercises and drills need to realistically simulate the progression of severe accidents, including the simultaneous occurrence of accidents in several units at the same site. Training, exercises and drills need to involve not only on-site accident management personnel but all off-site responders at the operating organization, local, regional and national levels.	The implementation of these exercises is being done, but has to be further developed.

APPENDIX 10 DG's REPORT ON THE FUKUSHIMA DAIICHI ACCIDENT - OBSERVATIONS AND LESSONS

Sect.	Title	Section title	Key message	Background	Action Netherlands
2	Safety Assessment	Assessment of regulatory effectiveness	In order to ensure effective regulatory oversight of the safety of nuclear installations, it is essential that the regulatory body is independent and possesses legal authority, technical competence and a strong safety culture.	NISA did not have sufficient authority to take necessary actions, including inspections at regulated facilities. It is essential that the regulatory body is able to make independent decisions on safety over the lifetime of installations. To ensure such independent decision making, the regulatory body must be competent and must possess sufficient human resources, adequate legal authority – including the right to suspend operation and/or to impose improvements in safety on operating organizations – and adequate financial resources. The regulatory body needs the authority to adapt its inspection programme in the light of new safety information. It must also be able to ensure that national regulatory requirements and corresponding guidelines for assessing the safety of nuclear installations are revised periodically in accordance with scientific and technical developments, operational experience, and international standards and practices.	The ANVS has been created as an independent administrative authority and will be legally implemented in the beginning of 2017. A study was done recently to evaluate the sufficiency of competences, and will be decided upon soon. A IRRS 2014 recommendation is under implementation to strengthen the periodic revision of requirements and guidelines (at this moment however, priority has been given to the implementation of a number of European Directives (BSS, Nuclear Safety) and the updated 2014 WENRA RLs).

APPENDIX 10 DG's REPORT ON THE FUKUSHIMA DAIICHI ACCIDENT - OBSERVATIONS AND LESSONS

Sect.	Title	Section title	Key message	Background	Action Netherlands
2	Safety Assessment	Assessment of human and organizational factors	In order to promote and strengthen safety culture, individuals and organizations need to continuously challenge or re-examine the prevailing assumptions about nuclear safety and the implications of decisions and actions that could affect nuclear safety.	This can be achieved by individuals and organizations embracing a questioning attitude to identify the nature, boundaries and potential threats of their shared assumptions about nuclear safety. The institutionalization of a continuous dialogue within organizations, and among different organizations, on issues related to nuclear safety, and their significance and impact on decisions and actions, is essential. Periodic assessments of safety culture can help to foster reflection and dialogue on basic assumptions.	In 2014 during the OSART mission a ISCA safety culture assessment has been carried out and the follow up on the recommendations will be done in 2017. Obligation to ANVS comes from the 2014 EU-directive on nuclear safety. The ANVS itself has taken already a number of steps, but more will be done.
2	Safety Assessment	Assessment of human and organizational factors	A systemic approach to safety needs to consider the interactions between human, organizational and technical factors. This approach needs to be taken through the entire life cycle of nuclear installations.	The accident at the Fukushima Daiichi NPP showed that it is difficult to identify vulnerabilities in systems that involve complex interactions between people, organizations and technology because basic assumption regarding nuclear safety can remain undetected. A systemic approach that includes human, technological and organizational considerations is necessary to understand how the components of the overall system function and interact in both normal operation and accident conditions.	See former issue: ISCA applied.

APPENDIX 10 DG's REPORT ON THE FUKUSHIMA DAIICHI ACCIDENT - OBSERVATIONS AND LESSONS

Sect.	Title	Section title	Key message	Background	Action Netherlands
3	Emergency Preparedness and Response	Initial response in Japan to the accident	In preparing for the response to a possible nuclear emergency, it is necessary to consider emergencies that could involve severe damage to nuclear fuel in the reactor core or to spent fuel on the site, including those involving several units at a multi-unit plant possibly occurring at the same time as a natural disaster.	Consideration needs to be given to the possibility of a severe nuclear accident, irrespective of the cause, possibly involving more than one unit at a site and occurring simultaneously with a natural disaster, which could result in disruption at the site and of the local infrastructure. Systems, communications and monitoring equipment for providing essential information for both on-site and off-site responses need to be able to function under such circumstances. Facilities where the response will be managed (e.g. on-site and off-site emergency response centres) need to be selected or designed to be operational under a full range of emergency conditions (radiological, working and environmental conditions), and need to be suitably located and/or protected so as to ensure their operability and habitability under such conditions.	Emergencies involving core melt are prepared for. The issues mentioned are covered by the implementation of the CSA measures and the updated 2014 WENRA RL.

APPENDIX 10 DG's REPORT ON THE FUKUSHIMA DAIICHI ACCIDENT - OBSERVATIONS AND LESSONS

Sect.	Title	Section title	Key message	Background	Action Netherlands
3	Emergency Preparedness and Response	Initial response in Japan to the accident	The emergency management system for response to a nuclear emergency needs to include clearly defined roles and responsibilities for the operating organization and for local and national authorities. The system, including the interactions between the operating organization and the authorities, needs to be regularly tested in exercises.	Arrangements are needed that integrate the response to a nuclear emergency with the response to natural disasters and human-made disasters (e.g. earthquakes, floods and fires). The on-site response needs to be managed by personnel located at the site who have knowledge of the plant and of the situation. The on-site and off-site responses need to be coordinated based on pre-planned arrangements.	The roles and responsibilities are defined in the National Response plan, the regional emergency preparedness plan and the NPP response plan. There is an annual exercise programme for testing parts of the system. The whole system is tested with a frequency of about 5 years. E.g. the regional fire brigade is responsible to respond to a fire within 10 minutes. This is regularly exercised to familiarize the firefighters with the site and plant. Exercises have been done with the military to enter personell and equipment in case the site is flooded.

APPENDIX 10 DG's REPORT ON THE FUKUSHIMA DAIICHI ACCIDENT - OBSERVATIONS AND LESSONS

Sect.	Title	Section title	Key message	Background	Action Netherlands
3	Emergency Preparedness and Response	Protecting emergency workers	<p>Emergency workers need to be designated, assigned clearly specified duties, regardless of which organization they work for, be given adequate training, and be properly protected during an emergency.</p> <p>Arrangements need to be in place to integrate into the response those emergency workers who had not been designated prior to the emergency, and helpers who volunteer to assist in the emergency response.</p>	<p>The practical arrangements for the protection of emergency workers need to be addressed in a consistent manner and in adequate detail in relevant plans and procedures. Account needs to be taken of those who may not have been designated as emergency workers at the preparedness stage. Dose criteria for emergency workers need to be set in advance and applied in a consistent manner for the assigned emergency duties. Arrangements for ensuring the well-being of emergency workers (including contact with their families) need to be in place.</p> <p>In addition, arrangements need to be pre-planned for members of the public (referred to as 'helpers') who volunteer to assist in response actions to be integrated into the emergency response organization and to be afforded an adequate level of radiation protection.</p>	<p>There are legal obligations for protection, information and training of all emergency workers, no matter if they are volunteer or not. The same protection as for other radiological workers. The responsibility lies with the organization.</p>

APPENDIX 10 DG's REPORT ON THE FUKUSHIMA DAIICHI ACCIDENT - OBSERVATIONS AND LESSONS

Sect.	Title	Section title	Key message	Background	Action Netherlands
3	Emergency Preparedness and Response	Protecting the public	Arrangements need to be in place to allow decisions to be made on the implementation of predetermined urgent protective actions for the public, based on predefined plant conditions.	<p>These arrangements are necessary because decision support systems, including those using computer models, may not be able to predict the size and timing of a radioactive release (the 'source term'), the movements of plumes, deposition levels or resulting doses sufficiently quickly or accurately in an emergency to be able to provide the sole basis for deciding on initial urgent protective actions.</p> <p>At the preparedness stage, there is a need to develop an emergency classification system based on observable conditions and measurable criteria (emergency action levels). This system enables the declaration of an emergency shortly after the detection of conditions at a plant that indicate actual or projected damage to the fuel and initiation of predetermined, urgent protective actions for the public (in the predefined zones) promptly following classification of the emergency by the operator. This emergency classification system needs to cover a full range of abnormal plant conditions.</p>	<p>The so-called WENRA-HERCA approach that has been developed in the last years in Europe aims at quick decisions to protect the people in the first phase of the accident. In the later phases more time is available to precize the decision based on a systematic approach, containing the sourceterms and other information. It is been considered to adopt this approach. A classification system exists. Furthermore, triggers are mentioned in the EU-BSS which is currently implemented.</p>

APPENDIX 10 DG's REPORT ON THE FUKUSHIMA DAIICHI ACCIDENT - OBSERVATIONS AND LESSONS

Sect.	Title	Section title	Key message	Background	Action Netherlands
3	Emergency Preparedness and Response	Protecting the public	Arrangements need to be in place to enable urgent protective actions to be extended or modified in response to developing plant conditions or monitoring results. Arrangements are also needed to enable early protective actions to be initiated on the basis of monitoring results.	At the preparedness stage, there is a need to establish arrangements to, among other things: (1) define emergency planning zones and areas; (2) establish dose and operational criteria (levels of measurable quantities) for taking urgent protective actions and other response actions, including dealing with special population groups within emergency zones (e.g. patients in hospitals); (3) enable urgent protective actions to be taken before or shortly after a release of radioactive material; (4) enable prompt establishment of access controls in areas where urgent protective actions are in place; (5) extend protective actions beyond the established emergency planning zones and areas if necessary; (6) establish dose and operational criteria for taking early protective actions and other response actions (e.g. relocation and food restrictions) that are justified and optimized, taking into account a range of factors such as radiological and non-radiological consequences, including economic, social and psychological consequences; and (7) establish arrangements for revision of operational criteria for taking early protective actions on the basis of the prevailing conditions.	These 7 points are for a large part all covered by the National, Regional and Plant Response Plans and underlying/related documents. With the current implementation of the EU-BSS the remaining points will be taken in to account.

APPENDIX 10 DG's REPORT ON THE FUKUSHIMA DAIICHI ACCIDENT - OBSERVATIONS AND LESSONS

Sect.	Title	Section title	Key message	Background	Action Netherlands
3	Emergency Preparedness and Response	Protecting the public	Arrangements need to be in place to ensure that protective actions and other response actions in a nuclear emergency do more good than harm. A comprehensive approach to decision making needs to be in place to ensure that this balance is achieved.	These arrangements need to be developed with a clear understanding of the full range of possible health hazards presented in a nuclear emergency and of the potential radiological and non-radiological consequences of any protective actions. Protective actions need to be taken in a timely and safe manner, taking into account possible unfavourable conditions (e.g. severe weather or damage to infrastructure). Preparations in advance are necessary to ensure the safe evacuation of special facilities, such as hospitals and nursing homes; continuing care or supervision must be provided for those who need it.	This approach to decision making is covered by the regional and national decisionmaking structure.

APPENDIX 10 DG's REPORT ON THE FUKUSHIMA DAIICHI ACCIDENT - OBSERVATIONS AND LESSONS

Sect.	Title	Section title	Key message	Background	Action Netherlands
3	Emergency Preparedness and Response	Protecting the public	Arrangements need to be in place to assist decision makers, the public and others (e.g. medical staff) to gain an understanding of radiological health hazards in a nuclear emergency in order to make informed decisions on protective actions. Arrangements also need to be in place to address public concerns locally, nationally and internationally.	Public concerns need to be effectively addressed in a nuclear emergency. This includes the means to relate measurable quantities (e.g. dose rates) and projected radiation doses to radiological health hazards in a manner that allows decision makers (and the public) to make informed decisions concerning protective actions. Addressing public concerns contributes to mitigating both the radiological and the non-radiological consequences of the emergency. International concerns could be addressed, in part, by means of certification systems to demonstrate that tradable goods meet international standards and to reassure importing States and the public.	On national, regional and licensee level public communications are coordinated to explain the situation in clear terms. The PC people are part of the EPR structures. Risk communication and crisis communication are currently being upgraded. The approach for tradable goods will depend very much on the actual circumstances. According to The Netherlands a flexible approach is preferable.
3	Emergency Preparedness and Response	Transition from the emergency phase to the recovery phase and analysis of the response	Arrangements need to be developed at the preparedness stage for termination of protective actions and other response actions, and for transition to the recovery phase.	At the preparedness stage, there is a need to plan for the transition from the emergency phase to the long term recovery phase and for resumption of normal social and economic activities. The arrangements need to: (1) establish formal processes to decide on the termination of protective actions and other response actions; (2) clearly allocate responsibilities; (3) establish criteria for the termination of protective actions and other response actions; and (4) provide a strategy and process for consulting the public.	This will be covered with the implementation of the EU-BSS.

APPENDIX 10 DG's REPORT ON THE FUKUSHIMA DAIICHI ACCIDENT - OBSERVATIONS AND LESSONS

Sect.	Title	Section title	Key message	Background	Action Netherlands
3	Emergency Preparedness and Response	Transition from the emergency phase to the recovery phase and analysis of the response	Timely analysis of an emergency and the response to it, drawing lessons and identifying possible improvements, enhances emergency arrangements.	Such an analysis needs to include a review of all relevant arrangements, including national laws and regulations, allocation of authorities and responsibilities, emergency response plans and procedures, facilities, equipment, training and exercises. Analysis provides a basis for revision of the arrangements, as necessary. The adequacy of revised emergency arrangements needs to be demonstrated through exercises.	Improving emergency arrangements is an ongoing process, helped by frequent exercises. With the implementation of the European BSS all national laws and regulations are reviewed, and where necessary improved. About every 5 years a large system exercise is carried out.
3	Emergency Preparedness and Response	Response within the international framework for emergency preparedness and response	The implementation of international arrangements for notification and assistance needs to be strengthened.	Awareness of international arrangements for notification and assistance in a nuclear or radiological emergency, as well as existing operational mechanisms, needs to be increased, including mechanisms and procedures for notification and information exchange, for requesting and providing international assistance, etc. There is a need for enhanced training and exercises on the operational aspects of the Early Notification Convention and the Assistance Convention. Participation in existing mechanisms for the provision of international assistance under the Assistance Convention needs to be an integral part of national emergency preparedness efforts. Arrangements need to be in place at the preparedness stage for requesting and receiving assistance (on the basis of bilateral agreements or under the Assistance Convention) in a nuclear or radiological emergency.	<p>The Netherlands is member of the two Conventions. ANVS participates in the regular meetings and exercises and has designated contact points. We take part in the IAEA Convex exercises. We are not registered to RANET yet. ANVS has participated in the development of a NPP reactor data database usable for all WENRA countries during an emergency (DEEPER), now covered by EPRIMS.</p> <p>ANVS also decided to participate in the IAEA EPRIMS, but there still work has to be done to complete the reactor data database and the self-assessment against GSR Part 7. Testing the communications with the IAEA ERC during an exercise will be scheduled in the near future.</p> <p>Also the implementation of the Eu-directive (BSS) will contribute to the application of IAEA safety standards.</p>

APPENDIX 10 DG's REPORT ON THE FUKUSHIMA DAIICHI ACCIDENT - OBSERVATIONS AND LESSONS

Sect.	Title	Section title	Key message	Background	Action Netherlands
				<p>Lists of officially designated contact points, as required under the Early Notification Convention and the Assistance Convention, need to be continuously updated and prepared for immediate requests for information from the IAEA.</p> <p>Application of the IAEA safety standards on emergency preparedness and response at the national level would improve preparedness and response, facilitate communication in an emergency and contribute to the harmonization of national criteria for protective actions and other response actions.</p>	

APPENDIX 10 DG's REPORT ON THE FUKUSHIMA DAIICHI ACCIDENT - OBSERVATIONS AND LESSONS

Sect.	Title	Section title	Key message	Background	Action Netherlands
3	Emergency Preparedness and Response	Response within the international framework for emergency preparedness and response	There is a need to improve consultation and sharing of information among States on protective actions and other response actions.	Consultation and sharing of information on protective actions and other response actions among States in an emergency helps to ensure that actions are taken consistently. In addition, a clear and understandable explanation of the technical basis for decisions on protective actions and other response action is crucial in order to increase public understanding and acceptance at both the national and international levels.	Consultation and information sharing with the effected countries is part of the HERCA-WENRA approach, in order to harmonize the measures for protecting the public. The Netherlands already has bilateral arrangements for information sharing during nuclear emergencies with the neighbouring countries. Currently increased efforts have started and are going on to improve exchange of information with the neighbouring states, even in case public unrest arises without being an emergency situation.

APPENDIX 10 DG's REPORT ON THE FUKUSHIMA DAIICHI ACCIDENT - OBSERVATIONS AND LESSONS

Sect.	Title	Section title	Key message	Background	Action Netherlands
4	Radiological Consequences	Radioactivity in the environment	In case of an accidental release of radioactive substances to the environment, the prompt quantification and characterization of the amount and composition of the release is needed. For significant releases, a comprehensive and coordinated programme of long term environmental monitoring is necessary to determine the nature and extent of the radiological impact on the environment at the local, regional and global levels.	The quantification and characterization of the source term of the accident at the Fukushima Daiichi NPP proved to be difficult. Prompt monitoring of the environment provides confirmation of the levels of radionuclides and establishes the initial basis for protecting people. The results can be used to inform the public and to develop strategies for response and recovery activities. It is also important to continue environmental monitoring to verify that there are no further significant releases of radionuclides and to provide information to decision makers and other stakeholders on the possible redistribution of radionuclides in the environment over time.	In the Netherlands we have a National Radiation Monitoring Network (NMR), with over 150 monitors positioned all around the country. During an emergency, this Monitoring Network is extended by monitoring teams from the fire brigade and dedicated mobile measurement vehicles from the Institute for Public Health and the Environment (RIVM) and Defense, to monitor and measure several types of radiation and nuclides.

APPENDIX 10 DG's REPORT ON THE FUKUSHIMA DAIICHI ACCIDENT - OBSERVATIONS AND LESSONS

Sect.	Title	Section title	Key message	Background	Action Netherlands
4	Radiological Consequences	Protecting people against radiation exposure	<p>Relevant international bodies need to develop explanations of the principles and criteria for radiation protection that are understandable for non-specialists in order to make their application clearer for decision makers and the public. As some protracted protection measures were disruptive for the affected people, a better communication strategy is needed to convey the justification for such measures and actions to all stakeholders, including the public.</p>	<p>There is a recognized need for simple explanations of a number of radiation protection issues, including:</p> <ul style="list-style-type: none"> • Differences between the concepts of dose limits and reference levels and the associated rationale; • Criteria for the justification of protective measures and actions aimed at averting radiation doses in the long term, in particular when they involve significant disruptions to normal life; • Specific situations relating to the radiation protection of workers in an emergency. <p>The principles of radiation protection are based not solely on science, but also on value judgements based on ethical principles. In some circumstances, protective measures and actions involve protracted social disruption. Under these circumstances, the potential benefit from avoiding radiation doses must outweigh the individual and social detriment caused by the protective measures and actions themselves. It is important to explain to stakeholders the justification for long-standing radiation protection measures and actions.</p>	<p>Risk communication and crisis communication are currently being upgraded in general. We are member of the Conventions and the mentioned issue has been discussed at the meeting of competent authorities, which decided to ask the EPRESC to propose the way forward. ANVS is also participating in this group.</p>

APPENDIX 10 DG's REPORT ON THE FUKUSHIMA DAIICHI ACCIDENT - OBSERVATIONS AND LESSONS

Sect.	Title	Section title	Key message	Background	Action Netherlands
4	Radiological Consequences	Protecting people against radiation exposure	Conservative decisions related to specific activity and activity concentrations in consumer products and deposition activity led to extended restrictions and associated difficulties. In a prolonged exposure situation, consistency among international standards, and between international and national standards, is beneficial, particularly those associated with drinking water, food, non-edible consumer products and deposition activity on land.	The Japanese authorities established measures for controlling the presence of radioactive substances in consumer products, which were generally more stringent than the available international guidance. The current international system for controlling radioactivity in consumer products is governed by distinct guidance, for example the Codex Alimentarius for food (including bottled water) in international trade, IAEA safety standards for food and drinking water for use in an emergency, WHO guidelines for drinking water in existing exposure situations and IAEA safety standards for non-edible products for exemption purposes. There is a need for consistency in the international standards for acceptable levels of radioactivity in products for public consumption in order to facilitate their application by regulatory bodies and their understanding by the public. National standards need to be in line with international standards, where this is feasible. Moreover, there is a need for criteria for dealing with the protracted presence of radionuclides on land.	The maximum permitted levels of radioactive contamination of foodstuffs and of feeding stuffs following a nuclear accident or any other case of radiological emergency are the same in Europe and laid down in the Council Regulation (EURATOM) No 2218/89.

APPENDIX 10 DG's REPORT ON THE FUKUSHIMA DAIICHI ACCIDENT - OBSERVATIONS AND LESSONS

Sect.	Title	Section title	Key message	Background	Action Netherlands
4	Radiological Consequences	Radiation exposure	<p>Personal radiation monitoring of representative groups of members of the public provides invaluable information for reliable estimates of radiation doses and needs to be used together with environmental measurements and appropriate dose estimation models for assessing public dose.</p>	<p>The early estimation of doses was based on environmental measures and modelling, resulting in some conservative assumptions on doses incurred and projected. Personal monitoring of 131I in the thyroids of children needs to be undertaken as soon as possible following radioiodine releases to the environment, owing to the short half-life of this radionuclide. Personal monitoring of external radiation and the internal presence of the longer lived radionuclides (e.g. 137Cs) needs to be undertaken as soon as feasible and to continue over time, as appropriate.</p> <p>In the absence of personal radiation measurements, modelling of environmental and ambient data may be needed to estimate the radiation doses incurred by individuals. In these cases, the uncertainties associated with the assumptions used in the models need to be clearly explained, particularly if the results are being used to inform decision making on protective measures and actions or to estimate the potential for radiation induced health effects.</p>	<p>We use modelling of environmental and ambient data to estimate the radiation doses . Monitoring on individuals is arranged ad hoc and further on in the hospitals.</p>

APPENDIX 10 DG's REPORT ON THE FUKUSHIMA DAIICHI ACCIDENT - OBSERVATIONS AND LESSONS

Sect.	Title	Section title	Key message	Background	Action Netherlands
4	Radiological Consequences	Radiation exposure	While dairy products were not the main pathway for the ingestion of radioiodine in Japan, it is clear that the most important method of limiting thyroid doses, especially to children, is to restrict the consumption of fresh milk from grazing cows.	The estimates of thyroid doses to children following the accident were low. This was the result of a combination of factors, including the time of year (before the growing season), agricultural practices in Japan, low consumption of cow's milk by infants and the controls on milk consumption that were immediately introduced. These factors contributed to the low level of intake of ¹³¹ I.	This is one of the standard actions in the NL action portfolio.

APPENDIX 10 DG's REPORT ON THE FUKUSHIMA DAIICHI ACCIDENT - OBSERVATIONS AND LESSONS

Sect.	Title	Section title	Key message	Background	Action Netherlands
4	Radiological Consequences	Radiation exposure	A robust system is necessary for monitoring and recording occupational radiation doses, via all relevant pathways, particularly those due to internal exposure that may be incurred by workers during severe accident management activities. It is essential that suitable and sufficient personal protective equipment be available for limiting the exposure of workers during emergency response activities and that workers be sufficiently trained in its use.	Early and continued direct measurements of the radiation exposure and the levels of radionuclides incorporated by emergency workers are the most valuable approach to obtaining information for estimating radiation risks and potential health effects and to optimizing protection. There is a need to monitor and register occupational radiation doses through a robust system of personal dosimeters and measurements. Monitoring of 131I in the thyroid needs to be undertaken as soon as possible. Immediately following the Fukushima Daiichi accident, the provision of personal protective equipment for restricting the exposure of workers and monitoring was difficult.	There are legal provisions to monitor and register doses of emergency workers and to protect, inform and train these workers. The organisation that employs those workers is responsible for the implementation.

APPENDIX 10 DG's REPORT ON THE FUKUSHIMA DAIICHI ACCIDENT - OBSERVATIONS AND LESSONS

Sect.	Title	Section title	Key message	Background	Action Netherlands
4	Radiological Consequences	Health effects	The risks of radiation exposure and the attribution of health effects to radiation need to be clearly presented to stakeholders, making it unambiguous that any increases in the occurrence of health effects in populations are not attributable to exposure to radiation if levels of exposure are similar to the global average background levels of radiation.	In the case of the Fukushima Daiichi accident, doses to members of the public were low and comparable with typical global average background doses. There is a need to clearly inform the public, particularly the people affected, that no discernible increased incidence of radiation related health effects is expected among exposed members of the public and their descendants as a result of the accident. An understanding of radiation and its possible health effects is important for all those involved in an emergency, in particular for physicians, nurses, radiation technologists and medical first responders. This needs to be ensured through appropriate education and training of medical professionals in the topics of radioactivity, radiation and health effects associated with radiation exposure.	Riskcommunication and crisiscommunication are currently being upgraded.

APPENDIX 10 DG's REPORT ON THE FUKUSHIMA DAIICHI ACCIDENT - OBSERVATIONS AND LESSONS

Sect.	Title	Section title	Key message	Background	Action Netherlands
4	Radiological Consequences	Health effects	After a nuclear accident, health surveys are very important and useful, but should not be interpreted as epidemiological studies. The results of such health surveys are intended to provide information to support medical assistance to the affected population.	The Fukushima Health Management Survey provides valuable health information for the local community, helping to ensure that any health effects are detected quickly, and that appropriate actions are taken to protect the health of the population. The overall results of health checks may provide important information, but they should not be misinterpreted as the results of an epidemiological assessment.	The Netherlands agrees with this. Health surveys are normal practice.
4	Radiological Consequences	Health effects	There is a need for radiological protection guidance to address the psychological consequences to members of the affected populations in the aftermath of radiological accidents. A Task Group of the ICRP has recommended that "strategies for mitigating the serious psychological consequences arising from radiological accidents be sought".	Psychological conditions have been reported as a consequence of the accident. This has been a repeated issue in the aftermath of accidents involving radiation exposure. In spite of their importance, these consequences have not been recognized in international recommendations and standards on radiological protection.	In case of an incident with a NPP it is foreseen that there will be dealt with the psychological consequences in the same way as in the aftermath of an a large chemical or other incident. This will be organized in cooperation with the Arq foundation, a psychotrauma expert group.

APPENDIX 10 DG's REPORT ON THE FUKUSHIMA DAIICHI ACCIDENT - OBSERVATIONS AND LESSONS

Sect.	Title	Section title	Key message	Background	Action Netherlands
4	Radiological Consequences	Health effects	Factual information on radiation effects needs to be communicated in an understandable and timely manner to individuals in affected areas in order to enhance their understanding of protection strategies, to alleviate their concerns and support their own protection initiatives.	Arrangements at the national and local level need to be put in place to share information in an understandable manner with the public who may be affected by accidents with radiological consequences. The arrangements need to allow for person to person dialogue so that individuals can seek clarifications and express their concerns. These arrangements will require the concerted efforts of the relevant authorities, experts and professionals in supporting and advising the affected individuals and communities. Sharing information is important when conveying decisions to protect these individuals, including the support of their own initiatives.	Riskcommunication and crisiscommunication are currently being upgraded.

APPENDIX 10 DG's REPORT ON THE FUKUSHIMA DAIICHI ACCIDENT - OBSERVATIONS AND LESSONS

Sect.	Title	Section title	Key message	Background	Action Netherlands
4	Radiological Consequences	Radiological consequences for non-human biota	<p>During any emergency phase, the focus has to be on protecting people. Doses to the biota cannot be controlled and could be potentially significant on an individual basis. Knowledge of the impacts of radiation exposure on non-human biota needs to be strengthened by improving the assessment methodology and understanding of radiation induced effects on biota populations and ecosystems. Following a large release of radionuclides to the environment, an integrated perspective needs to be adopted to ensure sustainability of agriculture, forestry, fishery and tourism, and of the use of natural resources.</p>	<p>It may be difficult to substantially reduce doses to non-human biota because of the impracticability of introducing countermeasures. Impact assessments for plants and animals in the aftermath of accidents such as that at the Fukushima Daiichi NPP require consideration of numerous potential stressors — radiation exposure being one of many. Consideration also needs to be given to the potential for the buildup and accumulation of long lived radionuclides in the environment and how this might affect plants and animals over multiple generations.</p>	<p>In line with the European BSS the starting point is protection of the public. This should ensure a sufficient protection of the environment, since all exposure pathways are considered.</p>

APPENDIX 10 DG's REPORT ON THE FUKUSHIMA DAIICHI ACCIDENT - OBSERVATIONS AND LESSONS

Sect.	Title	Section title	Key message	Background	Action Netherlands
5	Post-accident Recovery	Off-site remediation of areas affected by the accident	Pre-accident planning for post-accident recovery is necessary to improve decision making under pressure in the immediate post-accident situation. National strategies and measures for post-accident recovery need to be prepared in advance in order to enable an effective and appropriate overall recovery programme to be put in place in case of a nuclear accident. These strategies and measures need to include the establishment of a legal and regulatory framework; generic remediation strategies and criteria for residual radiation doses and contamination levels; a plan for stabilization and decommissioning of damaged nuclear facilities; and a generic strategy for managing large	<p>These strategies and measures need to include:</p> <ul style="list-style-type: none"> • The establishment of a legal and regulatory framework that specifies the roles and responsibilities of the various institutions to be involved. This framework needs to address off-site remediation, on-site stabilization and preparations for decommissioning, management of contaminated material and radioactive waste, and community revitalization and stakeholder engagement. • Generic remediation strategies and criteria (reference and derived action levels) for residual radiation doses and contamination levels. • A plan for the stabilization of conditions on the site of a damaged nuclear facility and preparations for its decommissioning. • Development of a generic strategy for managing large quantities of contaminated material and radioactive waste, supported by generic safety assessments for storage and disposal facilities. • Sufficient flexibility to ensure that the management of post-accident conditions can be adapted in response to changing conditions and acquired information and experience. 	<p>Currently there is no national strategy as advised in this issue.</p> <p>Action: draw a national remediation and post-accident recovery strategy taking into account Fukushima LL.</p> <p>The EU-BSS will require the licensees to prepare for their part of recovery.</p>
			quantities of contaminated material and radioactive waste.		235/243

APPENDIX 10 DG's REPORT ON THE FUKUSHIMA DAIICHI ACCIDENT - OBSERVATIONS AND LESSONS

Sect.	Title	Section title	Key message	Background	Action Netherlands
5	Post-accident Recovery	Off-site remediation of areas affected by the accident	Remediation strategies need to take account of the effectiveness and feasibility of individual measures and the amount of contaminated material that will be generated in the remediation process.	<p>Having established reference levels for residual radiation doses and contamination levels, it is essential to control carefully the amount of contaminated material generated by implementing the remediation strategy in order to minimize the amount of waste to be managed. The absence of preparations for recovery from a nuclear accident in Japan meant that, initially, large volumes of potentially contaminated material were generated. As time elapsed and planning developed, remediation actions were optimized, leading to improved control of the amount of waste to be managed.</p> <p>Pilot projects were useful in determining both the effectiveness of particular remediation techniques and the amount of waste generated by particular techniques. Pilot projects also contributed to establishing procedures for the radiation protection of workers.</p>	Input for the National Strategy

APPENDIX 10 DG's REPORT ON THE FUKUSHIMA DAIICHI ACCIDENT - OBSERVATIONS AND LESSONS

Sect.	Title	Section title	Key message	Background	Action Netherlands
5	Post-accident Recovery	Off-site remediation of areas affected by the accident	As part of the remediation strategy, the implementation of rigorous testing of and controls on food is necessary to prevent or minimize ingestion doses.	The systematic implementation of rigorous testing of and controls on food after the accident demonstrated that ingestion doses can be kept at low levels. To establish confidence in locally produced food, local monitoring stations were set up to allow people in affected areas to bring food to be measured. This control of ingestion doses simplified the recovery by allowing remediation to focus on techniques that reduce external doses.	Input for the National Strategy
5	Post-accident Recovery	Off-site remediation of areas affected by the accident	Further international guidance is needed on the practical application of safety standards for radiation protection in post-accident recovery situations.	Further practical guidance is needed on the application of the IAEA safety standards in existing exposure situations. The reference levels adopted for the early post-accident years need to be periodically reviewed and modified, as appropriate, in response to the changing radiological conditions. The guidance needs to include a methodology for the selection of case and site specific reference levels, in terms of dose and derived quantities, as well as mechanisms to integrate technical and scientific advice with other socially relevant factors to establish a coherent, transparent and collectively accepted decision making process.	The Netherlands agrees with that and awaits the results of international effort to provide this guidance.

APPENDIX 10 DG's REPORT ON THE FUKUSHIMA DAIICHI ACCIDENT - OBSERVATIONS AND LESSONS

Sect.	Title	Section title	Key message	Background	Action Netherlands
5	Post-accident Recovery	On-site stabilization and preparations for decommissioning	Following an accident, a strategic plan for maintaining long term stable conditions and for the decommissioning of accident damaged facilities is essential for on-site recovery. The plan needs to be flexible and readily adaptable to changing conditions and new information.	Preparations for the decommissioning of a facility damaged in an accident would first involve stabilization to ensure that structures, systems and components are in place to reliably maintain stable conditions for the long term until their functions are no longer needed. Post-accident preparations for decommissioning take decades. Arrangements are necessary to maintain the necessary expertise and workforce throughout this entire period. Decision making on interim decommissioning stages and on the final conditions of the site and the damaged reactors needs to include a dialogue with stakeholders. Decision making on decommissioning depends on the conditions of the damaged reactors, fuel and debris, which cannot be determined in the period immediately following an accident. Factors to be considered in decision making include: dose levels for workers in decommissioning; the volumes and types of waste generated; and the efforts necessary for waste treatment. In the early stage of cleanup activities, it is unrealistic to predict the final conditions of the plant site, but expectations and plans for the land need to be considered in the decision making process.	Decommissioning should be a subchapter of the National Strategy for the recovery phase that has to be developed

APPENDIX 10 DG's REPORT ON THE FUKUSHIMA DAIICHI ACCIDENT - OBSERVATIONS AND LESSONS

Sect.	Title	Section title	Key message	Background	Action Netherlands
5	Post-accident Recovery	On-site stabilization and preparations for decommissioning	Retrieving damaged fuel and characterizing and removing fuel debris require solutions that are specific to the accident, and special methods and tools may need to be developed.	A reactor accident involving damage to nuclear fuel results in particular conditions in the reactor that are unique to the accident. The removal and management of damaged fuel elements and of debris from melted fuel are complex tasks. The debris needs to be characterized, removed, packaged and placed in storage until disposal is implemented, under difficult conditions, associated largely with high radiation levels.	To be included in the strategic plan.

APPENDIX 10 DG's REPORT ON THE FUKUSHIMA DAIICHI ACCIDENT - OBSERVATIONS AND LESSONS

Sect.	Title	Section title	Key message	Background	Action Netherlands
5	Post-accident Recovery	Management of contaminated material and radioactive waste	National strategies and measures for post-accident recovery need to include the development of a generic strategy for managing contaminated liquid and solid material and radioactive waste, supported by generic safety assessments for discharge, storage and disposal.	<p>A waste management strategy is needed for the implementation of pre-disposal management (e.g. handling, treatment, conditioning and storage) of accident-generated contaminated material and radioactive waste. It also needs to identify appropriate routes for the disposal of materials. Waste management strategies may involve the use of existing processing, storage and disposal facilities, such as incinerators or leachate controlled landfills. However, other approaches may be necessary, depending on the volumes and characteristics of the waste involved. The development of such strategies could be supported by the development of a generic safety case.</p> <p>Strategies for the post-accident management of large volumes of contaminated water are also necessary, including consideration of its controlled discharge to the environment. Although there is international guidance for discharges during the normal operation of nuclear facilities, further guidance on its application in post-accident situations is needed.</p>	Input for the National Strategy

APPENDIX 10 DG's REPORT ON THE FUKUSHIMA DAIICHI ACCIDENT - OBSERVATIONS AND LESSONS

Sect.	Title	Section title	Key message	Background	Action Netherlands
5	Post-accident Recovery	Community revitalization and stakeholder engagement	It is necessary to recognize the socioeconomic consequences of any nuclear accident and of the subsequent protective actions, and to develop revitalization and reconstruction projects that address issues such as reconstruction of infrastructure, community revitalization and compensation.	Nuclear accidents and the protective and remedial actions introduced in both the emergency phase and the post-accident recovery phase, with the objective of reducing doses, have far-reaching consequences on the way of life of the affected population. Engagement of stakeholders at various stages of remediation and recovery is essential.	Input for the National Strategy

APPENDIX 10 DG's REPORT ON THE FUKUSHIMA DAIICHI ACCIDENT - OBSERVATIONS AND LESSONS

Sect.	Title	Section title	Key message	Background	Action Netherlands
5	Post-accident Recovery	Community revitalization and stakeholder engagement	Support by stakeholders is essential for all aspects of post-accident recovery. In particular, engagement of the affected population in the decision making processes is necessary for the success, acceptability and effectiveness of the recovery and for the revitalization of communities. An effective recovery programme requires the trust and the involvement of the affected population. Confidence in the implementation of recovery measures has to be built through processes of dialogue, the provision of consistent, clear and timely information, and support to the affected population.	Governments need to provide a realistic description of a recovery programme to the public that is consistent, clear and timely. A variety of information channels, including social media, need to be used to reach all interested groups. Perceptions of radiation risks and answers to questions about 'safe' radiation levels have many dimensions, including scientific, societal and ethical. These answers need to be clearly communicated to relevant communities through educational programmes — ideally before an accident has occurred. It is important that the affected population receive support for local recovery efforts. Support for self-help actions related to remediation and for rebuilding businesses can increase involvement in the recovery programme, and build the trust of the affected population.	Input for the National Strategy

This is a publication of

**Ministry of Infrastructure and the
Environment**

Prepared by
The Authority for Nuclear Safety and
Radiation Protection (ANVS)

Bezuidenhoutseweg 67 | 2594 AC The Hague, Netherlands
P.O. Box 16001 | 2500 BA The Hague, Netherlands
www.anvs.nl

August 2016 | 94889