

Testrapport nr.:
2231943.0504-EMC

Meetrapport

Elektromagnetische velden rond het spoor

Identificatie van de omgeving	Spoorwegovergang
Meetlocatie	Braakstraat in de buurt van de spoorovergang bij station Oss-West 5344 AH, Oss Nederland
Naam en adres opdrachtgever	Agentschap Telecom Piet Mondriaanlaan 54, 3812 GV Amersfoort Postbus 1671, 3800 BR Amersfoort www.agentschaptelecom.nl
Datum van afgifte	14-1-2019

INDEX

	Pagina
Doel en strekking van de metingen	5
Beperkingen.....	5
Samenvatting en opmerkingen.....	6
1 Meetmethode/normen	8
2 Bedieningsomstandigheden tijdens het meten	9
3 Meetplan.....	9
4 Meetresultaten.....	12
4.1 Emissie uitgestraald statisch magnetisch veld.....	12
4.1.1 Testopstellingen en meetprocedure:.....	12
4.1.2 Overzicht.....	15
4.2 Emissie uitgestraald EM-veld, 5 Hz - 30 MHz.....	17
4.2.1 Testopstelling en meetprocedure.....	17
4.2.2 Overzicht.....	20
4.3 Emissie uitgestraald elektrisch veld, 30 MHz - 1000 MHz.....	21
4.3.1 Testopstelling en meetprocedure:.....	21
4.3.2 Overzicht.....	24
4.4 Emissie uitgestraald elektrisch veld, 1 - 6 GHz.....	25
4.4.1 Testopstelling en meetprocedure:.....	25
4.4.2 Overzicht.....	27
Annex 1: Radiated static magnetic field measurement results.....	28
A1.1 Stoptrain (acceleration), h=0 m., d=0 m.	28
A1.2 Intercity-IC (transit), h=0 m., d=0 m.	35
A1.3 Stoptrain (acceleration), h=0 m., d=0.5 m.	37
A1.4 Intercity-IC (transit), h=0 m., d=0.5 m.	38
A1.5 Stoptrain (acceleration), h=0 m., d=1 m.	40
A1.6 Intercity-IC (transit), h=0 m., d=1 m.	43
A1.7 Stoptrain (acceleration), h=0.3 m., d=1.25 m.	45
A1.8 Intercity-IC (transit), h=0.3 m., d=1.25 m.	50
A1.9 Braking (@SP2ADC), h=0.3 m., d=1.25 m.	54
A1.10 Stoptrain (acceleration), h=0.7 m., d=1.25 m.	55

A1.11 Intercity-IC (transit), h=0.7 m., d=1.25 m.	60
A1.12 Braking (@SP2ADC), h=0.7 m., d=1.25 m.	63
A1.13 Stoptrain (acceleration), h=1 m., d=1.25 m.	64
A1.14 Intercity-IC (transit), h=1 m., d=1.25 m.	69
A1.15 Stoptrain (acceleration), h=0.3 m., d=3 m.	73
A1.16 Intercity-IC (transit), h=0.3 m., d=3 m.	76
A1.17 Stoptrain (acceleration), h=1 m., d=3 m.	79
A1.18 Intercity-IC (transit), h=1 m., d=3 m.	82
A1.19 Stoptrain (acceleration), h=0.3 m., d=6 m.	85
A1.20 Intercity-IC (transit), h=0.3 m., d=6 m.	88
A1.21 Stoptrain (acceleration), h=1 m., d=6 m.	90
A1.22 Intercity-IC (transit), h=1 m., d=6 m.	94
A1.23 Braking (@SP2ADC), h=1 m., d=6 m.	97
A1.24 Stoptrain (acceleration), h=1 m., d=10 m.	98
A1.25 Intercity-IC (transit), h=1 m., d=10 m.	100
A1.26 Stoptrain (acceleration), h=1 m., d=30 m.	102
A1.27 Intercity-IC (transit), h=1 m., d=30 m.	105
Annex 2: Radiated EM field emission measurement results (5 Hz – 30 MHz).....	107
A2.1 Stoptrain (acceleration)/ Transit / Braking, h=0 m., d=0 m.	107
A2.2 Stoptrain (acceleration)/ Transit / Braking, h=0.3 m., d=1.25 m. (5 Hz – 400 KHz)	118
A2.3 Stoptrain (acceleration)/ Transit / Braking, h=1 m., d=1.25 m. (5 Hz – 400 KHz)	120
A2.4 Stoptrain (acceleration)/ Transit / Braking, h=0.3 m., d=3 m. (5 Hz – 400 KHz)	122
A2.5 Stoptrain (acceleration)/ Transit / Braking, h=1 m., d=3 m. (5 Hz – 400 KHz)	124
A2.6 Stoptrain (acceleration)/ Transit / Braking, h=1.5 m., d=6 m. (5 Hz – 400 KHz)	126
A2.7 Stoptrain (acceleration)/ Transit / Braking, h=1 m., d=10 m. (5 Hz – 400 KHz)	127
A2.8 Stoptrain (acceleration)/ Transit / Braking, h=1 m., d=30 m. (5 Hz – 400 KHz)	129
A2.9 Barrier system, h=1.55 m., d=0 m. and d=1 m. (5 Hz – 400 KHz)	130
A2.10 Stoptrain (acceleration)/ Transit / Braking, h=0.5 m., d=1.25 m. (9 KHz - 30 MHz)	132
A2.11 Stoptrain (acceleration)/ Transit / Braking, h=1 m., d=1.25 m. (9 KHz - 30 MHz)	139
A2.12 Stoptrain (acceleration)/ Transit / Braking, Barrier, h=1 m., d=3 m. (9 KHz - 30 MHz)	146
A2.13 Stoptrain (acceleration)/ Transit / Braking, Barrier, h=1 m., d=10 m. (9 KHz - 30 MHz)	154
A2.14 Stoptrain (acceleration)/ Transit / Braking, Barrier, h=1 m., d=30 m. (9 KHz - 30 MHz)	160
Annex 3: Radiated Electric field emission measurement results (30 – 1000 MHz).....	167

A3.1 Stoptrain (acceleration)/ Transit / Braking, h=2 m., d=3 m. (30 – 1000 MHz)	167
A3.2 Stoptrain (acceleration)/ Transit / Braking, Barrier, h=2.5 m., d=10 m. (30 – 1000 MHz)	171
A3.3 Stoptrain (acceleration)/ Transit / Braking, Barrier, h=3 m., d=30 m. (30 – 1000 MHz)	174
A3.4 Stoptrain (acceleration)/ Transit / Braking, Barrier and surrounding, h=3 m., d=30 m. (30 – 1000 MHz).....	176
Annex 4: Radiated Electric field emission measurement results (1 – 6 GHz).....	181
A4.1 Stoptrain (acceleration)/ Transit / Braking, h=2 m., d=3 m. (1 - 6 GHz)	181
A4.2 Stoptrain (acceleration)/ Transit / Braking, h=2.5 m., d=10 m. (1 - 6 GHz)	187
A4.3 Stoptrain (acceleration)/ Transit / Braking, h=2.5 m., d=30 m. (1 - 6 GHz)	190
A4.4 Stoptrain (acceleration)/ Transit / Braking, Barrier and surrounding, h=2.5 m., d=30 m. (1 - 6 GHz).....	193
Annex 5: Test Photos	197
Annex 6 - Measurement Uncertainties	205
Annex 7 – Train Data.....	206

DOEL EN STREKKING VAN DE METINGEN

Het doel van de metingen is het in kaart brengen van de spoorwegovergangen en de omgeving van de overgangen met betrekking tot elektromagnetische velden (EM-velden).

De strekking van de metingen omvat de uitgestraalde elektromagnetische velden die worden gegenereerd door de infrastructuur van de spoorwegen binnen het frequentiebereik van DC (0 Hz) tot 6 GHz bij bedrijfsmodi die later in dit document worden beschreven.

De magnetische component van het elektromagnetische veld is gemeten van DC tot en met 30 MHz en de elektrische component is gemeten van 5 Hz tot en met 6 GHz.



(De bron van de foto is Google Maps)

BEPERKINGEN

- Er is slechts aan één kant van de spoorwegovergang gemeten.
- De metingen zijn alleen uitgevoerd in de richting van het 'voertuig' en tot een maximale afstand van 30 meter vanaf de spoorwegovergang (zie figuur 3-1 en 3-2 voor meer informatie).

SAMENVATTING EN OPMERKINGEN

De metingen voor het in kaart brengen van de spoorwegovergangen en de omgeving daarvan met betrekking tot de elektromagnetische velden die in dit rapport worden gepresenteerd, zijn uitgevoerd op 19, 20, 21, 23 en 26 november 2018 op de locatie die op de eerste pagina wordt vermeld. De sterkten van de EM-velden in het frequentiebereik DC - 6 GHz zijn gemeten aan de hand van specifieke testmethoden die in het rapport worden genoemd. In totaal zijn er 490 metingen uitgevoerd om de EM-velden bij de bedrijfsmodi van de treinen en het spoorwegsysteem te meten. De meest ongunstige resultaten van de 490 metingen worden vermeld. Voor elke meting wordt het tijdstip, de datum, het type trein, het serienummer en de stroomsterkte op de rails vermeld. De meetgegevens die in het rapport worden gegeven, zijn een combinatie van EM-velden gegenereerd door het spoor en de omgeving (gebouwen, straatverlichting, voertuigen, mobiele telefoons, elektrische fietsen, enzovoort).

Het testplan van DEKRA met referentienummer 2231943.0503-EMC is gecontroleerd en goedgekeurd door Agentschap Telecom voordat DEKRA aan de metingen is begonnen.

- Het maximale statische magnetische veld dat is gemeten, was 2,574 mT. Deze waarde is gemeten op de rails (h=0 m, a=0 m).
- Hoe verder van het testspoor verwijderd, hoe zwakker het statische magnetische veld werd (zie figuur 4.1-3).
- Een aanzienlijk sterk statisch magnetisch veld werd gemeten zelfs nadat de trein het station had verlaten en een aantal kilometer had gereden. Dit betekent dat er, zelfs als er geen trein is, een statisch magnetisch veld bij het spoor en de omgeving van het spoor is.
- Het is vooral het spoor dat bijdraagt aan het totale gemeten statische magnetische veld. De trein zelf draagt ook bij aan het gemeten veld door statische magnetische velden te creëren. Hoe groot deze bijdrage is, is afhankelijk van het type trein, de versnelling/snelheid en de beladingstoestand van de trein.
- Er is geen significant verschil in de sterkte van het EM-veld als de sensor of antenne op een andere hoogte wordt geplaatst (hoogte boven de grond).
- De sterkte van het EM-veld dat werd gemeten tijdens het remmen/vertragen van de trein is niet significant (verwaarloosbaar) vergeleken met de omstandigheden tijdens versnelling en doorreis.
- Over het algemeen genereren de versnellende treinen (stoptreinen) een hoger statisch magnetisch veld dan doorreizende treinen (intercity's).
- De spoorbomen veroorzaken geen significante EM-veldsterkten.
- De spoorbomen voldoen aan de serie EN 50121-normen (9 KHz - 1000 MHz).
- Het maximale elektrische veld dat werd gemeten binnen het frequentiebereik van 5 Hz - 400 KHz was 97,7 V/m (gemeten op 1,25 m afstand van het spoor). De hoogste gemeten sterkten werden veroorzaakt door doorreizende treinen.
- Het maximale magnetische veld gemeten binnen het frequentiebereik van 5 Hz - 400 KHz was 23,35 μ T (gemeten tussen de sporen). De sterkte van het magnetische veld op 3 meter afstand is minder dan 5 μ T.
- Op 10 m afstand van het spoor is een elektrisch veld van meer dan 10 V/m gemeten (het frequentiebereik van 5 Hz - 400 KHz).
- De sterkte van het magnetische veld op 10 m afstand is relatief klein vergeleken met de meetresultaten op 1 m en 3 m afstand (het frequentiebereik van 5 Hz - 400 KHz).

- Er is geen significant elektrisch veld gemeten veroorzaakt door het spoor, de spoorbomen en de omgeving binnen het frequentiebereik van 1 - 6 GHz, met uitzondering van de elektrische velden die worden gegenereerd door radio apparatuur.
- De metingen die werden uitgevoerd binnen het frequentiebereik van 9 KHz - 1000 MHz op 10 m afstand van het spoor omvatten ook de limietwaarden zoals gedefinieerd in de serie EN 50121-normen. Het spoorwegsysteem voldoet aan de betreffende limieten die worden gedefinieerd in de serie EN 50121-normen. Er zijn geen limieten gedefinieerd voor meetafstanden anders dan 10 m. De sterkte van alle gemeten elektrische velden ligt onder de limietwaarde, met uitzondering van omgevings-/achtergrondverstoringen bij de aangewezen RF-banden (mobiele telefoons, zendstations, enzovoort). Een aantal van de gemeten elektrische velden die in de grafieken in de bijlagen van dit rapport (RF-verstoringen) worden gegeven, zijn afkomstig van mensen die met de trein reizen en hun mobiele telefoon of andere draadloze apparatuur gebruiken. De limieten die in de serie EN 50121-normen worden gegeven, gelden niet voor de beoogde RF-frequenties als mobiele telefoons, Wi-Fi, enzovoort. Er zijn geen wettelijke vereisten voor het spoorwegsysteem onder 9 KHz en boven 1000 MHz.

1 MEETMETHODE/NORMEN

In de serie EN 50121-normen (zie hieronder) wordt de elektromagnetische omgeving van het volledige spoor gedefinieerd en worden testmethoden en emissielimieten binnen het frequentiebereik van 9 KHz tot en met 1 GHz van het volledige spoorwegsysteem naar de buitenwereld gespecificeerd.

Er is geen specifieke standaardmethode voor het meten van de elektromagnetische velden die door de volledige spoorinfrastructuur/het volledige spoorwegsysteem worden gegenereerd en die het volledige bereik van DC tot 9 KHz en van 1 GHz tot 6 GHz beslaat.

Andere momenteel beschikbare normen die hieronder worden vermeld, gelden voor producten of systemen die zijn bedoeld om te worden gebruikt/geïnstalleerd in de omgeving van het spoor. De methoden die in deze normen worden voorgeschreven, kunnen niet volledig worden gebruikt voor het meten van de elektromagnetische velden die worden gegenereerd door de spoorinfrastructuur/het spoorwegsysteem. Daarom heeft DEKRA alternatieve methoden voorgesteld (in het geleverde testplan 2231943.0503-EMC) voor de frequentiebereiken die momenteel niet aan bod komen in de Europese normen (CENELEC en IEC).

De meetmethoden die in dit testrapport worden gespecificeerd/beschreven, zijn de methoden die, waar mogelijk, zijn gebaseerd op normen voor specifieke producten/productfamilies en de expertise van de DEKRA-deskundigen.

De meetmethoden die in dit testrapport worden genoemd, zijn gebaseerd op de volgende normen:

Norm	Jaar	Beschrijving
EN 50121-1	2017	Spoorwegen en soortgelijk geleid vervoer - Elektromagnetische compatibiliteit - Deel 1: Algemeen
EN 50121-2	2006	Spoorwegen en soortgelijk geleid vervoer - Elektromagnetische compatibiliteit - Deel 2: Emissie van het gehele vervoersysteem naar de buitenwereld
EN 50121-2	2017	Spoorwegen en soortgelijk geleid vervoer - Elektromagnetische compatibiliteit - Deel 2: Emissie van het gehele vervoersysteem naar de buitenwereld
EN 50121-3-1	2017	Spoorwegen en soortgelijk geleid vervoer - Elektromagnetische compatibiliteit - Deel 3-1: Rollend materieel - Treinen en treinstellen
EN 61000-6-4 +A1	2007 2011	Elektromagnetische compatibiliteit (EMC) - Deel 6-4: Algemene normen - Emissienorm voor industriële omgevingen
EN 55016-2-3	2010 2010 2014	Specificatie voor meetontvangers en meetmethoden voor radiostoringen en -immuniteit - Deel 2-3: Methode voor het meten van storingen en immuniteit - Metingen van stralingsstoring
EN 55016-1-4 +A1 +A2	2010 2012 2017	Specificatie voor meetontvangers en meetmethoden voor radiostoringen en -immuniteit - Deel 1-4: Meetapparatuur voor radiostoringen en stralingsstoring - Antennes en test sites voor gestraalde verstoring metingen

2 BEDIENINGSOMSTANDIGHEDEN TIJDENS HET METEN

De volgende bedrijfsmodi/-toestanden van de trein en de spoorbomen zijn onderzocht.

BM nr.	Beschrijving bedrijfstoestanden
1	Versnellen van de trein (stoptrein).
2	Vertragen van de trein (remmen).
3	Normale toestand, de trein rijdt op een bepaalde snelheid (intercity, IC).
4	Spoorbomen zijn gesloten.
5	Spoorbomen veranderen van toestand (gesloten→open).

3 MEETPLAN

In de onderstaande tabel wordt een samenvatting van de uitgevoerde metingen getoond. Raadpleeg figuur 3-1 en 3-2 voor de plaats van de meetpunten.

Nr.	Test	Frequentie/ frequentiebereik	Meetpunt	Afstand tot het spoor/de spoorbomen	Opmerking
1	Emissie uitgestraald <u>magnetisch</u> veld	DC - 5 Hz	Punt-1	0 m	Zie 1)
			Punt-2	1,25 m	Zie 2)
			Punt-3	3 m	Zie 3)
			Punt-4	6 m	Zie 3)
			Punt-5	10 m	Zie 3)
			Punt-6	30 m	---
2	Emissie uitgestraald <u>EM</u> -veld	5 Hz - 30 MHz	Punt-1	Tussen de sporen	Zie 6)
			Punt-2	1,25 m	Zie 2)
			Punt-3	3 m	Zie 3)
			Punt-4	6 m	Zie 4) en 5)
			Punt-5	10 m	Zie 3)
			Punt-6	30 m	---
			Punt-7	0 m (tot spoorbomen)	Zie 4)
			Punt-8	1 m (tot spoorbomen)	Zie 4)
3	Emissie uitgestraald <u>elektrisch</u> veld **)	30 MHz - 1000 MHz	Punt-3	3 m	Zie 3)
			Punt-5	10 m	Zie 3)
			Punt-6	30 m	---
4	Emissie uitgestraald <u>elektrisch</u> veld	1 GHz - 3 GHz	Punt-3	3 m	---
			Punt-5	10 m	Zie 3)
			Punt-6	30 m	---
5	Emissie uitgestraald <u>elektrisch</u> veld	3 GHz - 6 GHz	Punt-3	3 m	---
			Punt-5	10 m	Zie 3)
			Punt-6	30 m	---

- 1) De sensor is onder het spoor geplaatst.
- 2) Dit is de minimale toegestane afstand tot het spoor waarop de meetapparatuur moet worden geplaatst.
- 3) De metingen omvatten ook de verstoringen die worden veroorzaakt door de spoorbomen.
- 4) De metingen zijn uitgevoerd binnen een frequentiebereik van 5 - 400 KHz.
- 5) De metingen zijn uitgevoerd binnen een frequentiebereik van DC - 5 Hz.
- 6) De metingen zijn uitgevoerd binnen een frequentiebereik van 5 Hz - 500 KHz met twee verschillende sensoren/antennes.

Opmerking: Punt-7 en Punt-8 houden verband met de metingen die zijn uitgevoerd bij de spoorbomen.
In de volgende tekening wordt getoond waar de sensoren en antennes (meetpunten) zijn geplaatst. Raadpleeg de volgende hoofdstukken voor meer informatie.

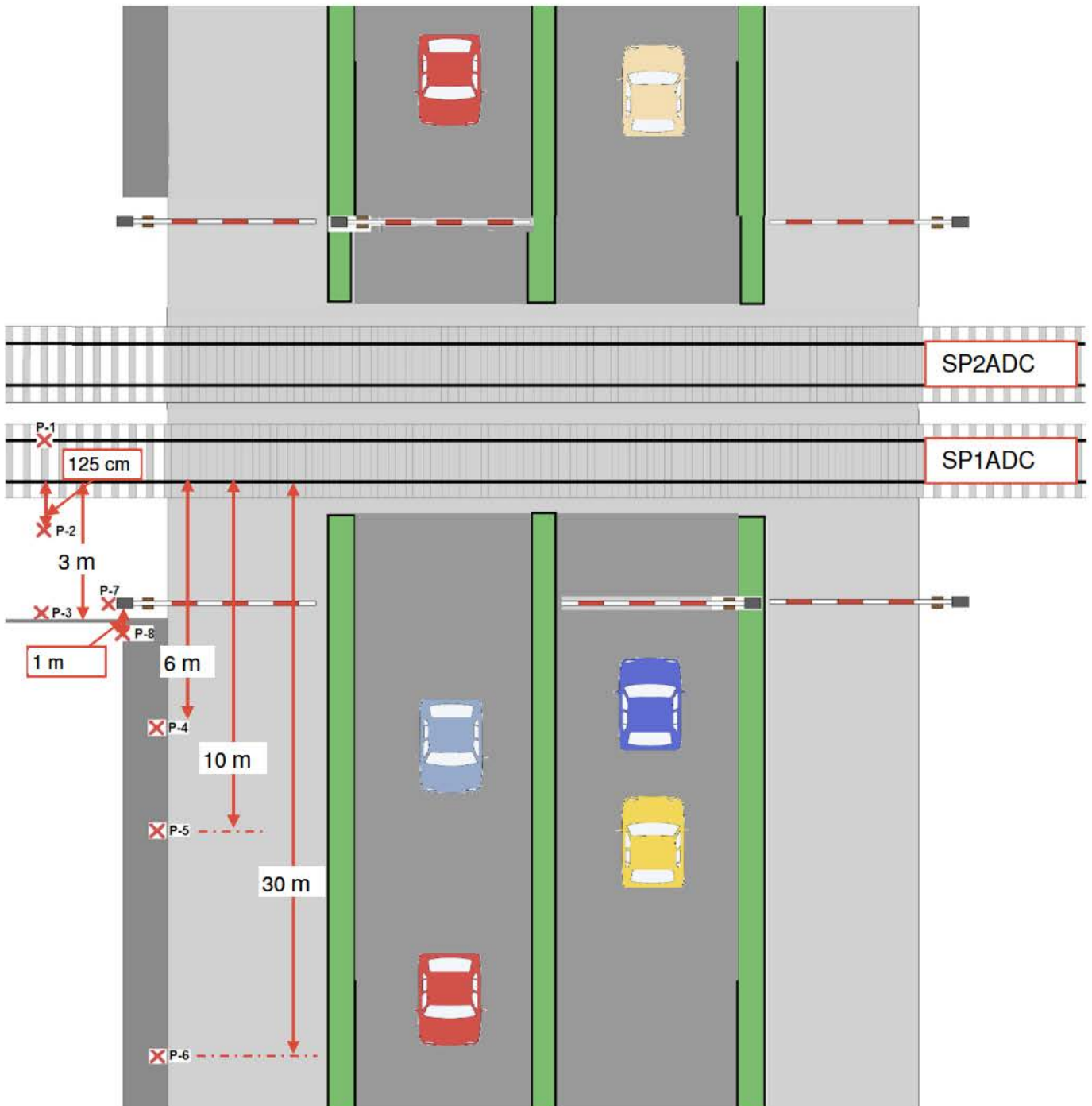

Opmerking: Alle metingen zijn uitgevoerd op spoor SP1ADC

Figuur 3-1: Plaats van de meetpunten.



(De bron van de foto is Google Maps)

Opmerking: Metingen bij Punt-1, -2 en -3 (P-1, P-2 en P-3) zijn uitgevoerd onder toezicht van een beveiligder.

Figuur 3-2: Plaats van de meetpunten getoond op de plek waar de metingen zijn uitgevoerd.

4 MEETRESULTATEN

4.1 Emissie uitgestraald statisch magnetisch veld

Tijdens het meten zijn de uitgestraalde statische magnetische velden veroorzaakt door het spoorwegsysteem, inclusief de trein, gemeten.

Frequentiebereik	DC - 5 Hz
Meetmethode/procedure	DEKRA
Meetpunt(en)	P-1, P-2, P-3, P-4, P-5 en P-6
Bedrijfsstoestand van de trein	1, 2 en 3 (raadpleeg hoofdstuk 2)
Bedrijfsstoestand van de spoorbomen	4 en 5 (raadpleeg hoofdstuk 2)

Gebruikte instrumenten				
Apparatuur	Fabrikant	Model	DEKRA-ID	Kalibratiedatum
Hall Teslameter				08-2018
Sensor met 3 assen				
Magnetometer				09-2018
Sonde met één as (0,2 mT)				
Geavanceerde seriële datalogger				---
ADC - plaat				08-2018
Stroomtang 5000 A				04-2018
Stroomtang 5000 A				04-2018
Dataloggersoftware				-

4.1.1 Testopstellingen en meetprocedure:

De meting is uitgevoerd met twee instrumenten waarvan de sensoren zijn geplaatst op meetpunten die hieronder en in hoofdstuk 3 worden beschreven. Het middelpunt van de sensor op P-1 is onder het gemeten spoor geplaatst en bij punten P-2 tot en met P-6 boven het spoor/de weg, zoals weergegeven in de onderstaande testopstellingen. Om het statische magnetische veld te kunnen meten bij verschillende bedrijfsmodi, hoogten en afstanden, zijn in totaal 200 metingen uitgevoerd.

Om te onderzoeken hoe de sterkte van het statische magnetische veld verandert met betrekking tot de hoogte van de sensor, zijn de metingen bij Punt-2 (P-2) op drie verschillende hoogten en bij Punt-3 (P-3) en Punt-4 (P-4) op twee verschillende hoogten uitgevoerd (zie de onderstaande tabel).

De metingen bij P-2 met een sonde met één as zijn uitgevoerd op respectievelijk de X-, Y- en Z-as. De meetresultaten in de Y-as (sensor parallel aan het spoor) waren niet significant (verwaarloosbaar) vergeleken met de X- en Z-as. Daarom zijn de metingen in de Y-as bij de andere meetpunten weggelaten.

Om de verschillende typen treinen, beladingstoestanden en eventuele andere parameters die van invloed zouden kunnen zijn op het meetresultaat, te kunnen meten, zijn er bij alle meetpunten van P-2 tot en met P-6 minimaal 3 metingen uitgevoerd voor elke as en elke hoogte van de sensor en per bedrijfsstoestand van de trein.

De metingen bij P-1 zijn uitgevoerd door de sensor onder het spoor en op twee afstanden van het spoor te plaatsen, respectievelijk 50 cm en 1 m (zie de onderstaande tabel en figuur 4.1-1). Bij Punt-1 (P-1) was het niet mogelijk om op verschillende hoogten te meten. Om de verschillende typen treinen, beladingstoestanden en eventuele andere parameters die van invloed zouden kunnen zijn op het meetresultaat, te kunnen meten, zijn er in totaal 60 metingen op de genoemde afstanden (0 m, 0,5 m en 1 m) uitgevoerd bij P-1.

De metingen bij P-1 en P-2 zijn met twee verschillende sensoren uitgevoerd. De metingen bij P-1 zijn uitgevoerd met apparatuur met . De metingen bij P-2 zijn uitgevoerd met apparatuur met

Tijdens alle metingen is ook de DC-stroom op de rails/het spoor gemeten. De afgevlakte^{*)} waarden voor stroomsterkte zijn gebruikt.

*) Afgevlakte waarde: De stroomsterkte is gemeten met een bemonsteringsfrequentie van 5120 Hz (waarde bepaald door de AD-plaat). De analyse van de meetgegevens is uitgevoerd met de DiaDem-software van National Instruments. Wanneer DIAdem deze kanalen aflakt, neemt DIAdem 12 waarden aan de rechterkant en 12 waarden aan de linkerkant van de huidige kanaalwaarde op en wordt het rekenkundig gemiddelde van deze waarden berekend. Zo worden korte pieken afgevlakt.

Samenvatting van de metingen									
Treintoestand	Hoogte van de sensor	P-1			P-2	P-3	P-4	P-5	P-6
		Afstand tot het spoor							
		0 m	0,5 m	1 m	1,25 m	3 m	6 m	10 m	30 m
Versnellen	0 cm	X	X	X	---	---	---	---	---
	30 cm	n.v.t.	n.v.t.	n.v.t.	X	X	X	---	---
	70 cm	n.v.t.	n.v.t.	n.v.t.	X	---	---	---	---
	100 cm	n.v.t.	n.v.t.	n.v.t.	X	X	X	X	X
Doorreis	0 cm	X	X	X	---	---	---	---	---
	30 cm	n.v.t.	n.v.t.	n.v.t.	X	X	X	---	---
	70 cm	n.v.t.	n.v.t.	n.v.t.	X		---	---	---
	100 cm	n.v.t.	n.v.t.	n.v.t.	X	X	X	X	X
Remmen	0 cm	X	X	X	---	---	---	---	---
	30 cm	n.v.t.	n.v.t.	n.v.t.	X	---	X	---	---
	70 cm	n.v.t.	n.v.t.	n.v.t.	X	---	---	---	---
	100 cm	n.v.t.	n.v.t.	n.v.t.	---	X	X	---	X

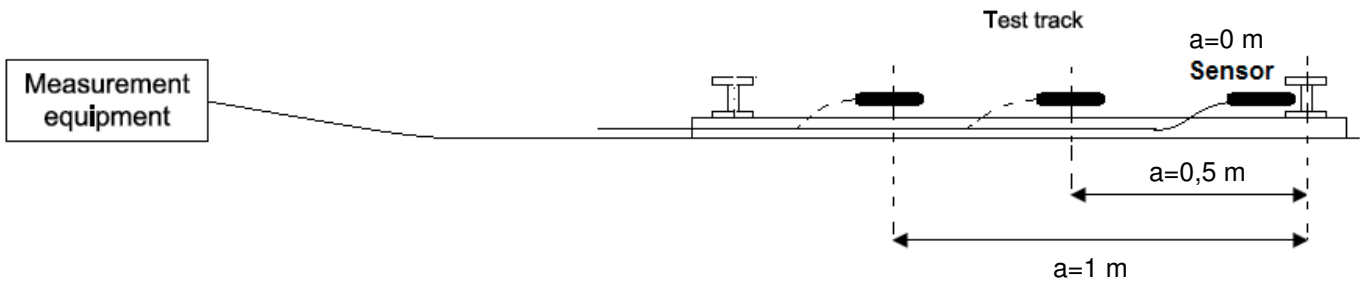

Figuur 4.1-1: Testopstelling voor P-1.

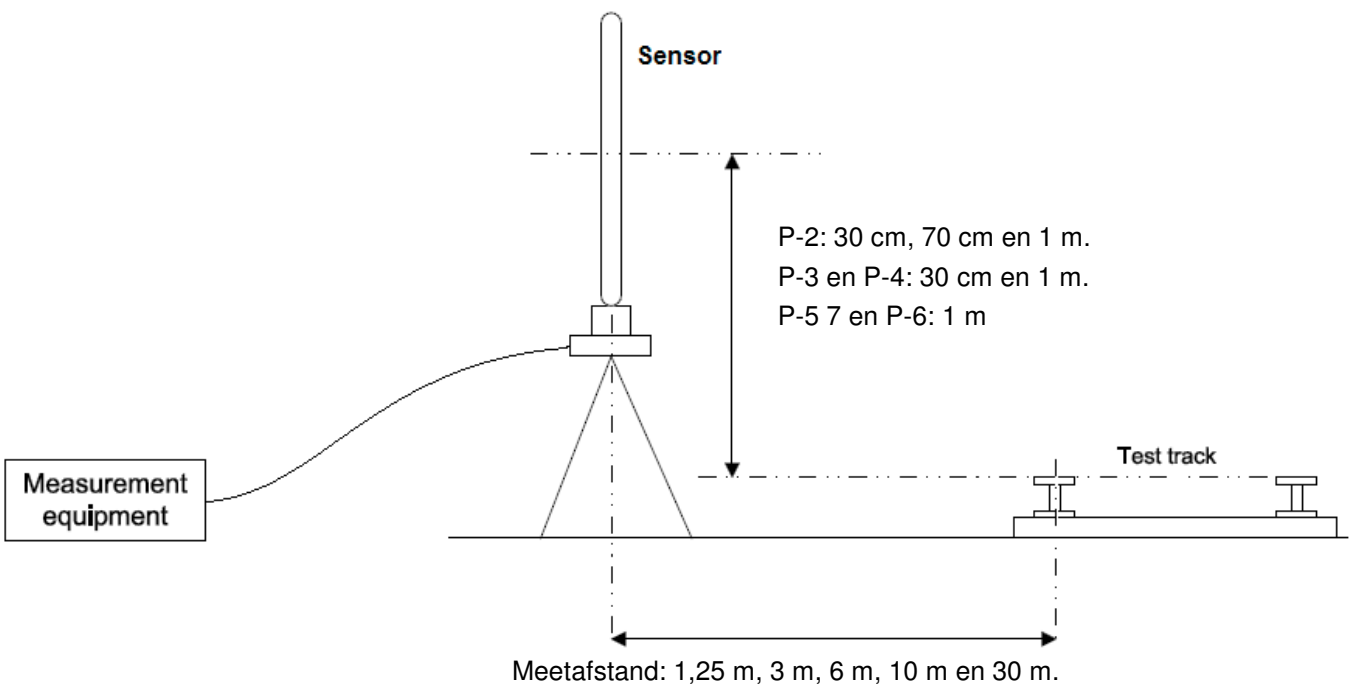

Figuur 4.1-2: Testopstelling voor P-2 tot en met P-6.

4.1.2 Overzicht

- De resultaten die worden vermeld in Bijlage 1 zijn de meest ongunstige resultaten van 200 metingen.
- Het maximale statische magnetische veld dat is gemeten, was 2,574 mT. Deze waarde is gemeten tegen de rails ($h=0$ m, $a=0$ m).
- Hoe verder van het testspoor verwijderd, hoe zwakker het statische magnetische veld.
- Een aanzienlijk sterk statisch magnetisch veld werd gemeten zelfs nadat de trein het station had verlaten en een aantal kilometer had gereden.
- In figuur 4.1-3 wordt de verandering van het statische magnetische veld ten opzichte van de afstand tot het spoor (spoor voor retourstroom) weergegeven. De grafiek in figuur 4.1-3 is verkregen door de maximale gemeten waarden van meetpunten P-1 tot en met P-6 te gebruiken.
- Het is vooral de DC-stroom die door het retourstroom spoor gaat die het grootste aandeel in het totale gemeten magnetische veld heeft. De trein zelf draagt ook bij aan het gemeten veld door statische magnetische velden te creëren. Hoe groot deze bijdrage is, is afhankelijk van het type trein, de versnelling/snelheid en de beladingstoestand van de trein.
- Er is geen significant verschil in de sterkte van het EM-veld als de sensor op een andere hoogte wordt geplaatst.
- De sterkte van het EM-veld dat werd gemeten tijdens het remmen/vertragen van de trein is niet significant (verwaarloosbaar) vergeleken met de omstandigheden tijdens versnelling en doorreis.
- De versnellende treinen (stoptreinen) genereren een hoger statisch magnetisch veld dan doorreizende treinen (intercity's).
- De meetresultaten bij de Y-as (sensor parallel aan het spoor) waren niet significant (verwaarloosbaar) vergeleken met de X- en Z-as. Daarom zijn de metingen bij de Y-as bij de andere meetpunten weggelaten.
- De spoorbomen veroorzaken geen significante verstoringen. Het statische magnetische veld veroorzaakt door de spoorbomen ligt onder het niveau voor omgevingsverstoring.
- Gedetailleerde meetresultaten worden in Bijlage 1 gegeven.

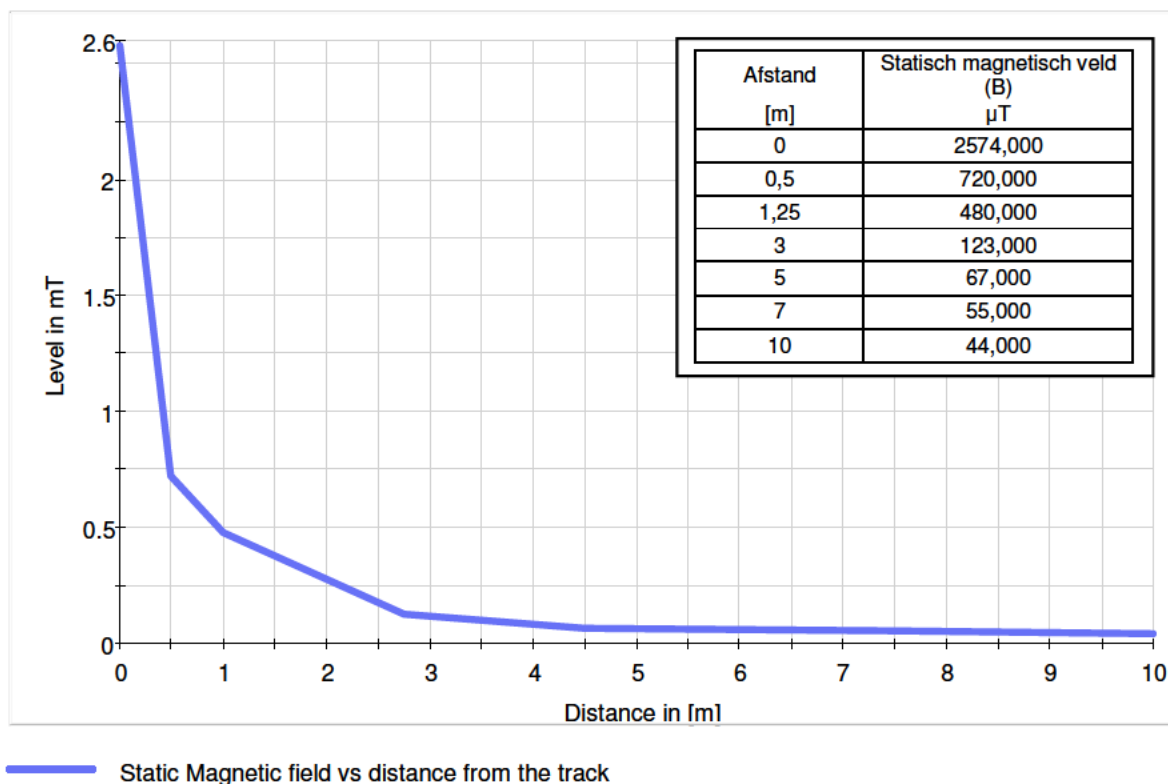

Figuur 4.1-3: Statisch magnetisch veld (gemeten) versus afstand (tot het testspoor)

4.2 Emissie uitgestraald EM-veld, 5 Hz - 30 MHz

Tijdens het meten is het uitgestraalde magnetische veld veroorzaakt door het spoorwegsysteem, inclusief de trein, gemeten.

Frequentiebereik	5 Hz - 30 MHz
Meetmethode/procedure	DEKRA: 5 Hz - 9 KHz EN 50121-normen serie: 9 KHz - 30 MHz
Meetpunt(en)	P-1, P-2, P-3, P-4, P-5, P-6, P-7 en P-8
Meetas	5 Hz - 9 KHz: meting met 3 assen 9 KHz - 30 MHz: X, Y, Z
Bedrijfsstoestand van de trein	1, 2 en 3 (raadpleeg hoofdstuk 2)
Bedrijfsstoestand van de spoorbomen	4 en 5 (raadpleeg hoofdstuk 2)

Gebruikte instrumenten				
Apparatuur	Fabrikant	Model	DEKRA-ID	Kalib.datum
3D H/E-veldmeter				10-2018
Bedieningssoftware				---
EMI-testontvanger				09-2018
EMI-testontvanger				09-2018
Coaxkabel				06-2018
Magnetic loop-antenne				10-2018
Active loop-antenne				09-2018
ADC - plaat				08-2018
Stroomtang 5000 A				04-2018
Stroomtang 5000 A				04-2018
Dataloggersoftware				-

4.2.1 Testopstelling en meetprocedure

De metingen zijn aan de hand van drie verschillende methoden uitgevoerd met de bovenstaande apparatuur. De sensor en antennes zijn geplaatst op meetpunten die hieronder en in hoofdstuk 3 wordt beschreven. De sensor en de antenne(s) op P-1 zijn tussen de rails van het testspoor geplaatst en bij punten P-2 tot en met P-6 boven het spoor/de weg, zoals weergegeven in de onderstaande testopstellingen. Om het magnetische en elektrische veld te kunnen meten bij verschillende bedrijfsmodi, hoogten en afstanden, zijn in totaal 220 metingen uitgevoerd.

Om te onderzoeken hoe de sterkte van het EM-veld verandert met betrekking tot de hoogte van de sensor, zijn de metingen bij Punt-2 en Punt-3 op twee verschillende hoogten en bij andere punten bij één sensor-/antennehoogte uitgevoerd (zie de onderstaande tabel).

De EM-velden veroorzaakt door de spoorbomen zijn ook gemeten. De metingen zijn uitgevoerd met een 3D-veldmeter) binnen een frequentiebereik van 5 Hz - 400 KHz en zijn uitgevoerd op 0 m en 1 m afstand op een hoogte van 1,55 m. Vanwege de locatie van de antenne omvatten de metingen die zijn uitgevoerd met de active loop-antenne) binnen een frequentiebereik van 9 KHz - 30 MHz ook de EM-velden uitgestraald door de spoorbomen.

De metingen die zijn uitgevoerd met de active loop-antenne () zijn uitgevoerd bij respectievelijk de X-, Y- en Z-as.

Om de verschillende typen treinen, beladingstoestanden en eventuele andere parameters die van invloed zouden kunnen zijn op het meetresultaat, te kunnen meten, zijn er bij meetpunten P-2 minimaal 3 metingen uitgevoerd voor elke as en de hoogte van de sensor en de bedrijfstoestand van de trein.

De metingen bij P-1 zijn uitgevoerd door de sensor/antenne tussen de rails van het testspoor te plaatsen (zie de foto's in Bijlage 5: Foto's) Om de verschillende typen treinen, beladingstoestanden en eventuele andere parameters die van invloed zouden kunnen zijn op het meetresultaat, te kunnen meten, zijn er langetermijmetingen uitgevoerd, waaronder alle bedrijfstoestanden van de trein en de spoorbomen). De metingen die zijn uitgevoerd met de spectrumanalyzer zijn uitgevoerd met een PK-piekdetector en de functie "Max-Hold".

De metingen bij Punt-4 zijn alleen uitgevoerd met de 3D-veldmeter () binnen een frequentiebereik van 5 Hz - 400 KHz).

Tijdens alle metingen is ook de DC-stroom op de rails/het spoor gemeten. De afgevlakte^{*)} waarden voor stroomsterkte zijn gebruikt.

*) Afgevlakte waarde: De stroomsterkte is gemeten met een bemonsteringsfrequentie van 5120 Hz (waarde bepaald door de AD-plaat). De analyse van de meetgegevens is uitgevoerd met de DiaDem-software van National Instruments. Wanneer DIAdem deze kanalen afvlakt, neemt DIAdem 12 waarden aan de rechterkant en 12 waarden aan de linkerkant van de huidige kanaalwaarde op en wordt het rekenkundig gemiddelde van deze waarden berekend. Zo worden korte pieken afgevlakt.

Samenvatting van de metingen									
Toestand trein/spoorbomen	Hoogte van de sensor/antenne	P-1	P-2	P-3	P-4	P-5	P-6	P-7	P-8
		Afstand tot het spoor							
		0 m (tussen de sporen)	1,25 m	3 m	6 m	10 m	30 m	0 m	1 m
Versnellen	0 cm	X	---	---	---	---	---	---	---
	30/50* cm	---	X	X	---	---	---	---	---
	100 cm	---	X	X		X	X	---	---
	150 cm	---	---	---	X	---	---	---	---
Doorreis	0 cm	X		---	---	---	---	---	---
	30/50* cm	---		X	---	---	---	---	---
	100 cm	---		X	---	X	X	---	---
	150 cm	---		---	X	---	---	---	---
Remmen	0 cm	X		---	---	---	---	---	---
	30/50* cm	---		X	---	---	---	---	---
	100 cm	---		X		X	X	---	---
	150 cm	---		X	X	---	---	---	---
Spoorbomen zijn gesloten	155 cm	---	---	---	---	---	---	X	X
Spoorbomen veranderen van toestand (gesloten→open).	155 cm	---	---	---	---	---	---	X	X

* Hoogte van de active loop-antenne ()

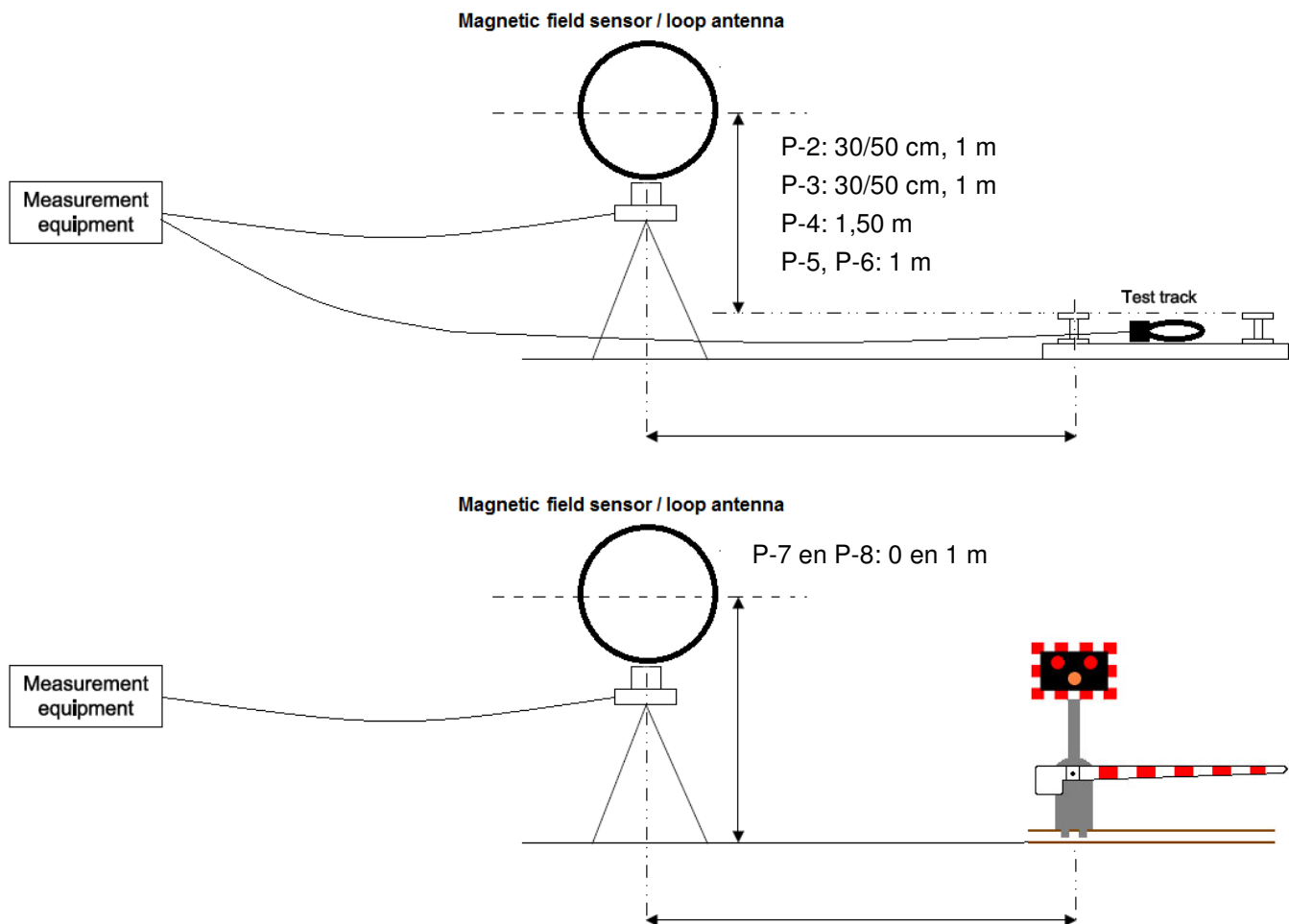

Figuur 4.2-1: Testopstellingen

4.2.2 Overzicht

- De resultaten die worden vermeld in Bijlage 2 zijn de meest ongunstige resultaten van 220 metingen.
- Er is geen significant verschil in de sterkte van het EM-veld als de sensor en antennes op een andere hoogte worden geplaatst.
- De sterkte van de EM-velden die werden gemeten tijdens het remmen/vertragen van de trein, zijn niet significant (verwaarloosbaar) vergeleken met de omstandigheden tijdens versnelling en doorreis.
- De spoorbomen veroorzaken geen significante EM-verstoringen. De EM-velden veroorzaakt door de spoorbomen liggen onder het niveau voor omgevingsverstoring.
- De versnellende treinen (stoptreinen) genereren een hoger statisch magnetisch veld dan doorreizende treinen (intercity's).
- Het maximale elektrische veld gemeten binnen het frequentiebereik van 5 Hz - 400 KHz was 97,7 V/m.
- Het maximale magnetische veld gemeten binnen het frequentiebereik van 5 Hz - 400 KHz was 23,35 μ T.
- Op 10 m afstand van het spoor hebben we een elektrisch veld van meer dan 10 V/m gemeten. De sterkten van het magnetische veld op deze afstand zijn relatief klein vergeleken met 1 m en 3 m afstand.
- Het spoorwegsysteem, vooral versnellende treinen, veroorzaken een toename (vergeleken met het omgevingsniveau) in de sterkte van het magnetische veld tijdens de metingen die werden uitgevoerd binnen het frequentiebereik van 9 KHz - 30 MHz met een active loop-antenne).
Raadpleeg de afbeelding met meetresultaten in Bijlage 2.
- De metingen die zijn uitgevoerd binnen het frequentiebereik van 9 KHz - 30 MHz met de active loop-antenne () op 10 m afstand van het spoor omvatten ook de limietwaarden zoals gedefinieerd in de reeks EN 50121-normen. Er zijn geen limieten gedefinieerd voor meetafstanden anders dan 10 m.
- Om een vergelijking te kunnen maken en om een beter overzicht te geven van het aandeel van het spoorwegsysteem, omvatten alle grafieken binnen een frequentiebereik van 9 KHz - 30 MHz ook de sterkte van het magnetische veld veroorzaakt door de omgeving.
- Gedetailleerde meetresultaten worden in Bijlage 2 gegeven.

4.3 Emissie uitgestraald elektrisch veld, 30 MHz - 1000 MHz

Tijdens het meten is het uitgestraalde elektrische veld veroorzaakt door het spoorwegsysteem, inclusief de trein, gemeten.

Frequentiebereik	30 MHz - 1000 MHz
Meetmethode/procedure	EN 50121-1, EN 50121-2, EN 50121-3-1
Meetpunt(en)	P-3, P-5 en P-6
Polarisatie antenne	Horizontaal en verticaal
Bedrijfsstoestand van de trein	1, 2 en 3 (raadpleeg hoofdstuk 0)
Bedrijfsstoestand van de spoorbomen	4 en 5 (raadpleeg hoofdstuk 0)

Gebruikte instrumenten				
Apparatuur	Fabrikant	Model	DEKRA-ID	Kalib.datum
EMI-testontvanger				09-2018
EMI-testontvanger				09-2018
Antenne				09-2017
Coaxkabel				06-2018
Coaxkabel				03-2018
Testsoftware				---
ADC - plaat				8-2018
Stroomtang 5000 A				4-2018
Stroomtang 5000 A				4-2018
Dataloggersoftware				-

4.3.1 Testopstelling en meetprocedure:

De metingen zijn uitgevoerd met een BiLog-antenne die op de verschillende meetpunten is geplaatst. Het elektrische veld bij horizontale en verticale polarisatie van de meetantenne is gemeten op meetpunten die in hoofdstuk 3 worden genoemd. De metingen zijn uitgevoerd met een PK-piekdetector en de functie "Max-Hold" van de spectrumanalyzer. De gebruikte testopstellingen worden hieronder getoond.

Vorbereidende metingen zijn uitgevoerd om de RF-veldsterkte tussen de bedrijfsmodi van de trein (versnellen, doorreis en remmen/vertragen) te onderzoeken. De resultaten zijn vergeleken.

De RF-velden veroorzaakt door de spoorbomen zijn ook onderzocht. De metingen uitgevoerd bij P-5 en P-6 omvatten ook de sterkte van de RF-velden veroorzaakt door de spoorbomen.

Om de RF-velden in de omgeving te kunnen meten, zijn langetermijnmetingen in verschillende richtingen (westen, oosten, zuiden) bij P-6 uitgevoerd met de functie "Max-Hold".

Tijdens alle metingen is ook de DC-stroom op de rails/het spoor gemeten. De afgevlakte*) waarden voor stroomsterkte zijn gebruikt.

*) Afgevlakte waarde: De stroomsterkte is gemeten met een bemonsteringsfrequentie van 5120 Hz (waarde bepaald door de AD-plaat). De analyse van de meetgegevens is uitgevoerd met de DIADem-software van National Instruments. Wanneer

DIAdem deze kanalen afvlakt, neemt DIAdem 12 waarden aan de rechterkant en 12 waarden aan de linkerkant van de huidige kanaalwaarde op en wordt het rekenkundig gemiddelde van deze waarden berekend. Zo worden korte pieken afgevlakt.

Samenvatting van de metingen							
Toestand trein/spoorbomen	Hoogte van de antenne	P-3		P-5		P-6	
		Afstand tot het spoor en antennepolarisatie					
		3 m		10 m		30 m	
		HOR	VER	HOR	VER	HOR	VER
Versnellen	2 m	X	X	---	---	---	---
	2,5 m	---	---	X	X	---	---
	3 m	---	---	---	---	X	X
Doorreis	2 m	X	X	---	---	---	---
	2,5 m	---	---	X	X	---	---
	3 m	---	---	---	---	X	X
Remmen	2 m	X	X	---	---	---	---
	2,5 m	---	---	X	X	---	---
	3 m	---	---	---	---	X	X
Spoorbomen zijn gesloten	2 m	X	X	---	---	---	---
	2,5 m	---	---	X	X	---	---
	3 m	---	---	---	---	X	X
Spoorbomen veranderen van toestand (gesloten→open).	2 m	X	X	---	---	---	---
	2,5 m	---	---	X	X	---	---
	3 m	---	---	---	---	X	X

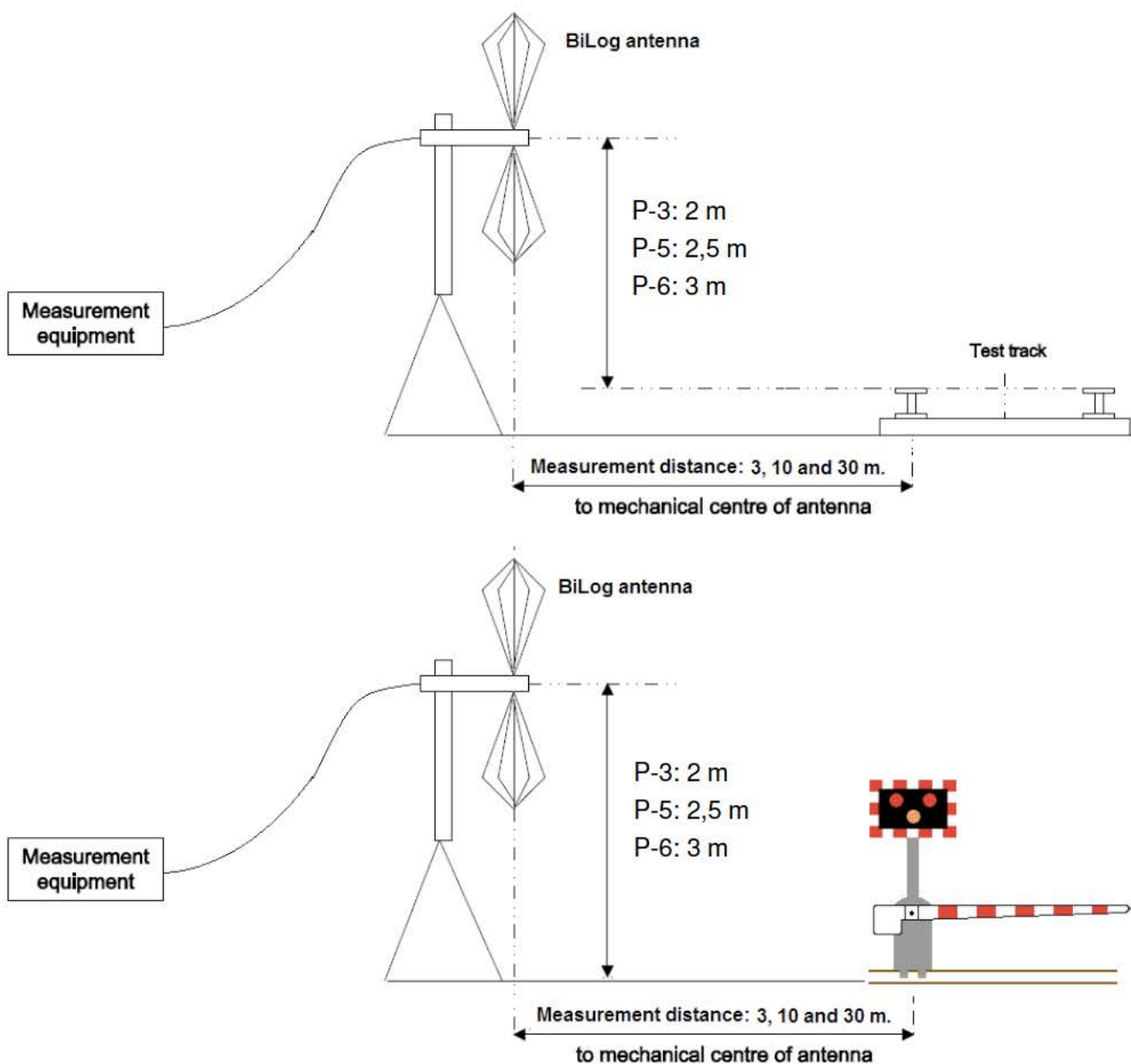

Figuur 4.3-1: Testopstellingen.

4.3.2 Overzicht

- De resultaten die worden vermeld in Bijlage 3 zijn de meest ongunstige resultaten.
- De sterkte van het elektrische veld dat werd gemeten tijdens het remmen/vertragen van de trein is niet significant (verwaarloosbaar) vergeleken met de omstandigheden tijdens versnelling en doorreis.
- De spoorbomen veroorzaken geen significante elektrische veldsterkten. Het elektrische veld veroorzaakt door de spoorbomen ligt onder het niveau voor omgevingsverstoring.
- Over het algemeen genereren de versnellende treinen (stoptreinen) een hoger elektrisch veld dan doorreizende treinen (intercity's).
- Het spoorwegsysteem, vooral versnellende treinen, veroorzaken een toename (vergeleken met het omgevingsniveau) in de sterkte van het elektrische veld tijdens de metingen die werden uitgevoerd binnen het frequentiebereik van 30 - 1000 MHz met een BiLog-antenne). Raadpleeg de grafiek met meetresultaten in Bijlage 3.
- De metingen die zijn uitgevoerd binnen het frequentiebereik van 30 - 1000 MHz met de BiLog-antenne) op 10 m afstand van het spoor omvatten ook de limietwaarden zoals gedefinieerd in de reeks EN 50121-normen. Er zijn geen limieten gedefinieerd voor meetafstanden anders dan 10 m. De sterkte van alle gemeten elektrische velden ligt onder de limietwaarde, met uitzondering van omgevingsverstoringen bij de aangewezen RF-banden (mobiele telefoons, zendstations, enzovoort). Een aantal van de gemeten elektrische velden (RF-verstoringen), zijn afkomstig van mensen die met de trein reizen en hun mobiele telefoon gebruiken.
- Om een vergelijking te kunnen maken en om een beter overzicht te geven van het aandeel van het spoorwegsysteem, omvatten alle grafieken in Bijlage 3 ook de sterkte van het elektrische veld veroorzaakt door de omgeving.
- Gedetailleerde meetresultaten worden in Bijlage 3 gegeven.

4.4 Emissie uitgestraald elektrisch veld, 1 - 6 GHz

Tijdens het meten is het uitgestraalde elektrische veld veroorzaakt door het spoorwegsysteem, inclusief de trein, gemeten.

Frequentiebereik	1 - 6 GHz
Meetmethode/procedure	EN 55016-2-3, EN 55016-1-4, EN 61000-6-4
Meetpunt(en)	P-3, P-5 en P-6
Polarisatie antenne	Horizontaal en verticaal
Bedrijfsstoestand van de trein	1, 2 en 3 (raadpleeg hoofdstuk 0)
Bedrijfsstoestand van de spoorbomen	4 en 5 (raadpleeg hoofdstuk 0)

Gebruikte instrumenten				
Apparatuur	Fabrikant	Model	DEKRA-ID	Kalib.datum
EMI-testontvanger				09-2018
EMI-testontvanger				09-2018
Hoornantenne				10-2018
Coaxkabel				03-2018
Testsoftware				---
ADC - plaat				08-2018
Stroomtang 5000 A				04-2018
Stroomtang 5000 A				04-2018
Dataloggersoftware				-

4.4.1 Testopstelling en meetprocedure:

De metingen zijn uitgevoerd met een hoornantenne die respectievelijk op de meetpunten is geplaatst. Het elektrische veld bij horizontale en verticale polarisatie van de meetantenne is gemeten op meetpunten die in hoofdstuk 3 worden genoemd. De metingen zijn uitgevoerd met een PK-piekdetector en de functie "Max-Hold" van de spectrumanalyzer. De gebruikte testopstellingen worden hieronder getoond.

Vorbereidende metingen zijn uitgevoerd om de RF-veldsterkte tussen de bedrijfsmodi van de trein (versnellen, doorreis en remmen/vertragen) te onderzoeken. De resultaten zijn vergeleken.

De RF-velden veroorzaakt door de spoorbomen zijn ook onderzocht. De metingen uitgevoerd bij P-5 en P-6 omvatten ook de sterkte van de RF-velden veroorzaakt door de spoorbomen.

Om de RF-velden in de omgeving te kunnen meten, zijn langetermijnmetingen in verschillende richtingen (westen, oosten, zuiden) bij P-6 uitgevoerd met de functie "Max-Hold".

Tijdens alle metingen is ook de DC-stroom op de rails/het spoor gemeten. De afgevlakte^{*)} waarden voor stroomsterkte zijn gebruikt.

*) Afgevlakte waarde: De stroomsterkte is gemeten met een bemonsteringsfrequentie van 5120 Hz (waarde bepaald door de AD-plaat). De analyse van de meetgegevens is uitgevoerd met de DiaDem-software van National Instruments. Wanneer DIAdem deze kanalen afvlakt, neemt DIAdem 12 waarden aan de rechterkant en 12 waarden aan de linkerkant van de huidige kanaalwaarde op en wordt het rekenkundig gemiddelde van deze waarden berekend. Zo worden korte pieken afgevlakt.

Samenvatting van de metingen							
Toestand trein/spoorbomen	Hoogte van de antenne	P-3		P-5		P-6	
		Afstand tot het spoor en antennepolarisatie					
		3 m		10 m		30 m	
		HOR	VER	HOR	VER	HOR	VER
Versnellen	2 m	X	X	---	---	---	---
	2,5 m	---	---	X	X	---	---
	2,5 m	---	---	---	---	X	X
Doorreis	2 m	X	X	---	---	---	---
	2,5 m	---	---	X	X	---	---
	2,5 m	---	---	---	---	X	X
Remmen	2 m	X	X	---	---	---	---
	2,5 m	---	---	X	X	---	---
	2,5 m	---	---	---	---	X	X
Spoorbomen zijn gesloten	2 m	X	X	---	---	---	---
	2,5 m	---	---	X	X	---	---
	2,5 m	---	---	---	---	X	X
Spoorbomen veranderen van toestand (gesloten→open).	2 m	X	X	---	---	---	---
	2,5 m	---	---	X	X	---	---
	2,5 m	---	---	---	---	X	X

*) De metingen met de hoornantenne binnen het frequentiebereik 1 - 6 GHz zijn uitgevoerd op een antennehoogte van 2,5 m.

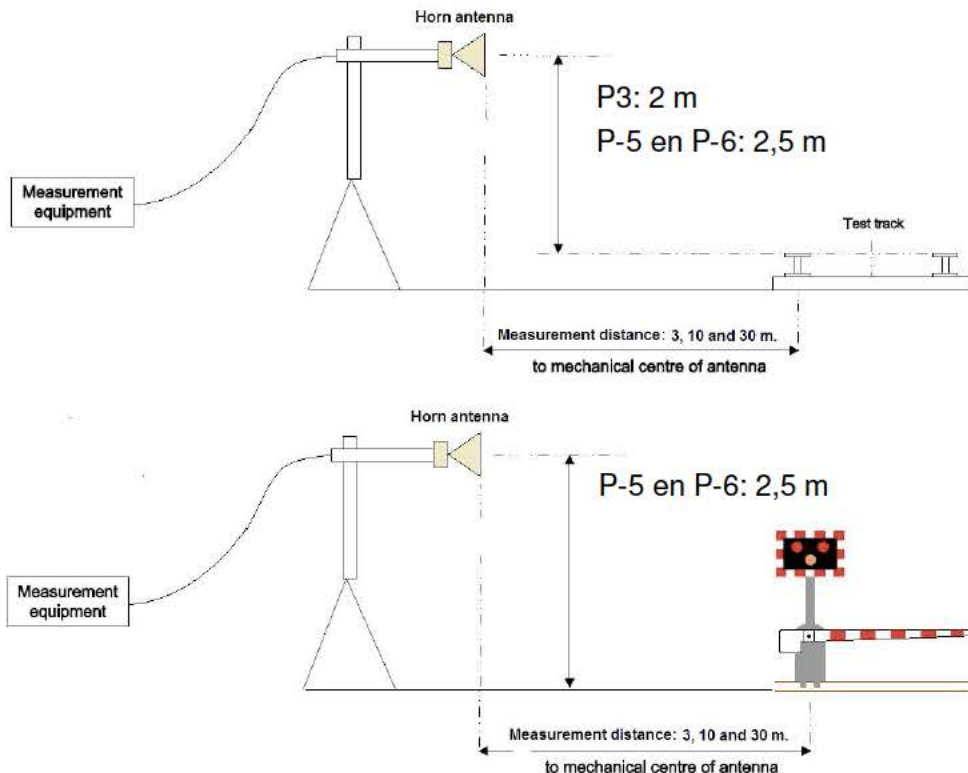

Figuur 4.4-1: Testopstellingen.

4.4.2 Overzicht

- De resultaten die worden vermeld in Bijlage 4 zijn de meest ongunstige resultaten.
- Er is geen elektrisch veld van een significante sterkte gemeten veroorzaakt door het spoorwegsysteem en de spoorbomen binnen het frequentiebereik van 1 - 6 GHz.
- Om een vergelijking te kunnen maken en om een beter overzicht te geven van het aandeel van het spoorwegsysteem, omvatten alle grafieken in Bijlage 4 ook de sterkte van het elektrische veld veroorzaakt door de omgeving.
- Gedetailleerde meetresultaten worden in Bijlage 4 gegeven.

ANNEX 1: RADIATED STATIC MAGNETIC FIELD MEASUREMENT RESULTS

A1.1 Stoptrain (acceleration), h=0 m., d=0 m.

Date & Time	Direction	Operating condition / Train type	Train serial #		Estimated current during test [A]		Distance to track [m]	Height - sensor [m]	Remark
			1	2	Min	Max			
2018/11/19 11:51	W => O ¹⁾	Stoptrain / Flirt	2221	2227	-226	1350	0	0	P-1

¹⁾ Oss-West => Oss

Current data:

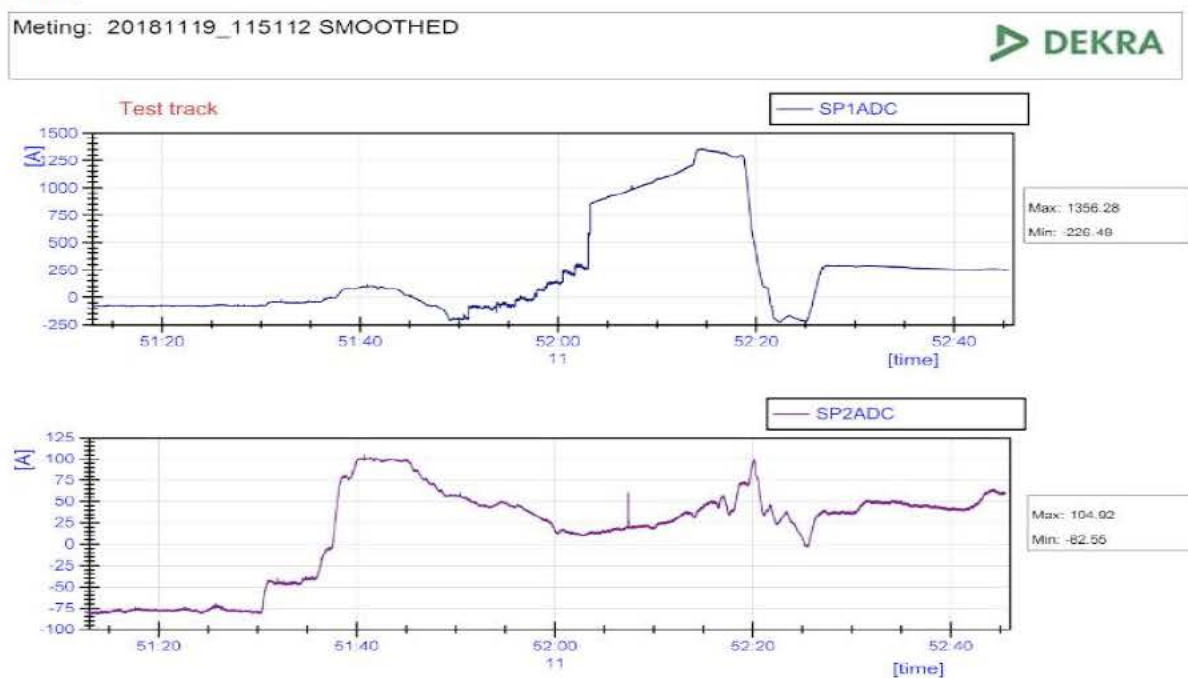

Measurement graphic:

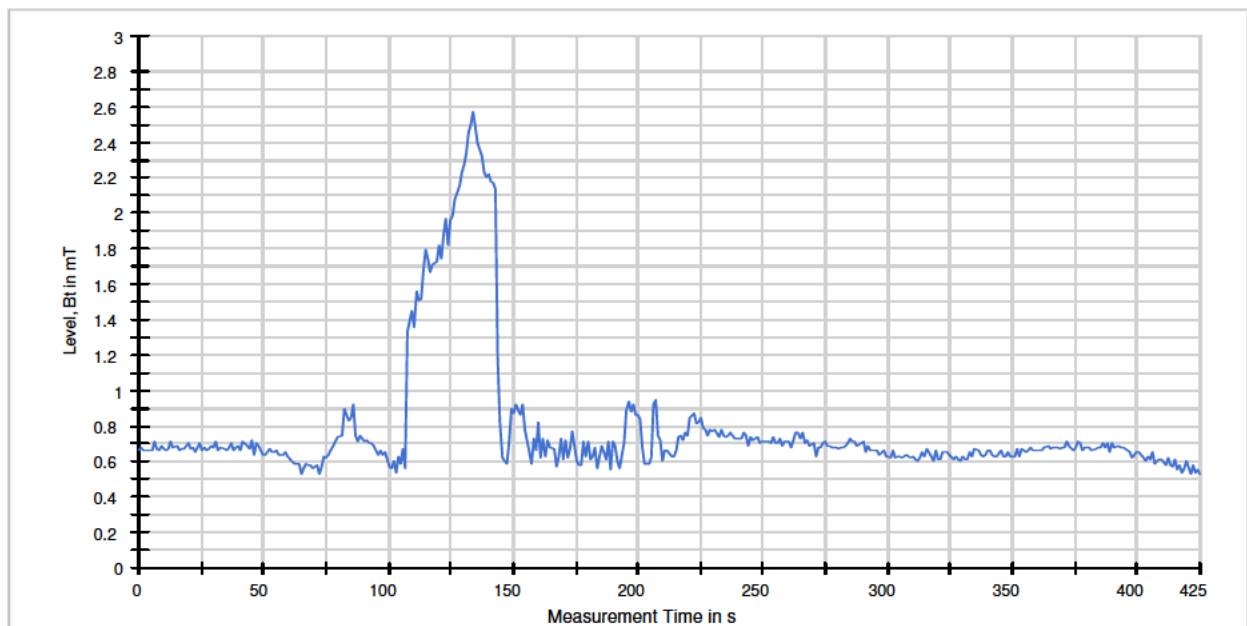

The graphic given above gives information about the frequency spectrum of the magnetic field measured. The dominant frequency is 0 Hz (DC).

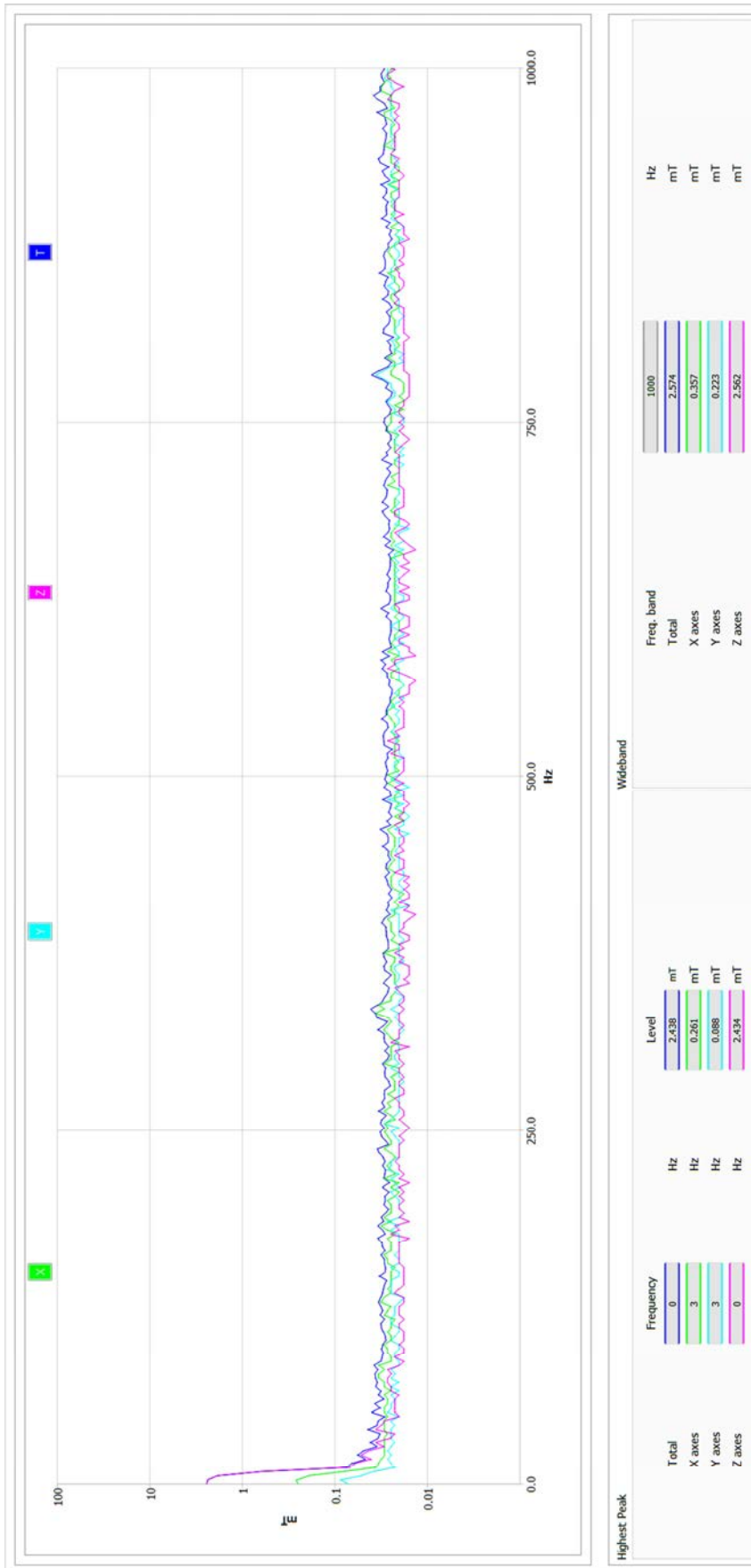

Date & Time	Direction	Operating condition / Train type	Train serial #		Estimated current during test [A]		Distance to track [m]	Height - sensor [m]	Remark
			1	2	Min	Max			
2018/11/19 11:17	W => O ¹⁾	Stoptrein / Flirt	2508	2223	-890	740	0	0	P-1

¹⁾ Oss-West => Oss

Current data:

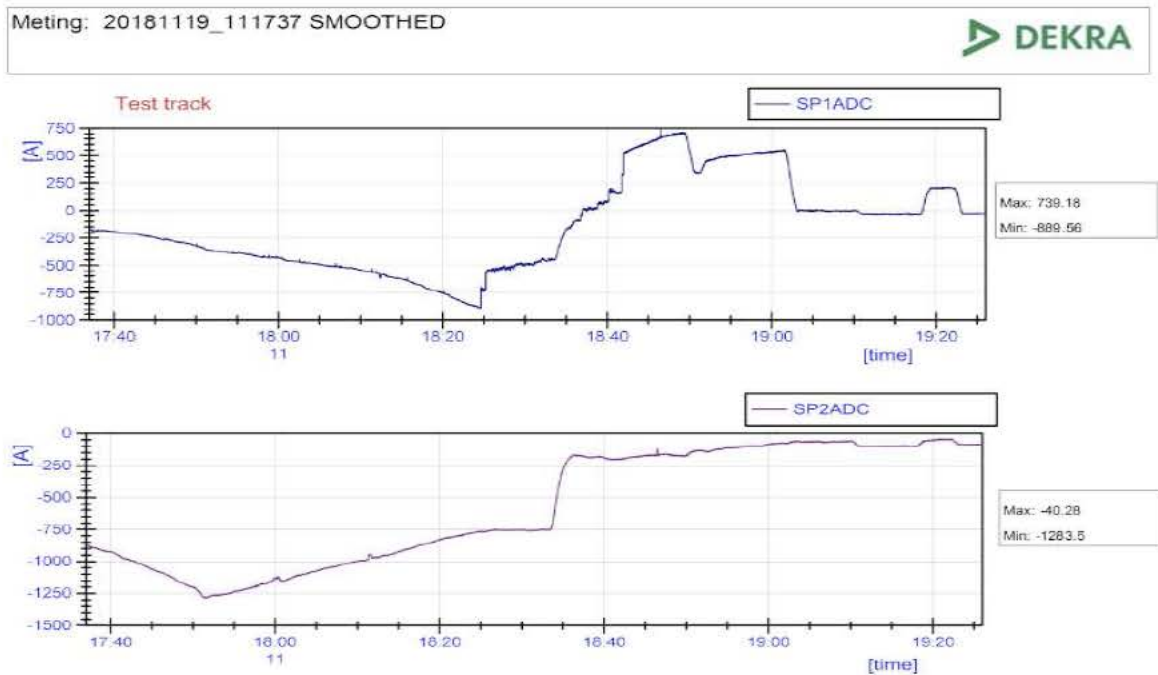

Measurement graphic:

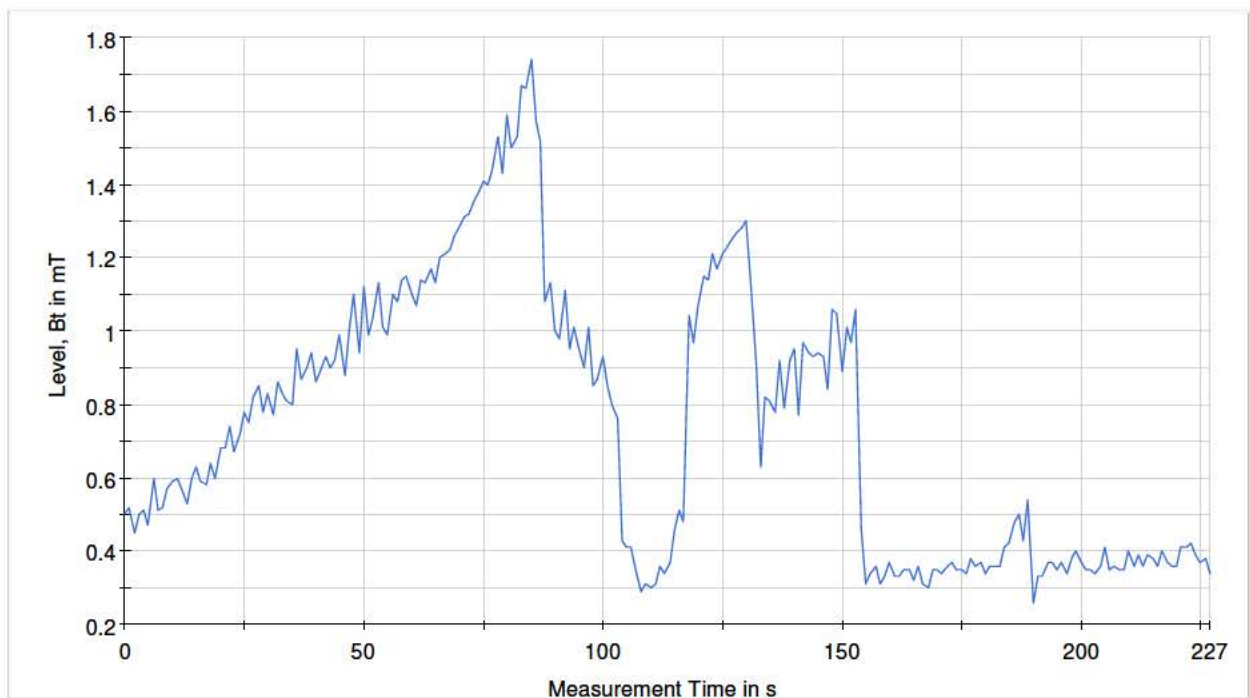

Date & Time	Direction	Operating condition / Train type	Train serial #		Estimated current during test [A]		Distance to track [m]	Height - sensor [m]	Remark
			1	2	Min	Max			
2018/11/19 12:19	W => O	Stoptrein Flirt	2507	2211	-319	668	0	0	P-1

Current data:

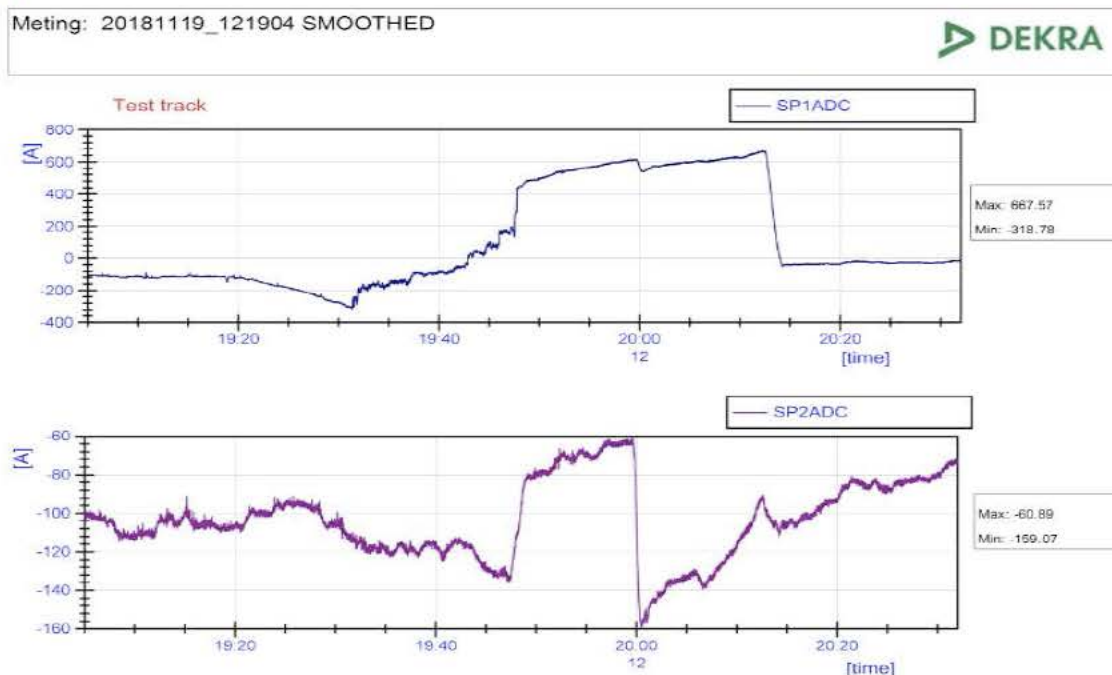

Measurement graphic:

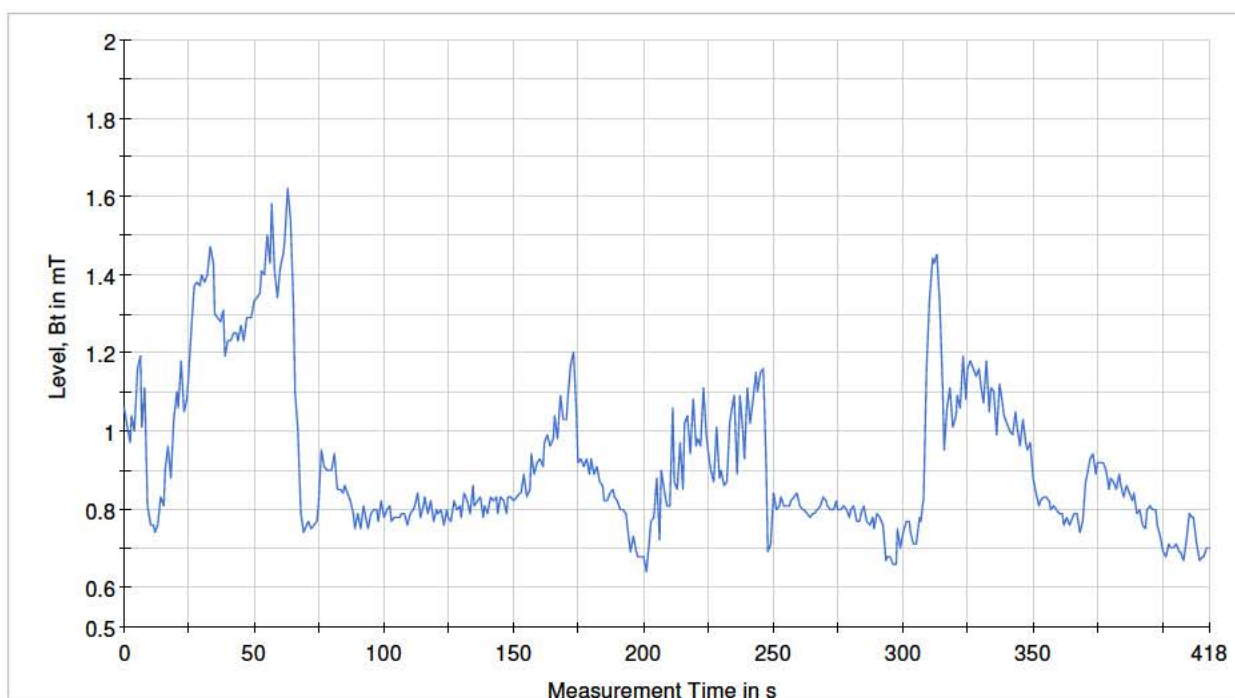

Date & Time	Direction	Operating condition / Train type	Train serial #		Estimated current during test [A]		Distance to track [m]	Height - sensor [m]	Remark
			1	2	Min	Max			
2018/11/21 17:28	W=>O O=>W	Stoptrein (accel) / Flirt	2202 ---	2213 ---	-98 -914	-627 -244	0	0	P-1, See 1)

1) Acceleration of two trains. Acceleration train on track SP1ADC and acceleration train on track SP2ADC.

Current data:

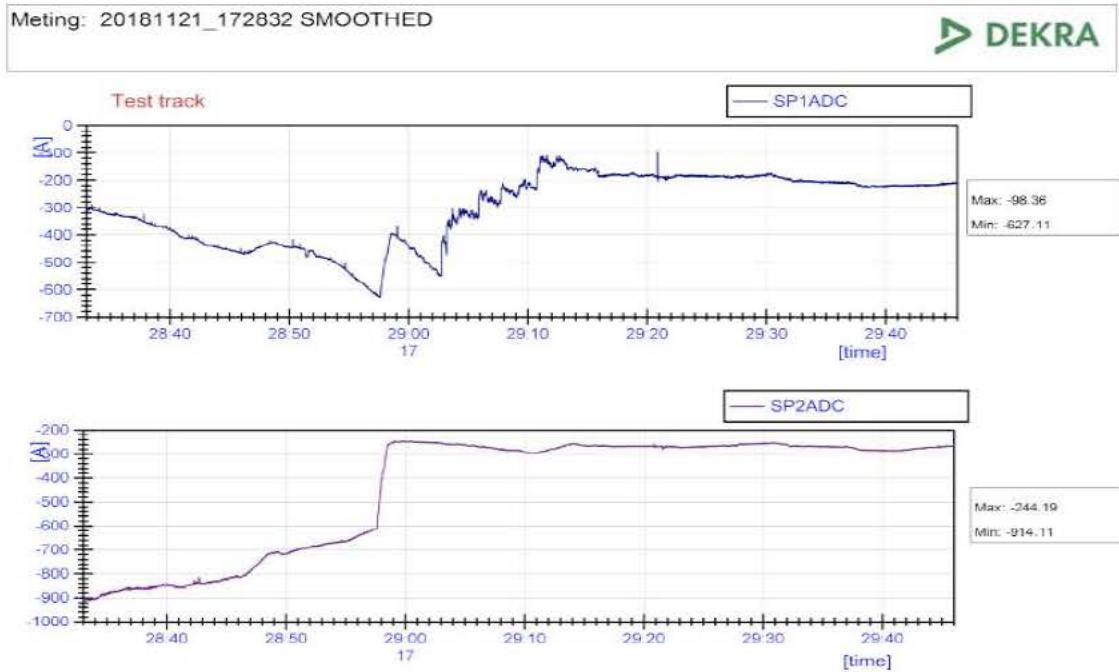

Measurement graphic:

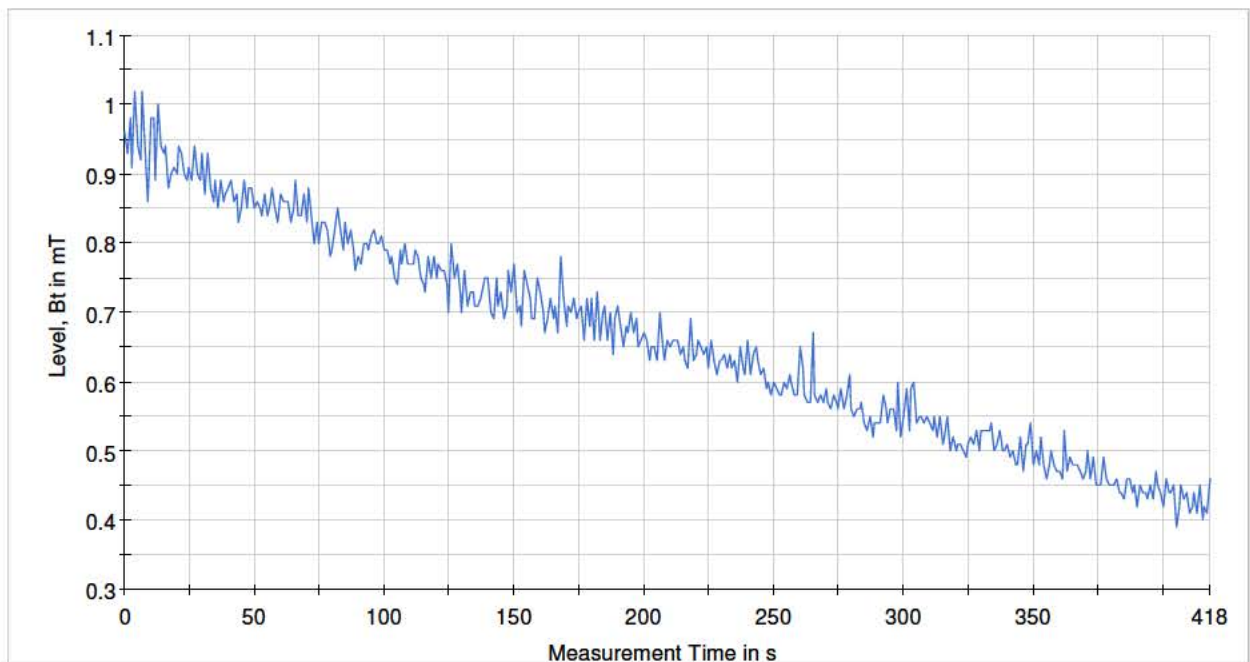

— Accel of 2 trains-M25

Date & Time	Direction	Operating condition / Train type	Train serial #		Estimated current during test [A]		Distance to track [m]	Height - sensor [m]	Remark
			1	2	Min	Max			
2018/11/21 19:17	W=>O	Stoptrein Flirt	2222	2525	-534	827	0	0	P-1

Current data:

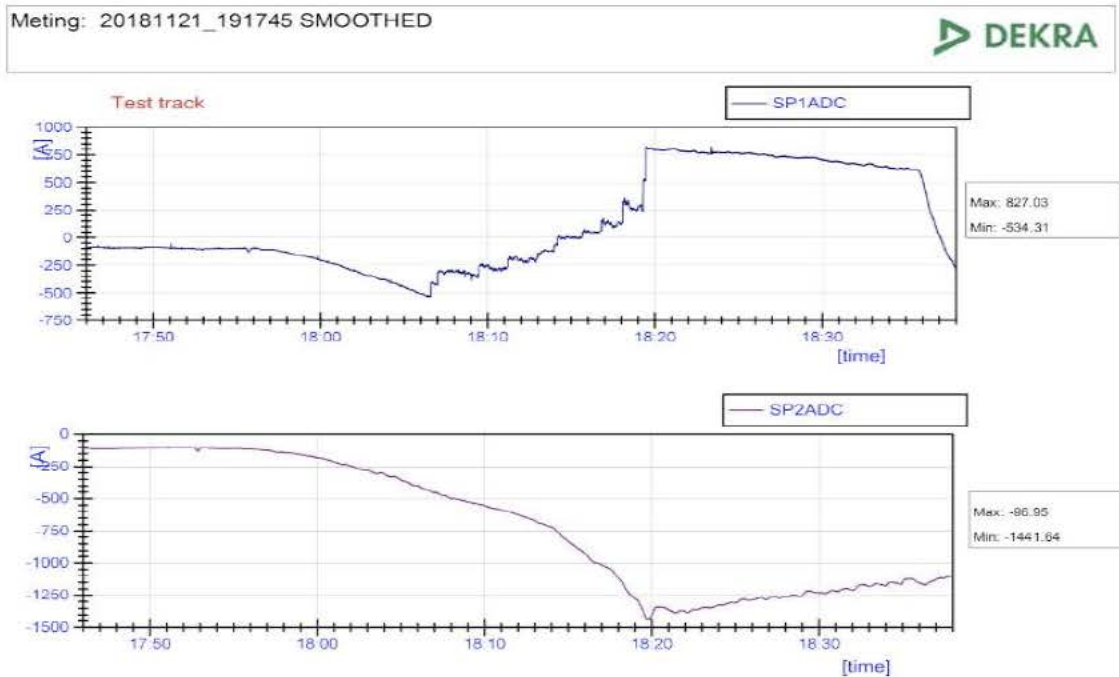

Measurement graphic:

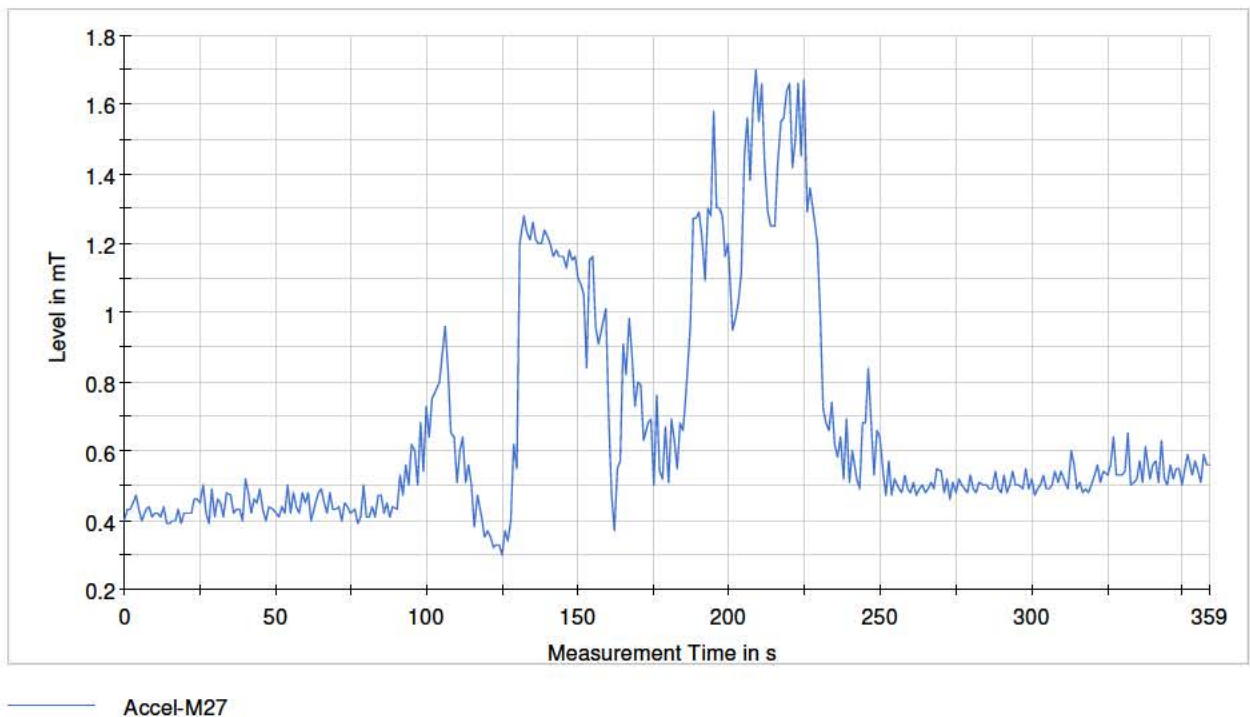

A1.2 Intercity-IC (transit), h=0 m., d=0 m.

Date & Time	Direction	Operating condition / Train type	Train serial #		Estimated current during test [A]		Distance to track [m]	Height - sensor [m]	Remark
			1	2	Min	Max			
2018/11/19 11:04	W => O	Intercity-IC (transit) / DDZ	7612	---	-212	67	0	0	P-1

Current data:



Measurement graphic:

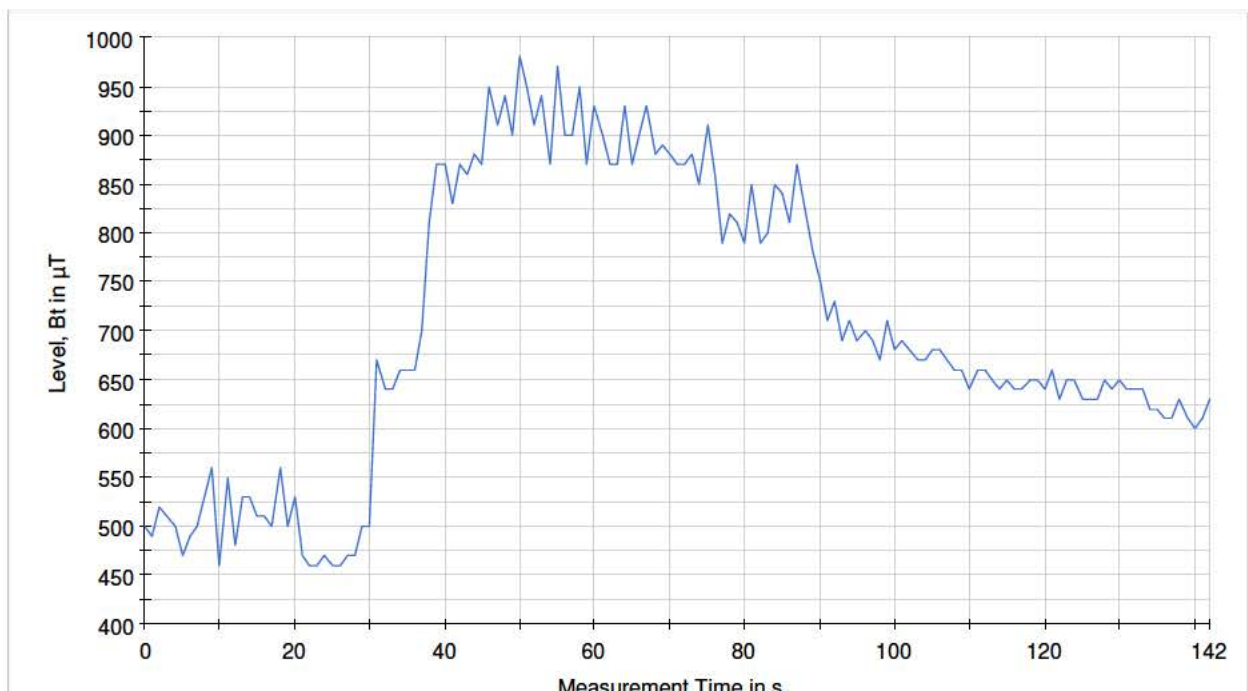

Date & Time	Direction	Operating condition / Train type	Train serial #		Estimated current during test [A]		Distance to track [m]	Height - sensor [m]	Remark
			1	2	Min	Max			
2018/11/19 11:35	W => O	Intersity-IC (transit) / VIRM	---	---	-345	556	0	0	P-1

Current data:

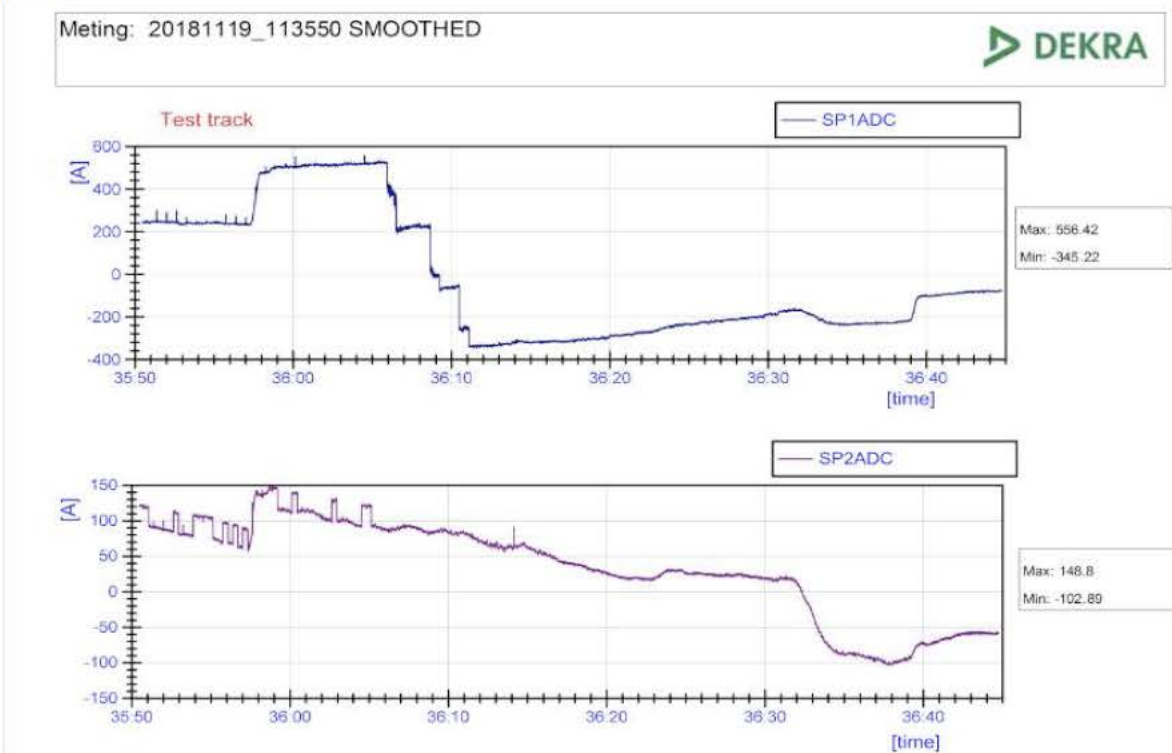

Measurement graphic:

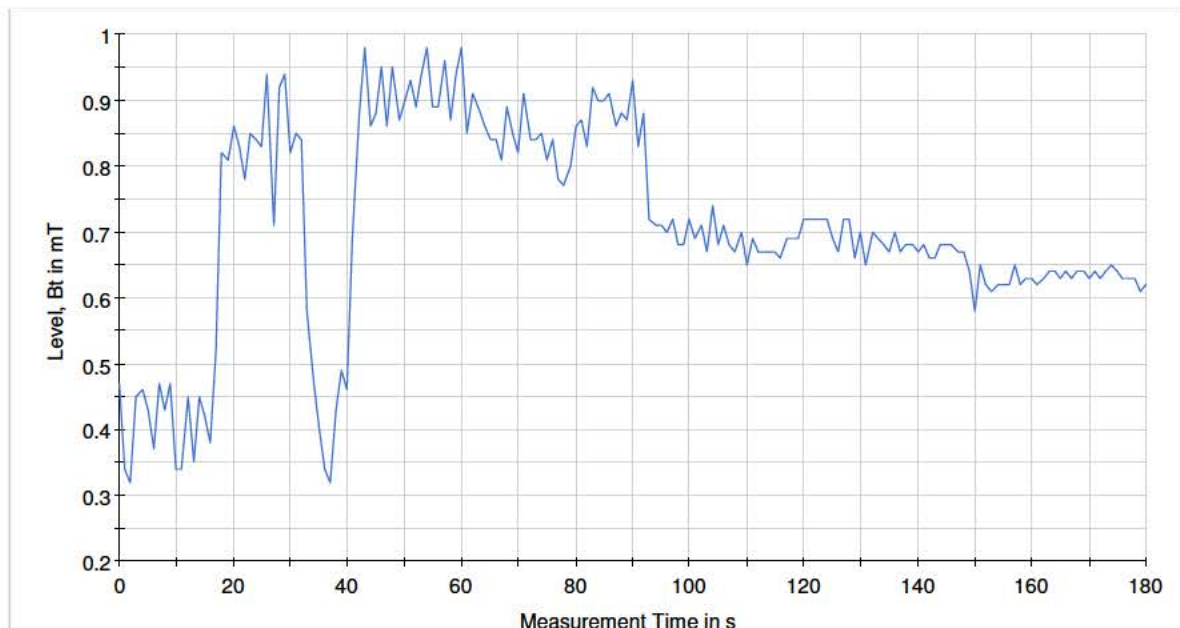

Transit-M5

A1.3 Stoptrain (acceleration), h=0 m., d=0.5 m.

Date & Time	Direction	Operating condition / Train type	Train serial #		Estimated current during test [A]		Distance to track [m]	Height - sensor [m]	Remark
			1	2	Min	Max			
2018/11/19 16:49	W => O	Stoptrain (accel) / Flirt	---	---	-409	915	0.5	0	P-1

Current data:

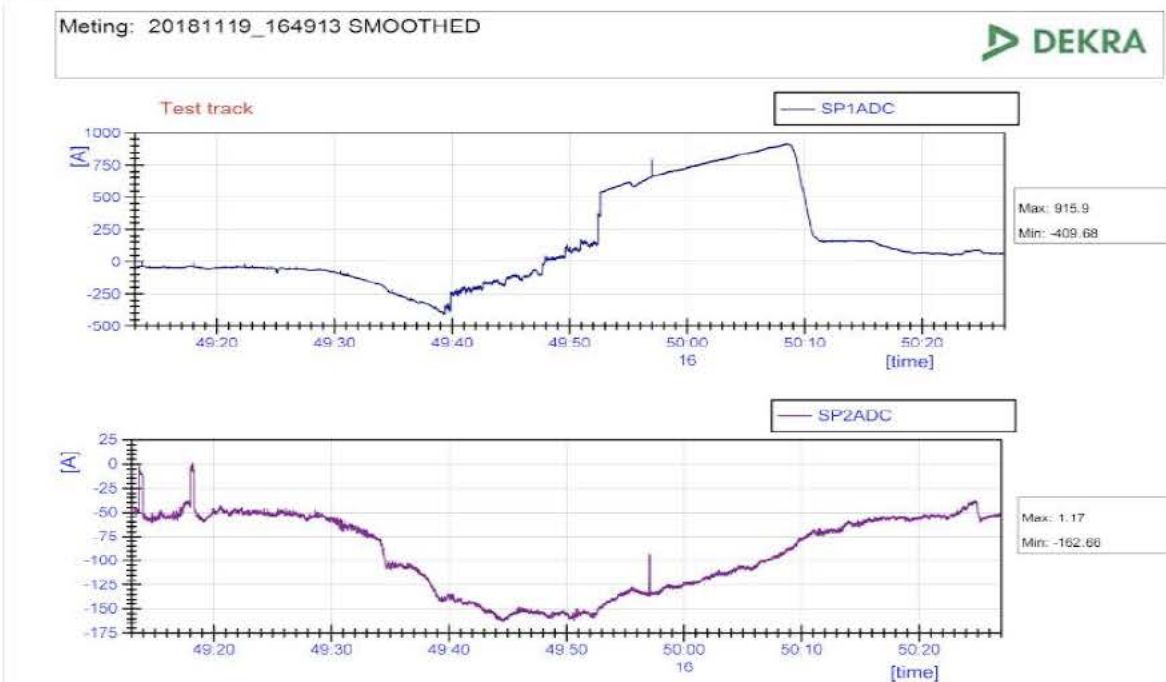

Measurement graphic:

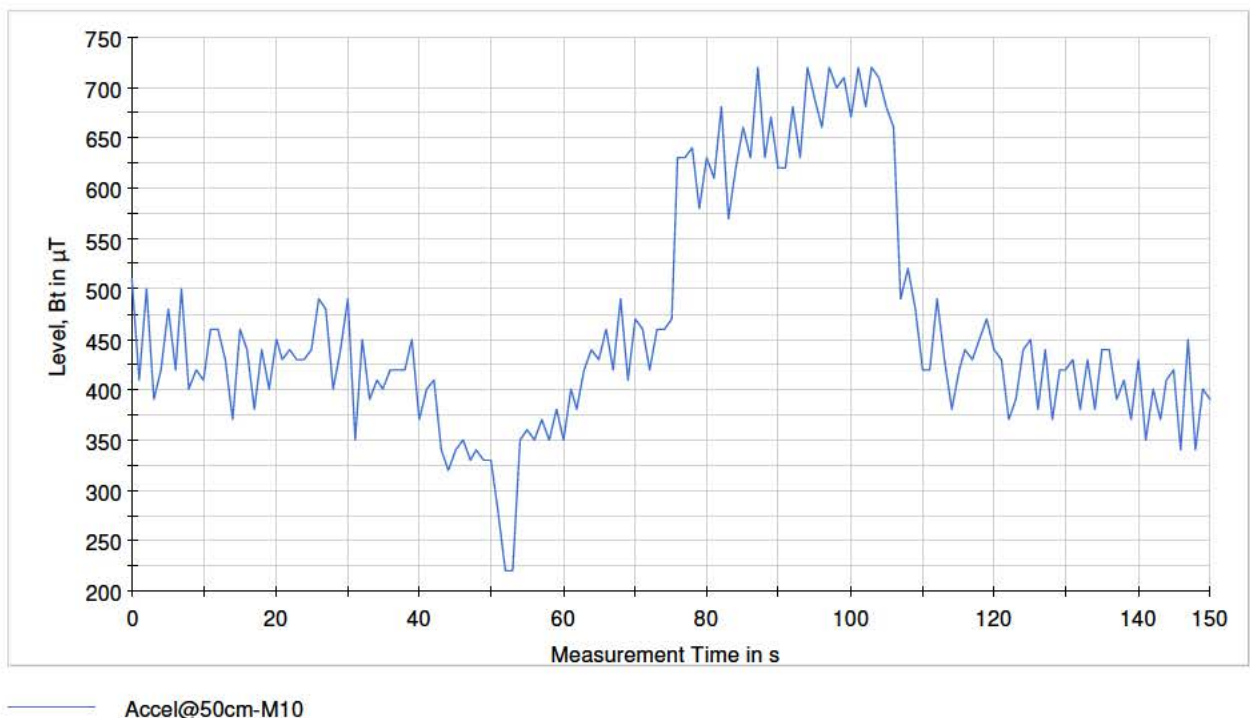

A1.4 Intercity-IC (transit), h=0 m., d=0.5 m.

Date & Time	Direction	Operating condition / Train type	Train serial #		Estimated current during test [A]		Distance to track [m]	Height - sensor [m]	Remark
			1	2	Min	Max			
2018/11/20 11:34	W => O	Intercity-IC (transit) / DDZ	7620	---	-289	291	0.5	0	P-1

Current data:

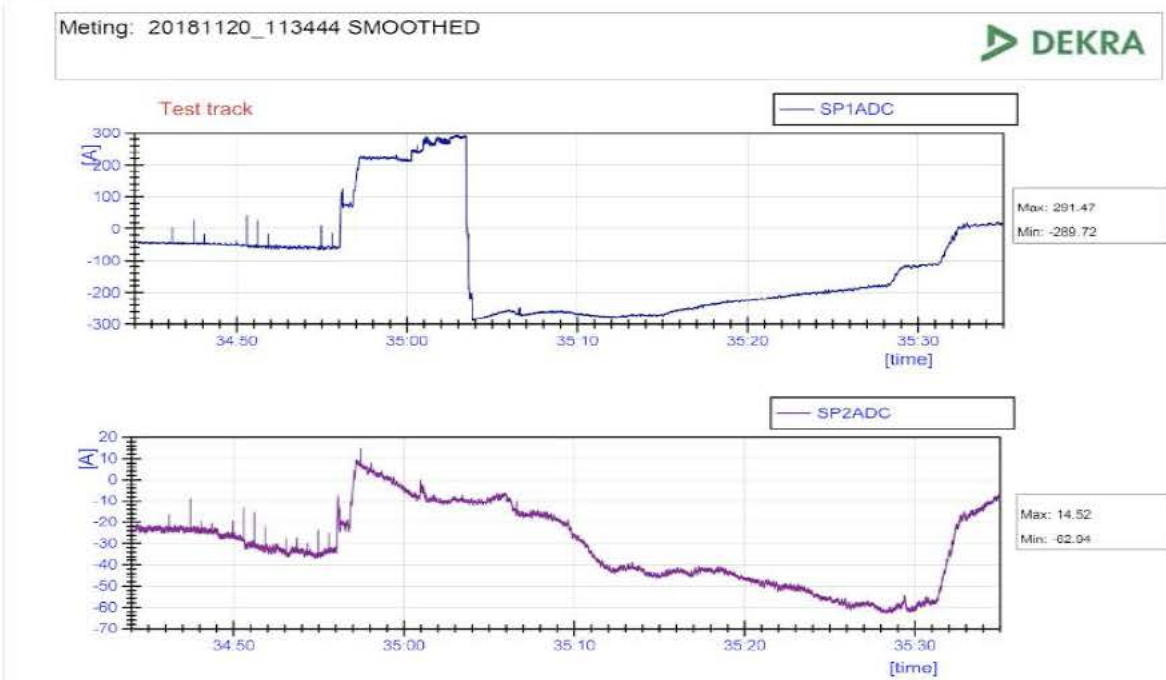

Measurement graphic:

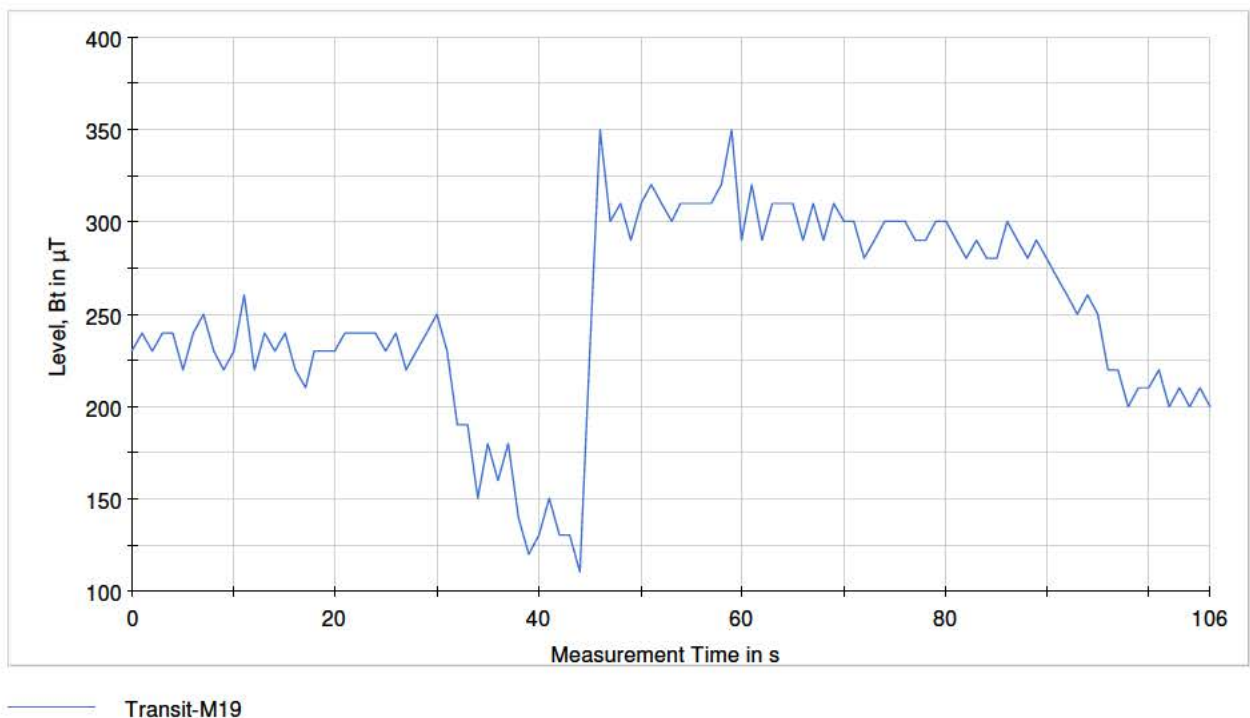

Date & Time	Direction	Operating condition / Train type	Train serial #		Estimated current during test [A]		Distance to track [m]	Height - sensor [m]	Remark
			1	2	Min	Max			
2018/11/19 13:36	W => O	Intercity-IC (transit) / DDZ	7614	---	-701	12	0.5	0	P-1

Current data:

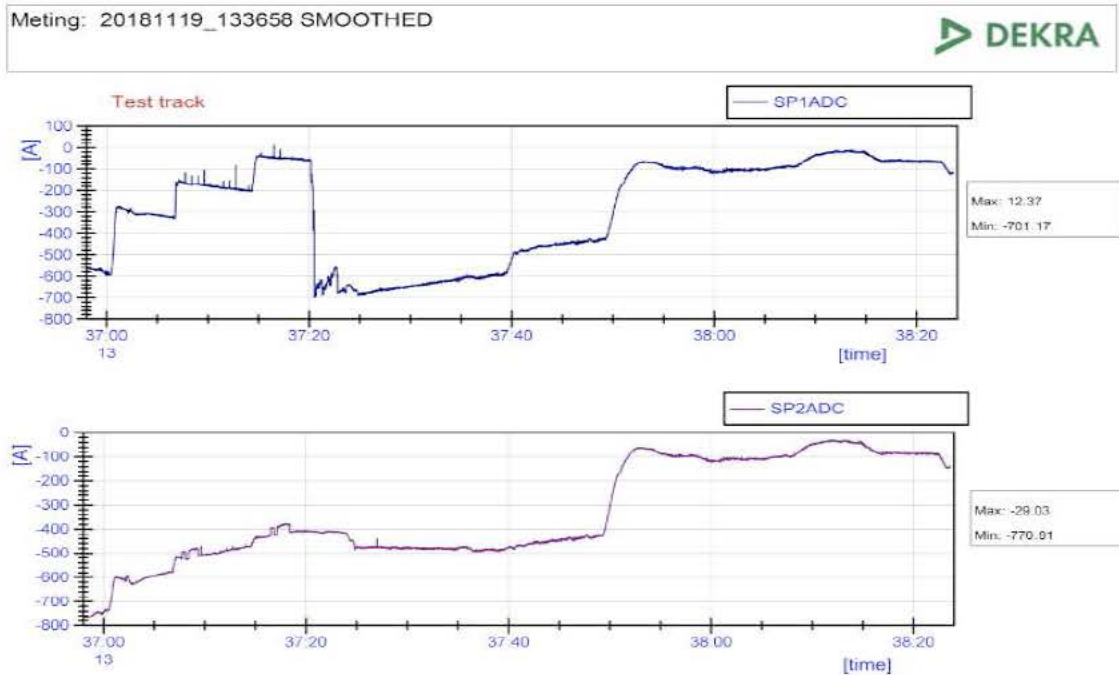

Measurement graphic:

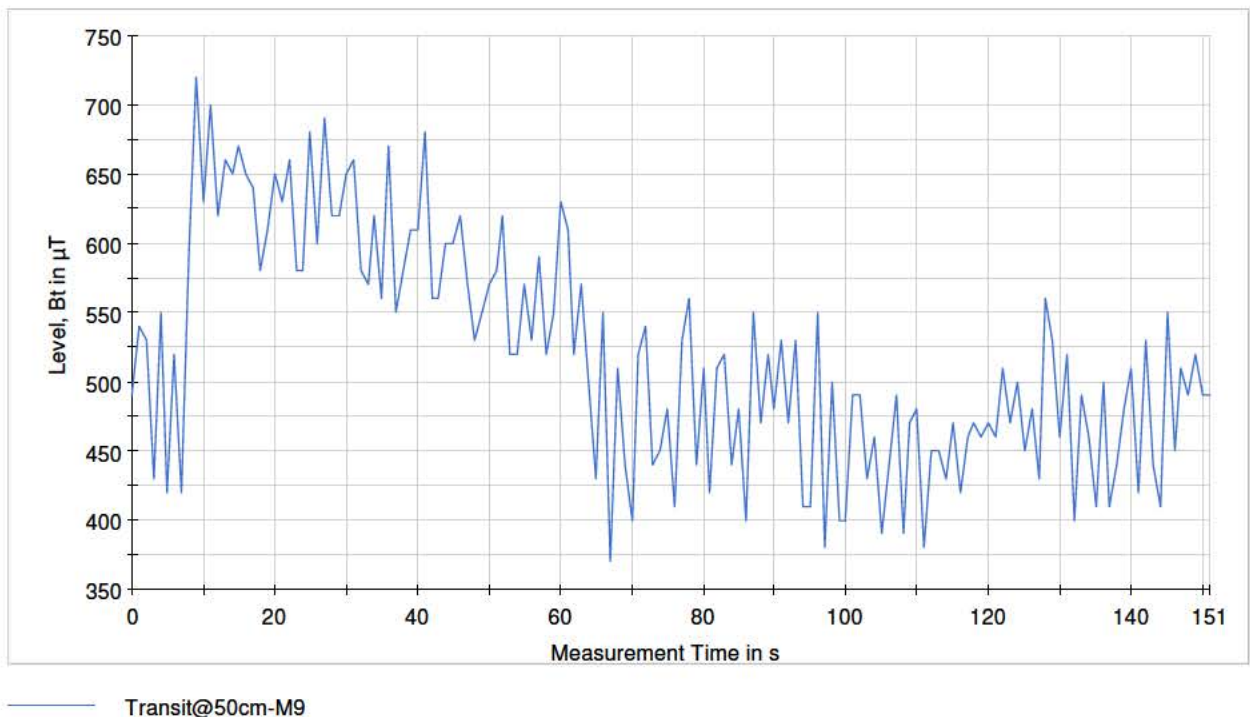

A1.5 Stoptrein (acceleration), h=0 m., d=1 m.

Date & Time	Direction	Operating condition / Train type	Train serial #		Estimated current during test [A]		Distance to track [m]	Height - sensor [m]	Remark
			1	2	Min	Max			
2018/11/20 10:18	W => O	Stoptrein (accel) / Flirt	2510	2209	-354	847	1	0	P-1

Current data:

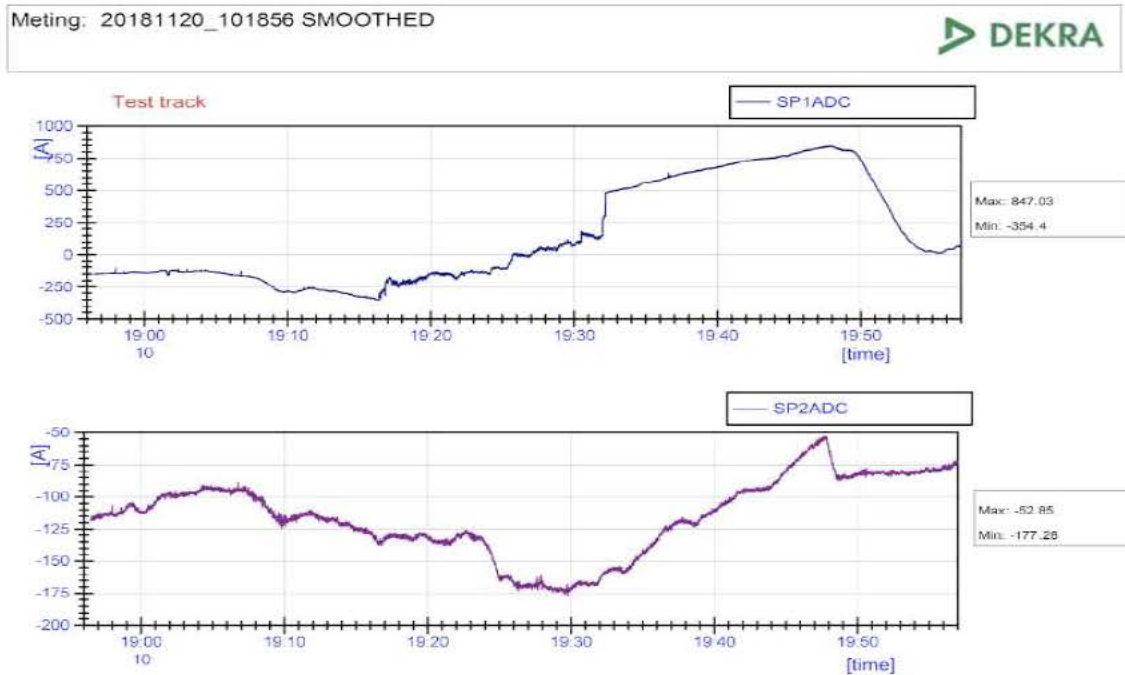

Measurement graphic:

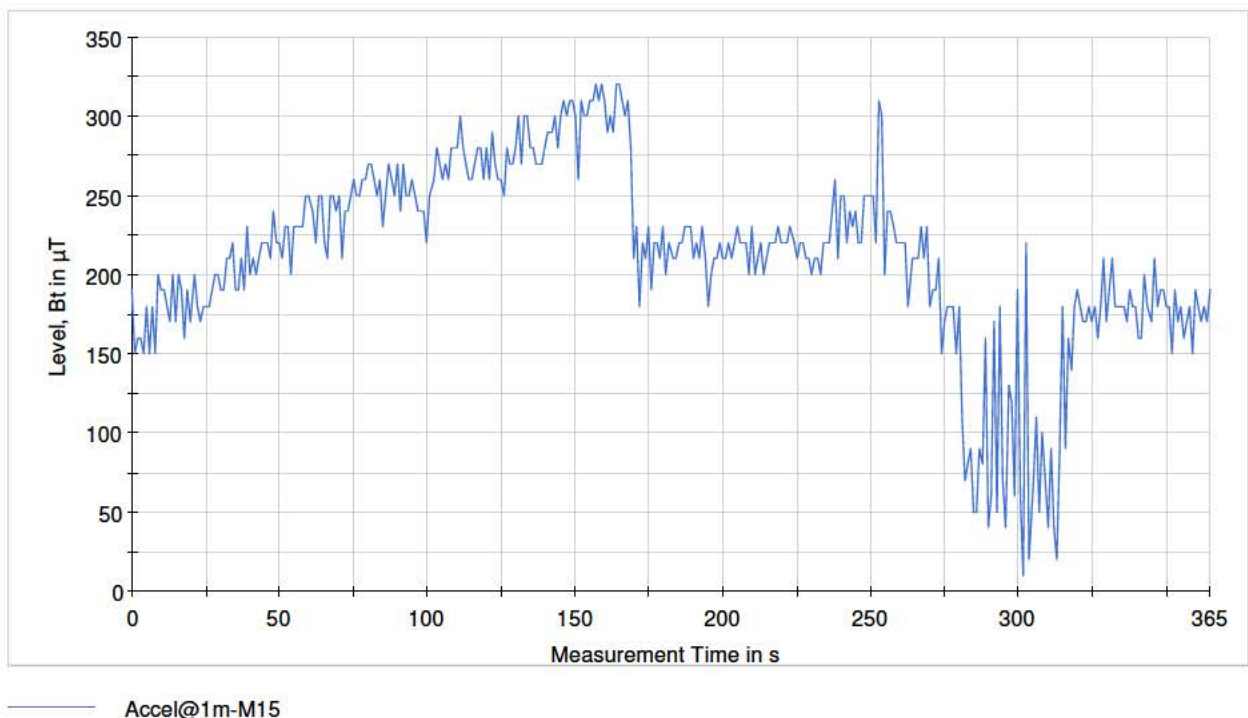

Date & Time	Direction	Operating condition / Train type	Train serial #		Estimated current during test [A]		Distance to track [m]	Height - sensor [m]	Remark
			1	2	Min	Max			
2018/11/20 10:48	W => O	Stoptrein (accel) / Flirt	2224	2212	-686	808	1	0	P-1

Current data:

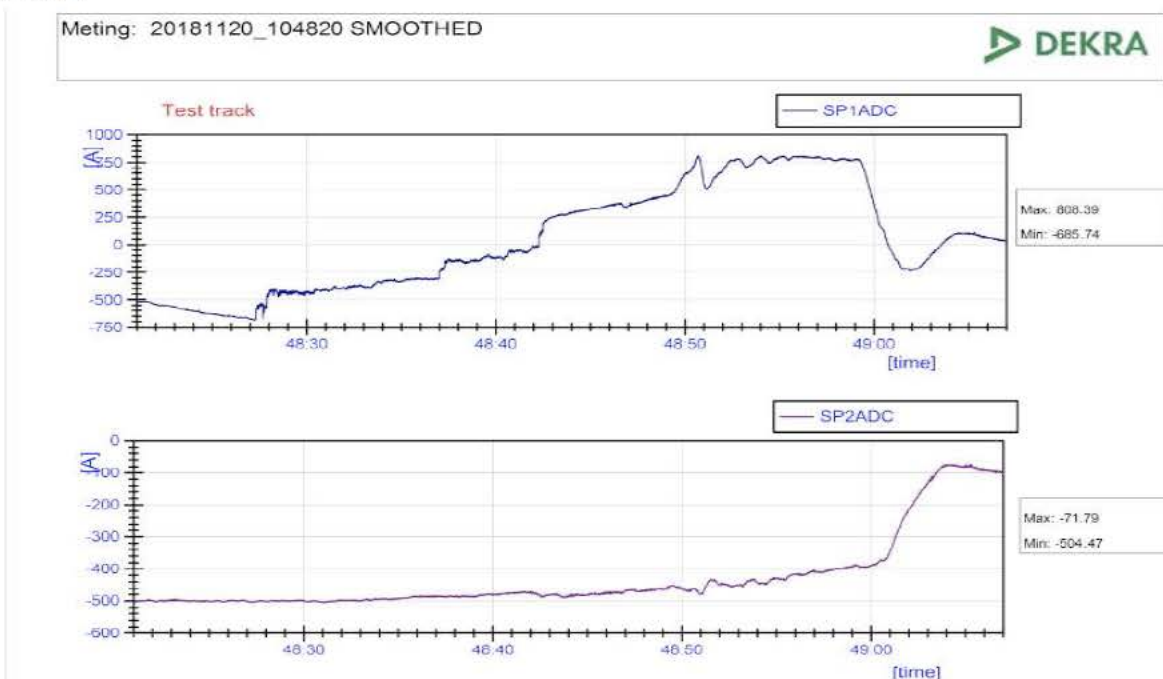

Measurement graphic:

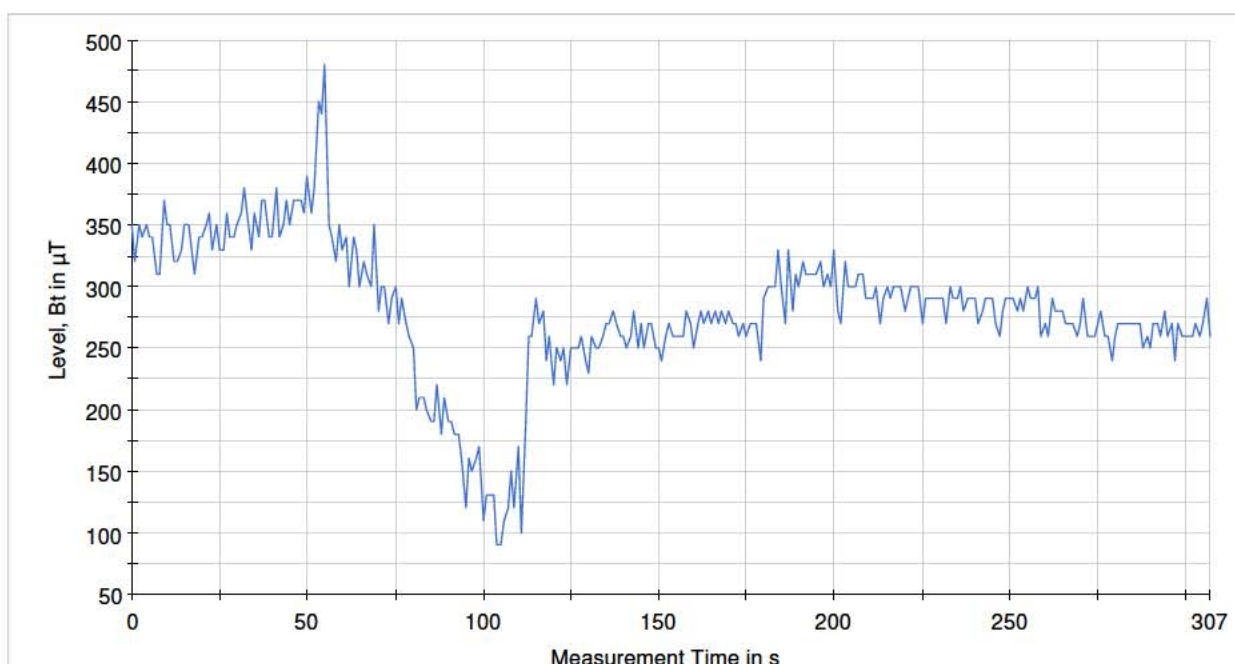

— Accel@1m-M16

Date & Time	Direction	Operating condition / Train type	Train serial #		Estimated current during test [A]		Distance to track [m]	Height - sensor [m]	Remark
			1	2	Min	Max			
2018/11/20 11:18	W => O	Stoptrein (accel) / Flirt	2517	2215	-1007	422	1	0	P-1

Current data:

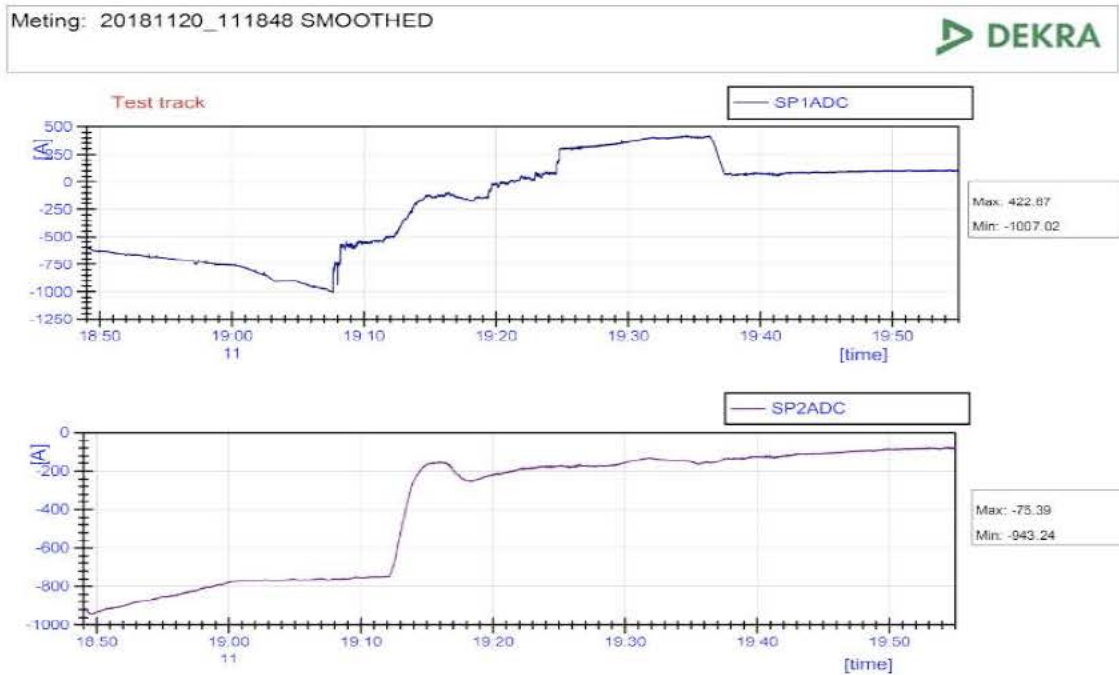

Measurement graphic:

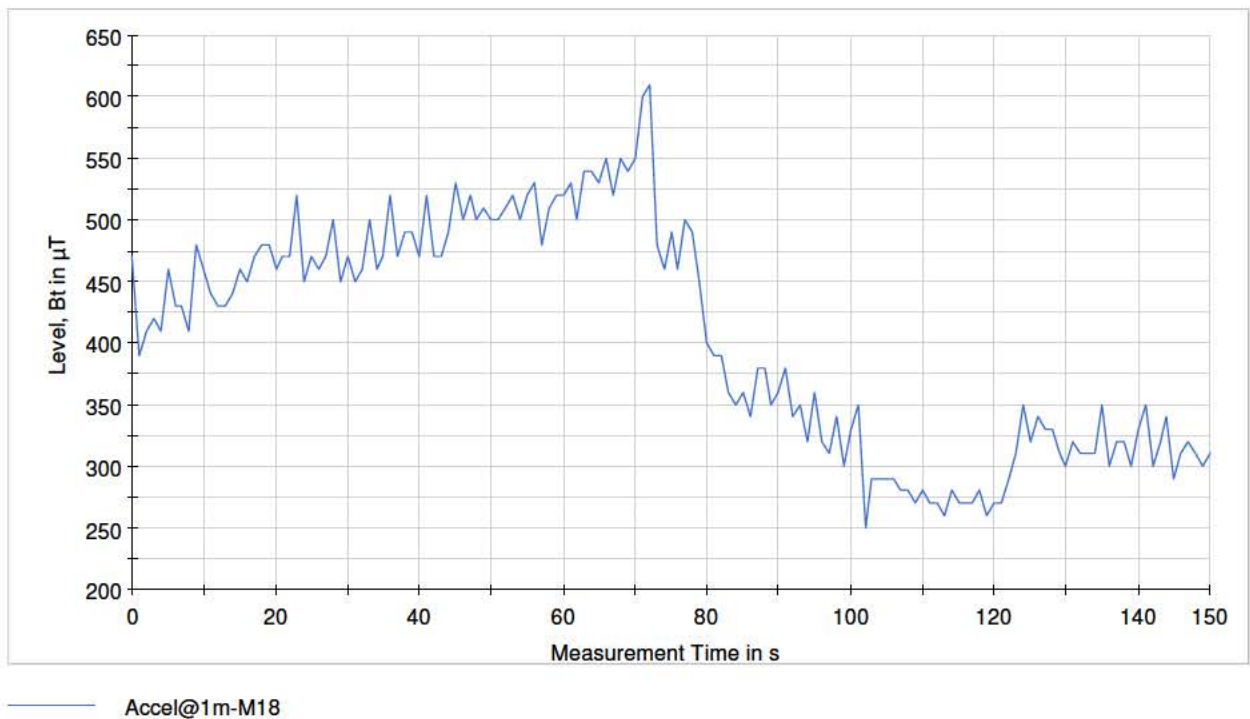

A1.6 Intercity-IC (transit), h=0 m., d=1 m.

Date & Time	Direction	Operating condition / Train type	Train serial #		Estimated current during test [A]		Distance to track [m]	Height - sensor [m]	Remark
			1	2	Min	Max			
2018/11/20 10:04	W => O	Intercity-IC (transit) / ICM	4030	---	-131	86	1	0	P-1

Current data:

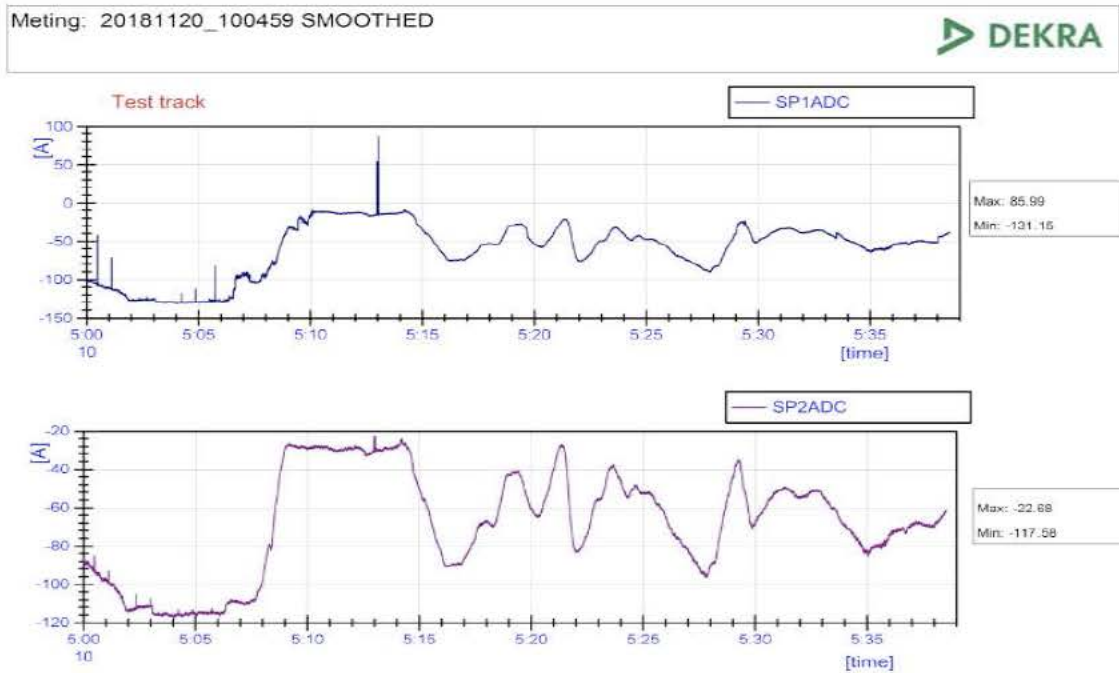

Measurement graphic:

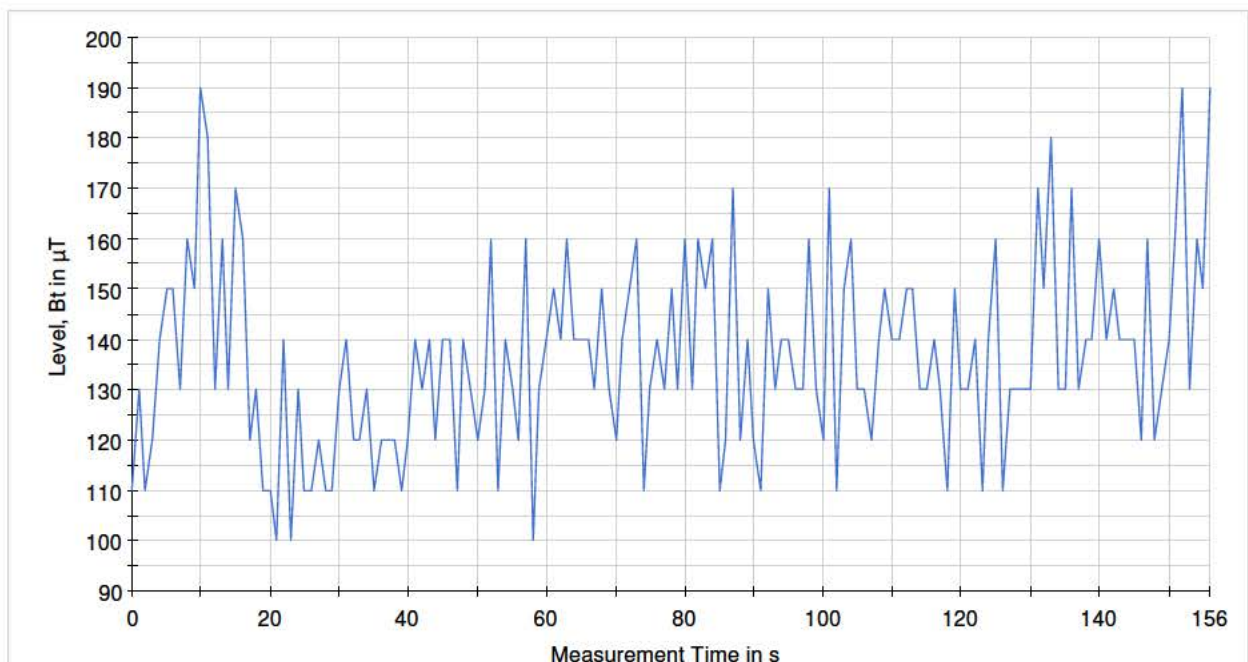

Transit@1m-M14

Date & Time	Direction	Operating condition / Train type	Train serial #		Estimated current during test [A]		Distance to track [m]	Height - sensor [m]	Remark
			1	2	Min	Max			
2018/11/20 11:05	W => O	Intercity-IC (transit) / DDZ	7616	---	-204	105	1	0	P-1

Current data:



Measurement graphic:

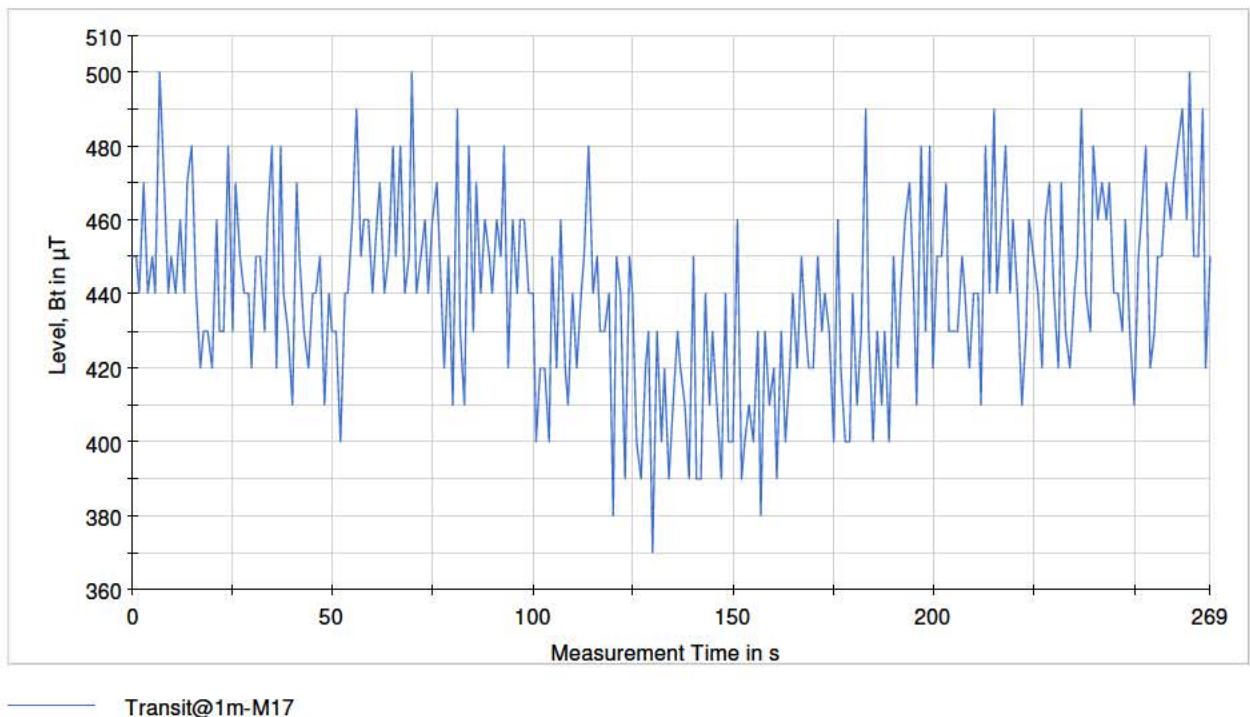

A1.7 Stoptrein (acceleration), h=0.3 m., d=1.25 m.

Date & Time	Direction	Operating condition / Train type	Train serial #		Estimated current during test [A]		Distance to track [m]	Height - sensor [m]	Remark
			1	2	Min	Max			
2018/11/19 09:17	W => O	Stoptrein (accel) / Flirt	2219	2504	-269	925	1.25	0.3	P-2, Bz-axis

Current data:

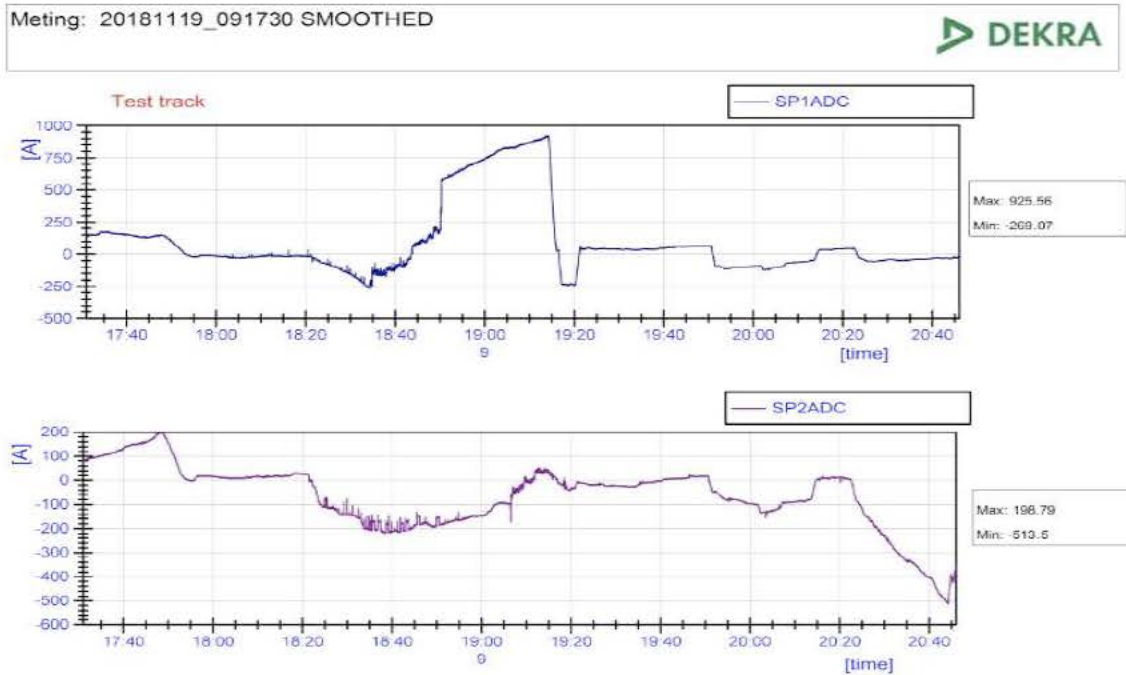

Measurement graphic:

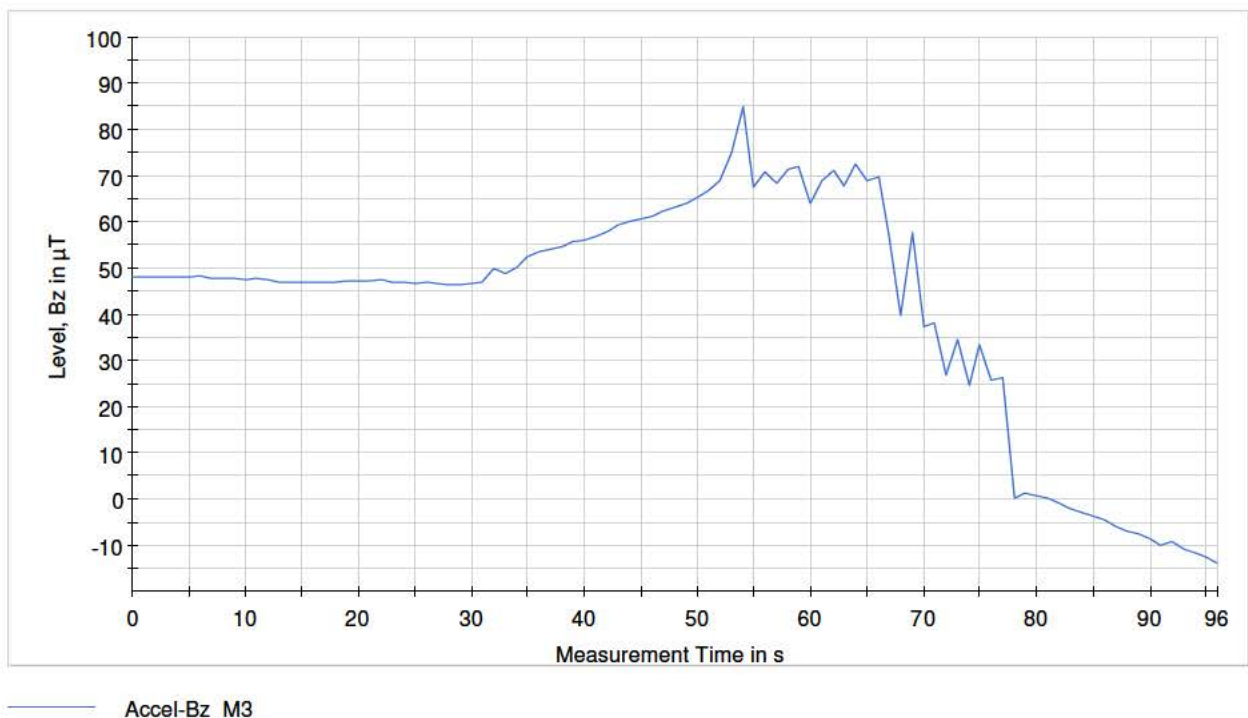

Date & Time	Direction	Operating condition / Train type	Train serial #		Estimated current during test [A]		Distance to track [m]	Height - sensor [m]	Remark
			1	2	Min	Max			
2018/11/19 12:19	W => O	Stoptrein (accel) / Flirt	2507	2211	-319	667	1.25	0.3	P-2, Bz-axis

Current data:

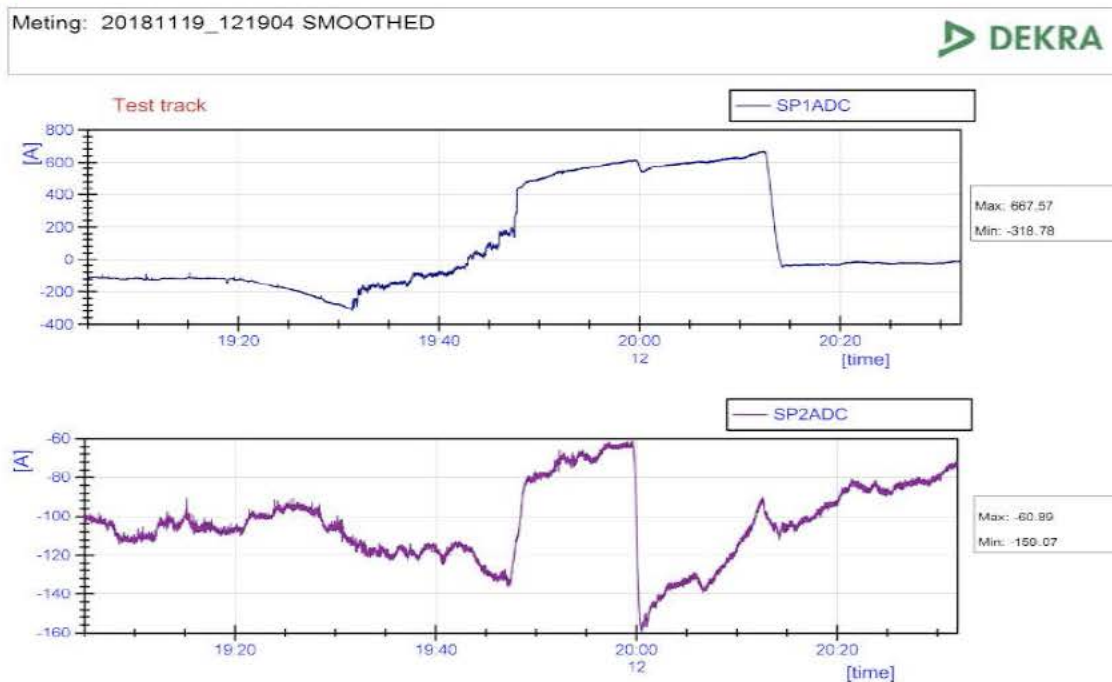

Measurement graphic:

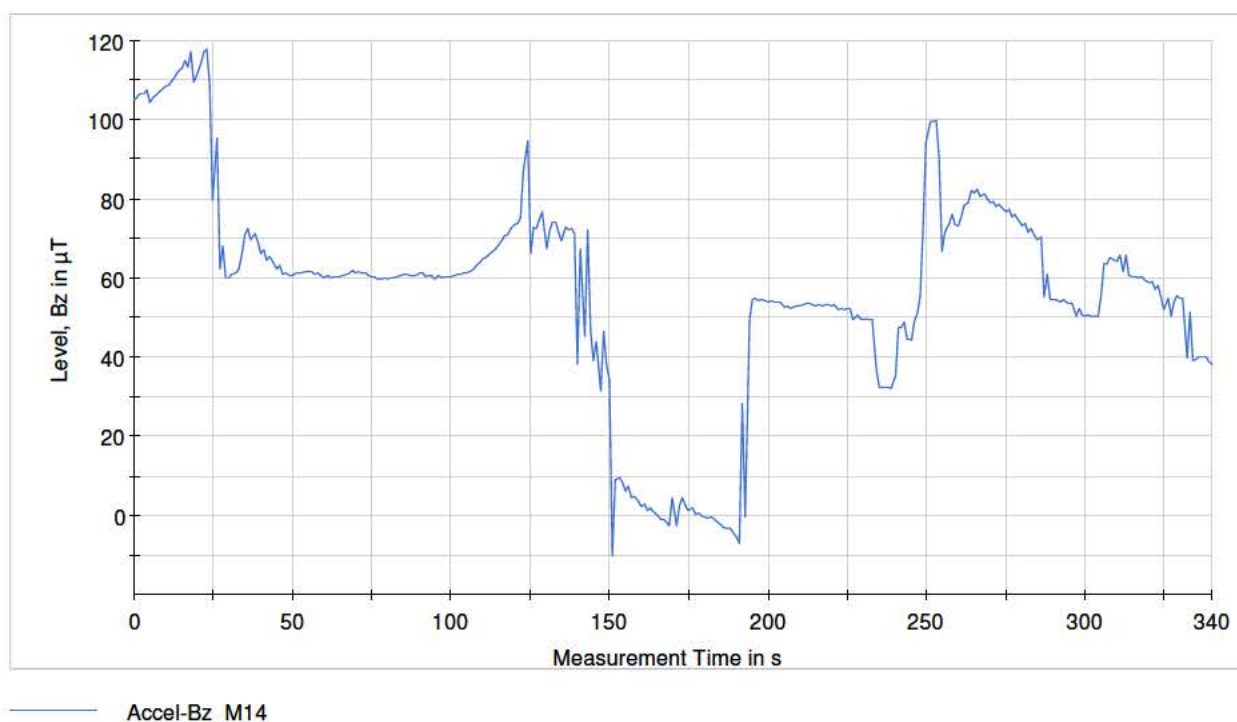

Date & Time	Direction	Operating condition / Train type	Train serial #		Estimated current during test [A]		Distance to track [m]	Height - sensor [m]	Remark
			1	2	Min	Max			
2018/11/19 13:48	W => O	Stoptrein (accel) / Flirt	2524	2228	-637	363	1.25	0.3	P-2, Bx-axis

Current data:

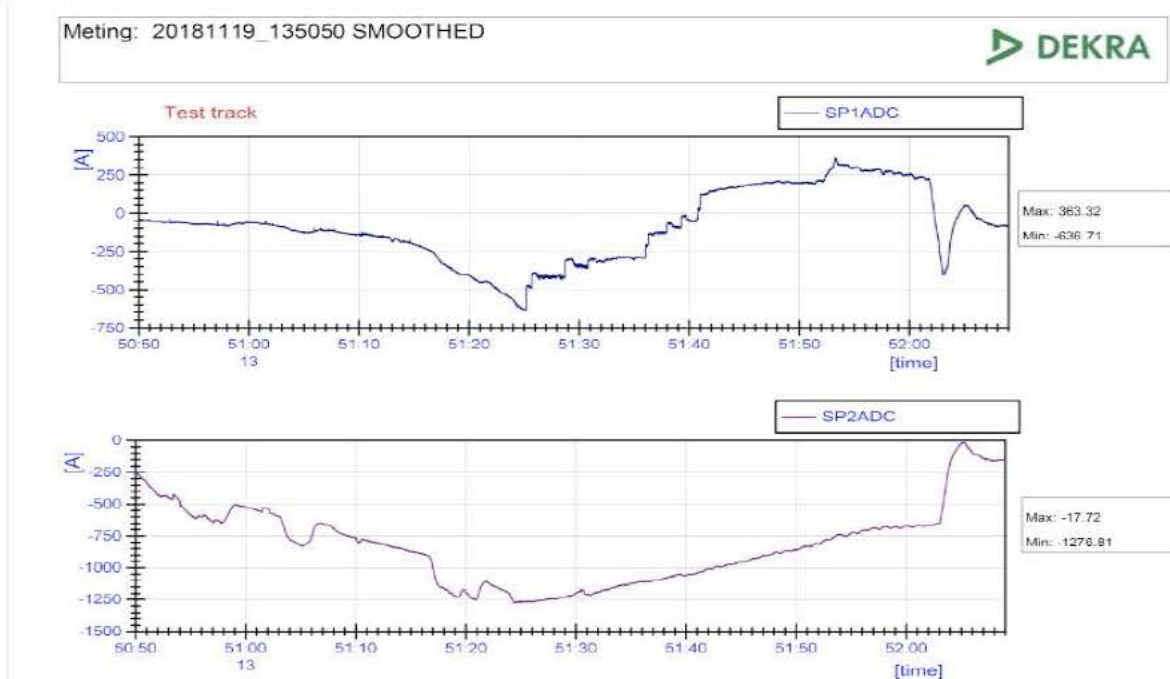

Measurement graphic:

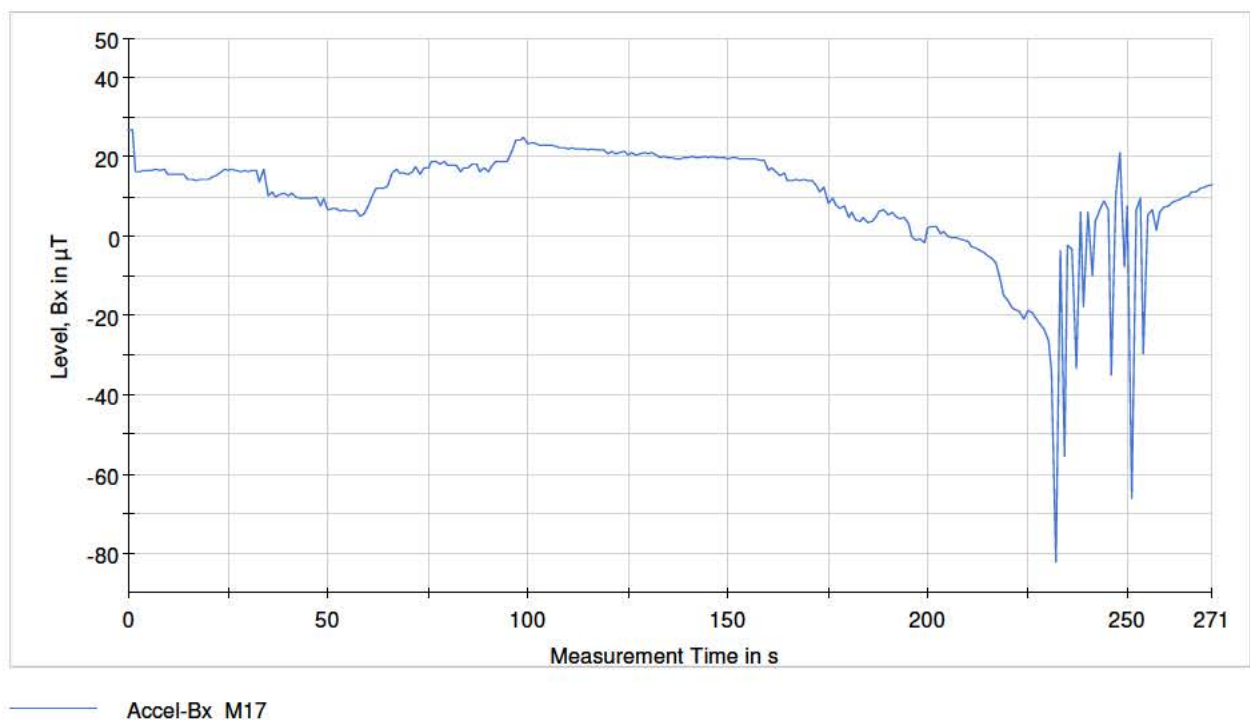

Date & Time	Direction	Operating condition / Train type	Train serial #		Estimated current during test [A]		Distance to track [m]	Height - sensor [m]	Remark
			1	2	Min	Max			
2018/11/19 14:48	W => O	Stoptrein (accel) / Flirt	2209	2510	-404	1142	1.25	0.3	P-2, Bx-axis

Current data:

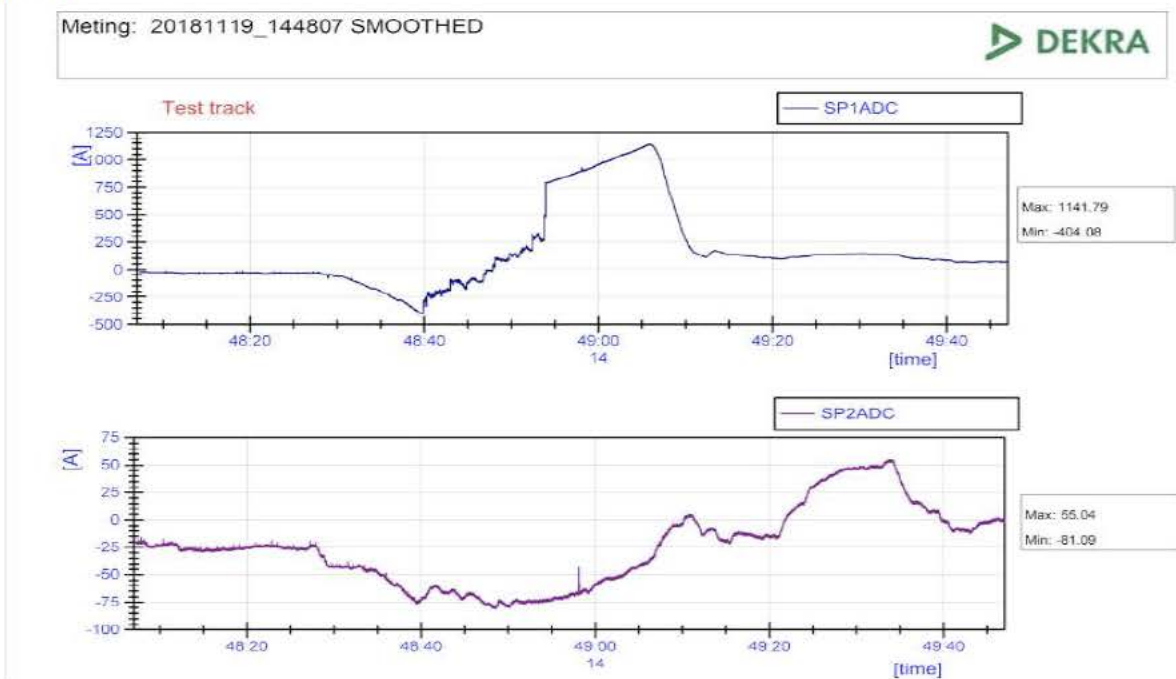

Measurement graphic:

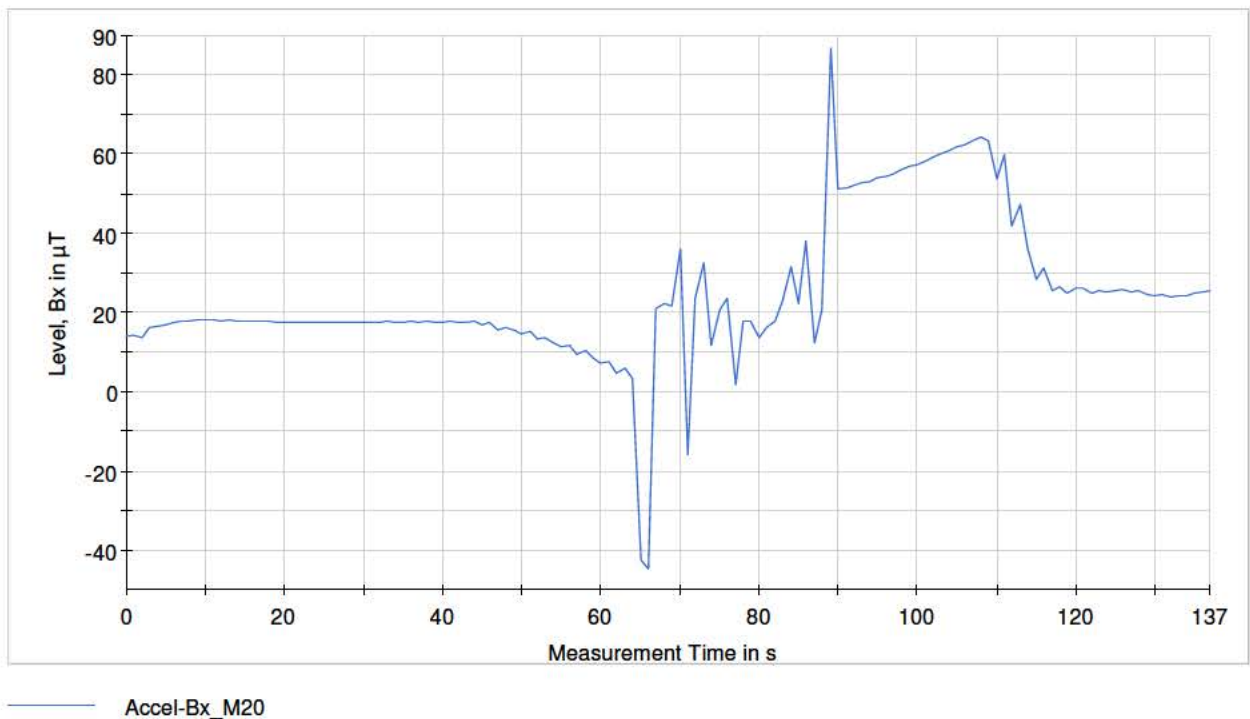

Date & Time	Direction	Operating condition / Train type	Train serial #		Estimated current during test [A]		Distance to track [m]	Height - sensor [m]	Remark
			1	2	Min	Max			
2018/11/19 11:17	W => O	Stoptrein (accel) / Flirt	2508	2223	-890	739	1.25	0.3	P-2, By-axis

Current data:

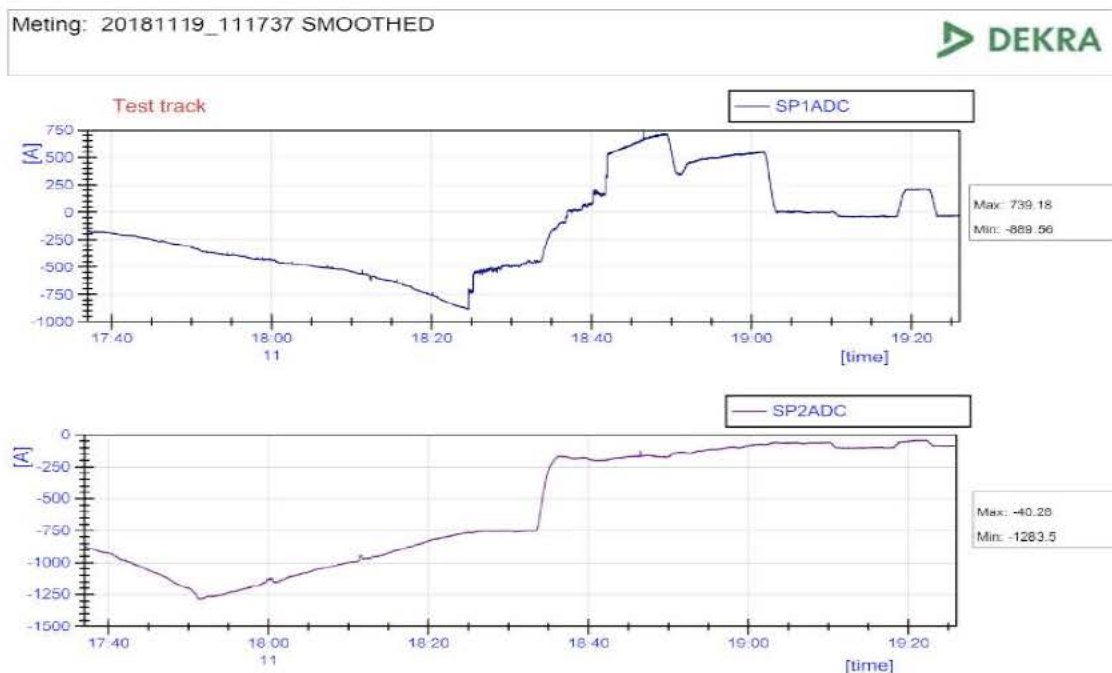

Measurement graphic:

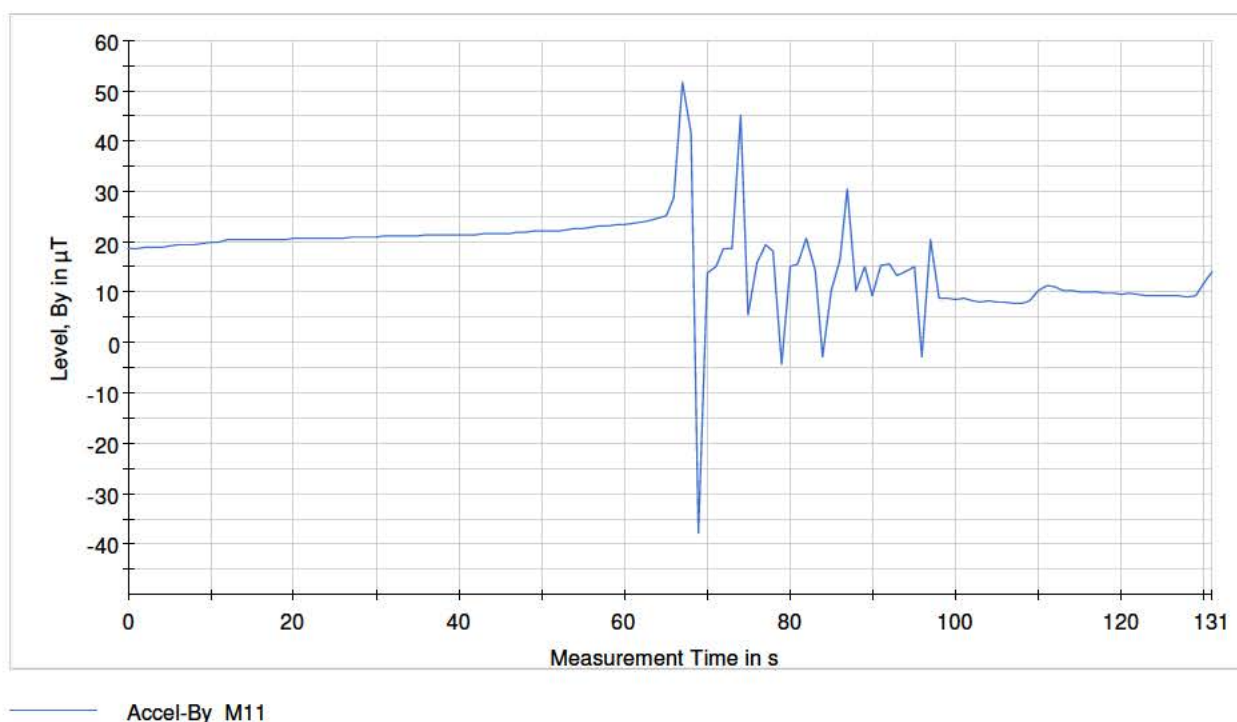

A1.8 Intercity-IC (transit), h=0.3 m., d=1.25 m.

Date & Time	Direction	Operating condition / Train type	Train serial #		Estimated current during test [A]		Distance to track [m]	Height - sensor [m]	Remark
			1	2	Min	Max			
2018/11/19 09:28	W => O	Intercity-IC (transit) / ICM	4049	4224	-234	165	1.25	0.3	P-2, Bz-axis

Current data:

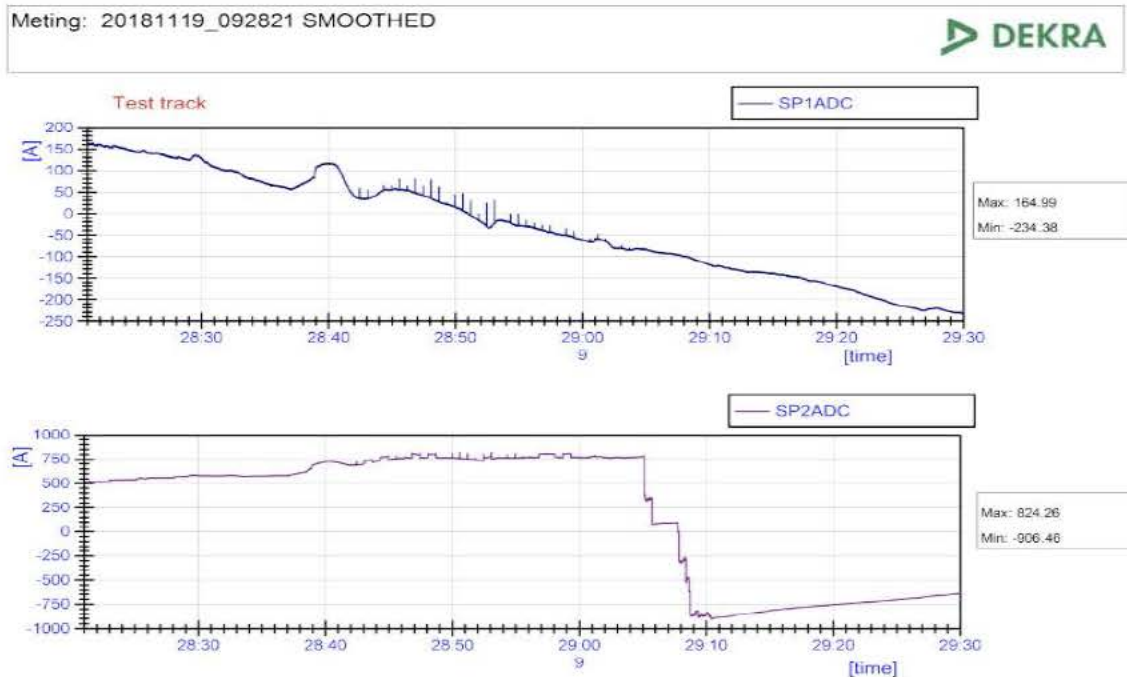

Measurement graphic:

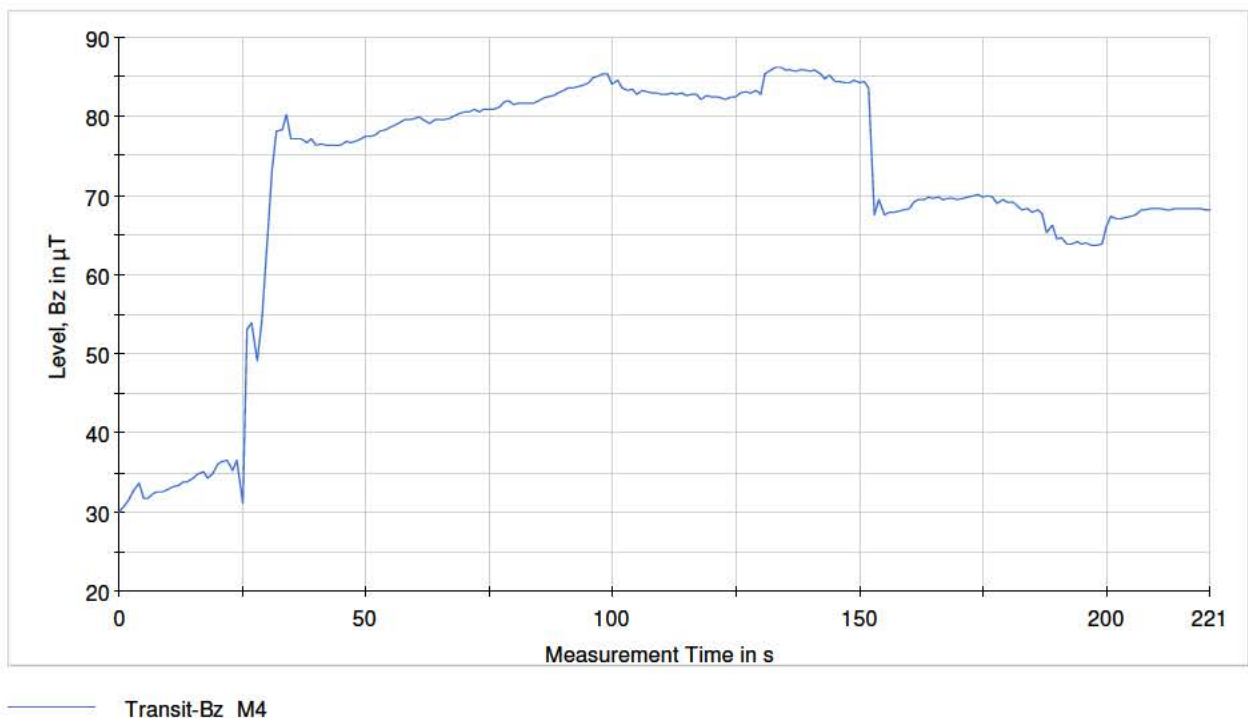

Date & Time	Direction	Operating condition / Train type	Train serial #		Estimated current during test [A]		Distance to track [m]	Height - sensor [m]	Remark
			1	2	Min	Max			
2018/11/19 10:05	W => O	Intercity-IC (transit) / ICM	4060	4247	-309	50	1.25	0.3	P-2, By-axis

Current data:



Measurement graphic:

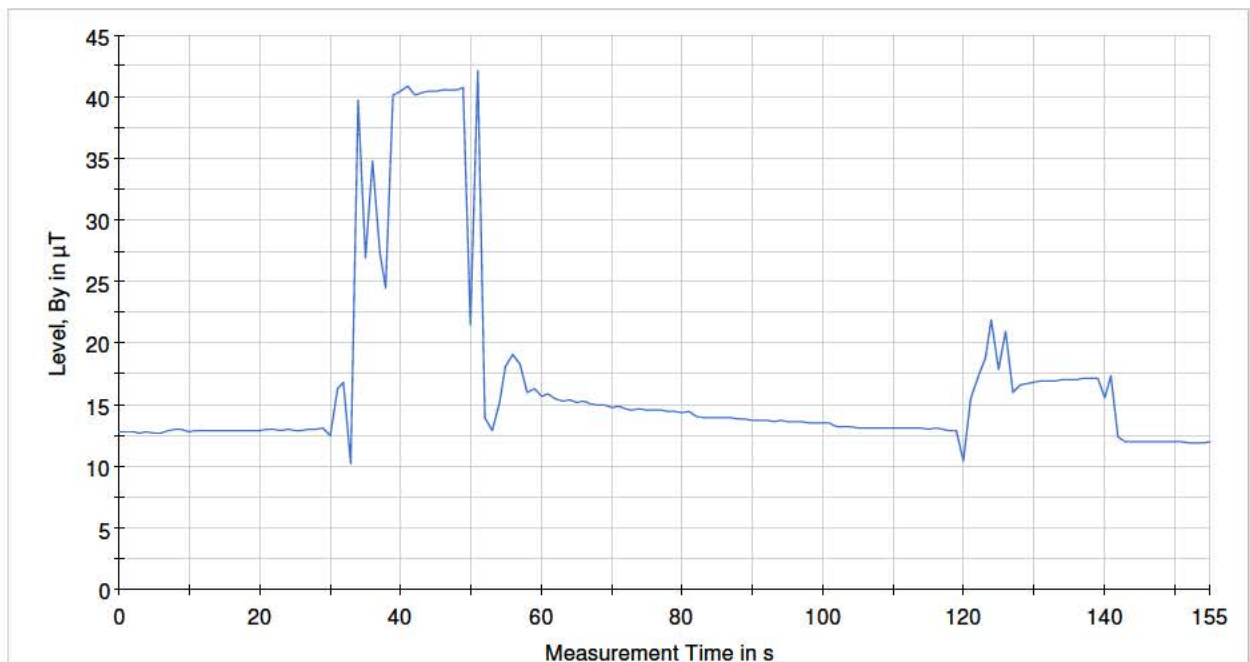

— Transit-By_M8

Date & Time	Direction	Operating condition / Train type	Train serial #		Estimated current during test [A]		Distance to track [m]	Height - sensor [m]	Remark
			1	2	Min	Max			
2018/11/19 13:30	W => O	Intercity-IC (transit) / DDZ	7614	---	-701	12	1.25	0.3	P-2, Bx-axis

Current data:

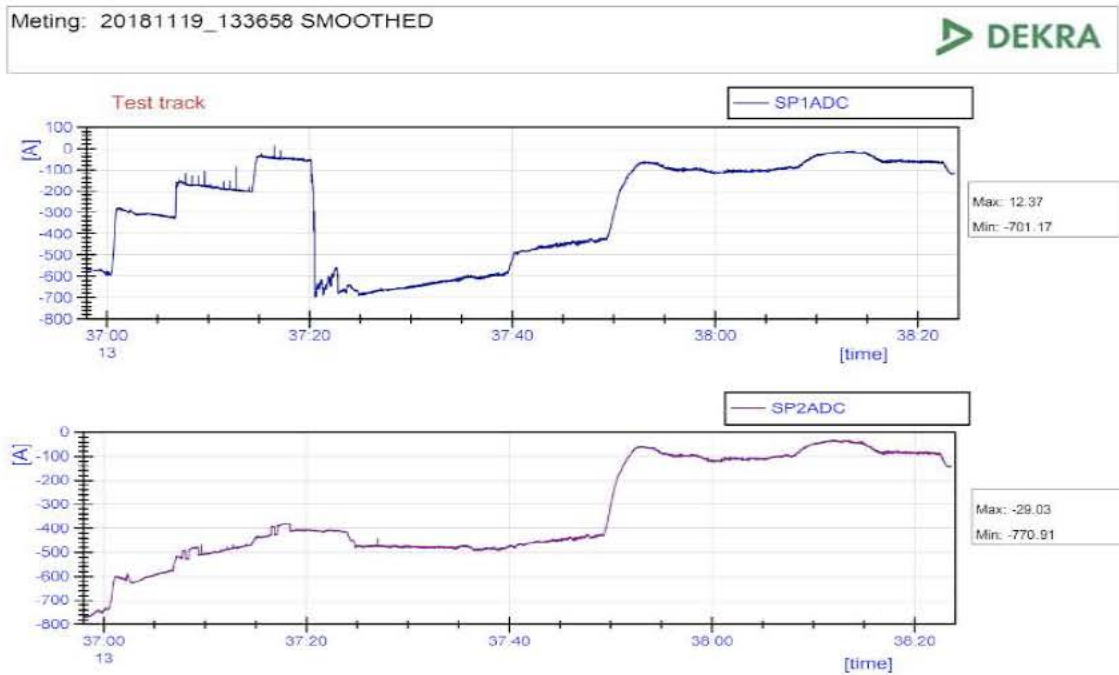

Measurement graphic:

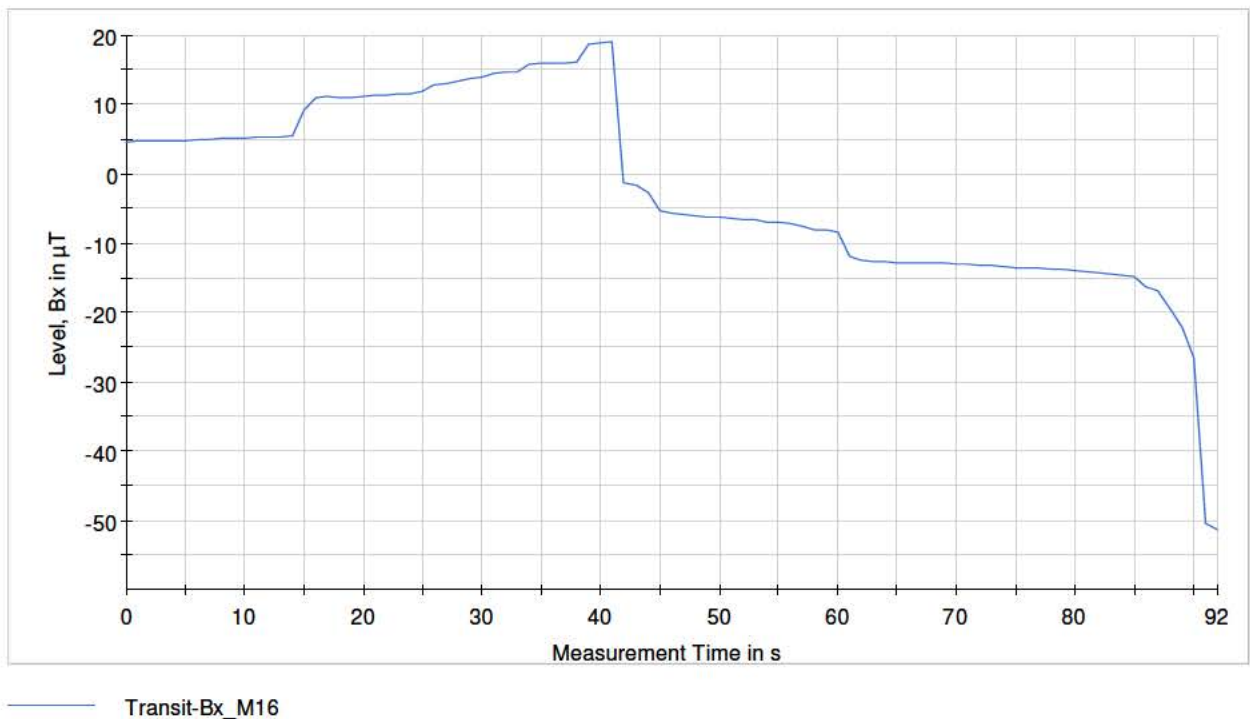

Date & Time	Direction	Operating condition / Train type	Train serial #		Estimated current during test [A]		Distance to track [m]	Height - sensor [m]	Remark
			1	2	Min	Max			
2018/11/19 14:33	W => O	Intercity-IC (transit) / DDZ	7650	---	-306	216	1.25	0.3	P-2, Bx-axis

Current data:

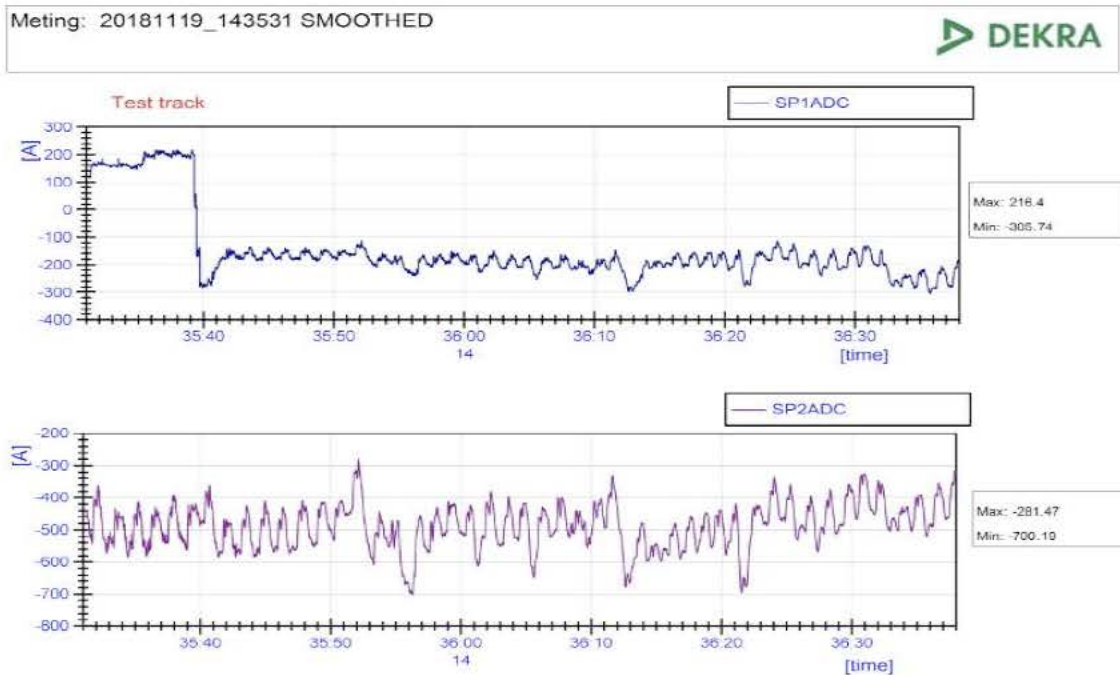

Measurement graphic:

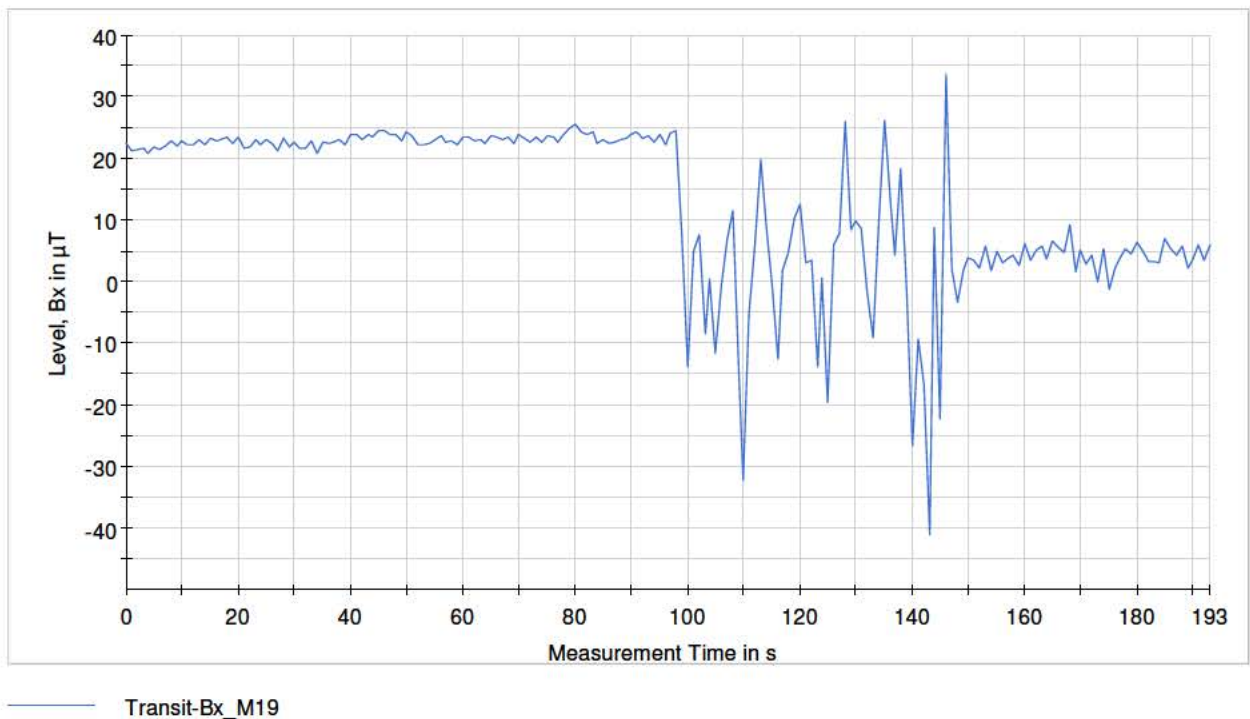

A1.9 Braking (@SP2ADC), h=0.3 m., d=1.25 m.

Date & Time	Direction	Operating condition / Train type	Train serial #		Estimated current during test [A]		Distance to track [m]	Height - sensor [m]	Remark
			1	2	Min	Max			
2018/11/19 09:50	O => W	Braking (@SP2ADC) / VIRM	9548	---	-175	110	1.25	0.3	P-2, By-axis

Current data:

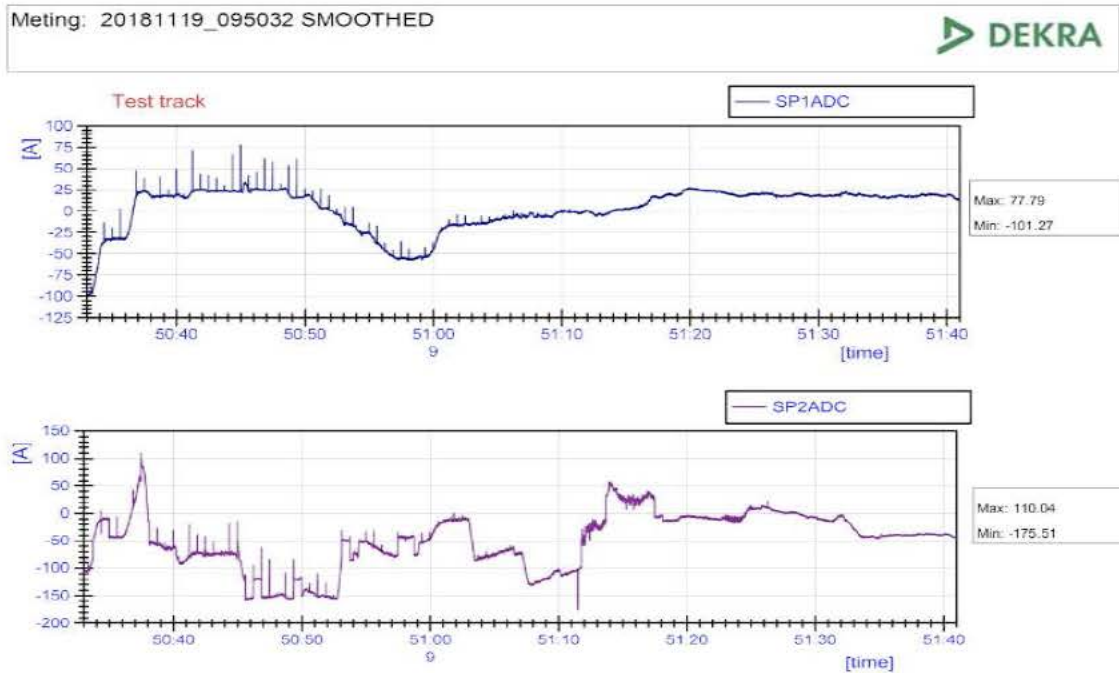

Measurement graphic:

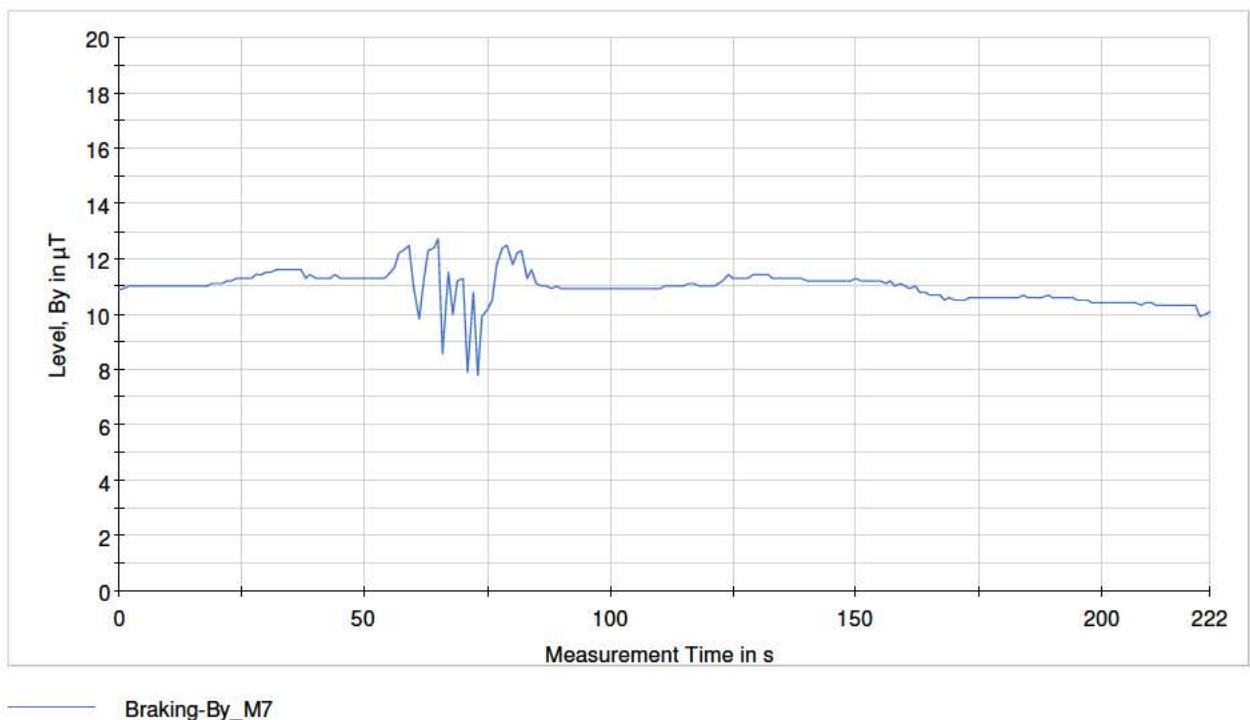

A1.10 Stoptrein (acceleration), h=0.7 m., d=1.25 m.

Date & Time	Direction	Operating condition / Train type	Train serial #		Estimated current during test [A]		Distance to track [m]	Height - sensor [m]	Remark
			1	2	Min	Max			
2018/11/19 16:59	W => O	Stoptrein (accel) / Flirt	---	---	-389	394	1.25	0.7	P-2, Bz-axis

Current data:

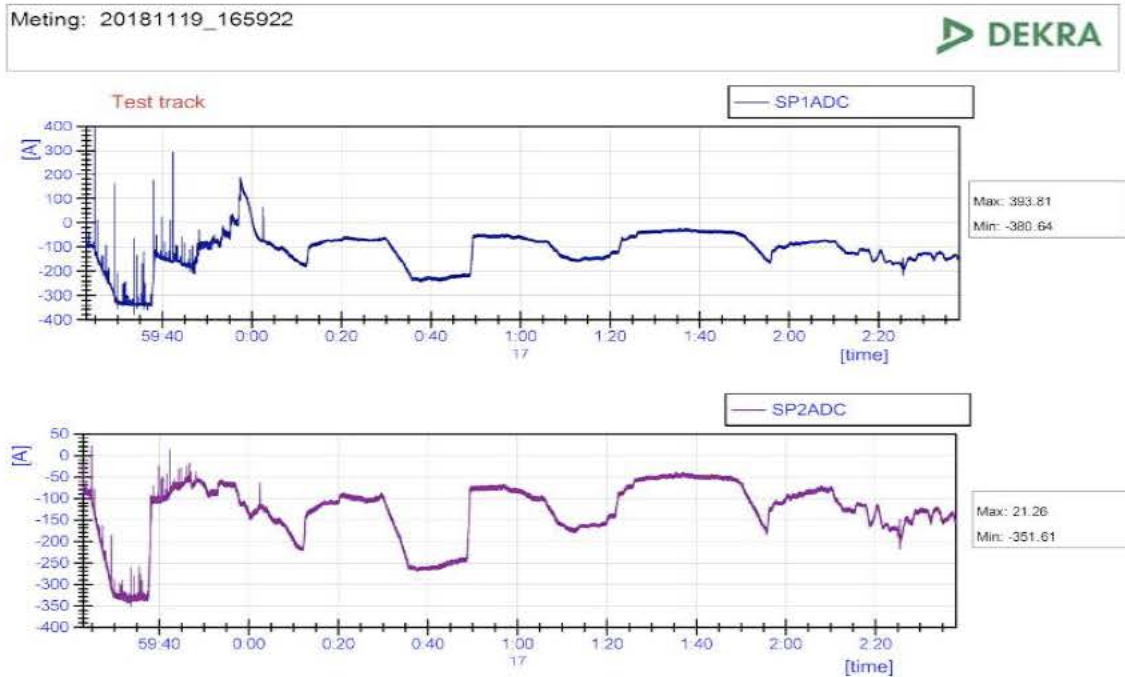

Measurement graphic:

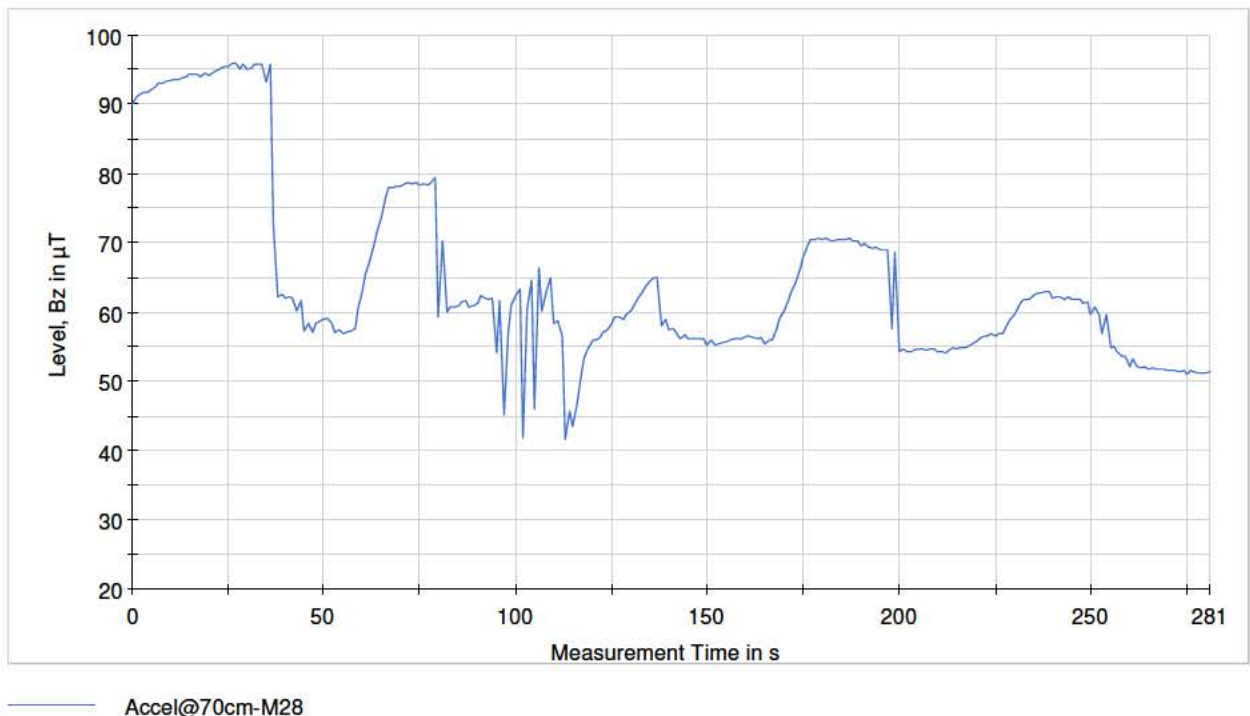

Date & Time	Direction	Operating condition / Train type	Train serial #		Estimated current during test [A]		Distance to track [m]	Height - sensor [m]	Remark
			1	2	Min	Max			
2018/11/20 15:18	W => O	Stoptrein (accel) / Flirt	2209	2510	-463	557	1.25	0.7	P-2, Bz-axis

Current data:

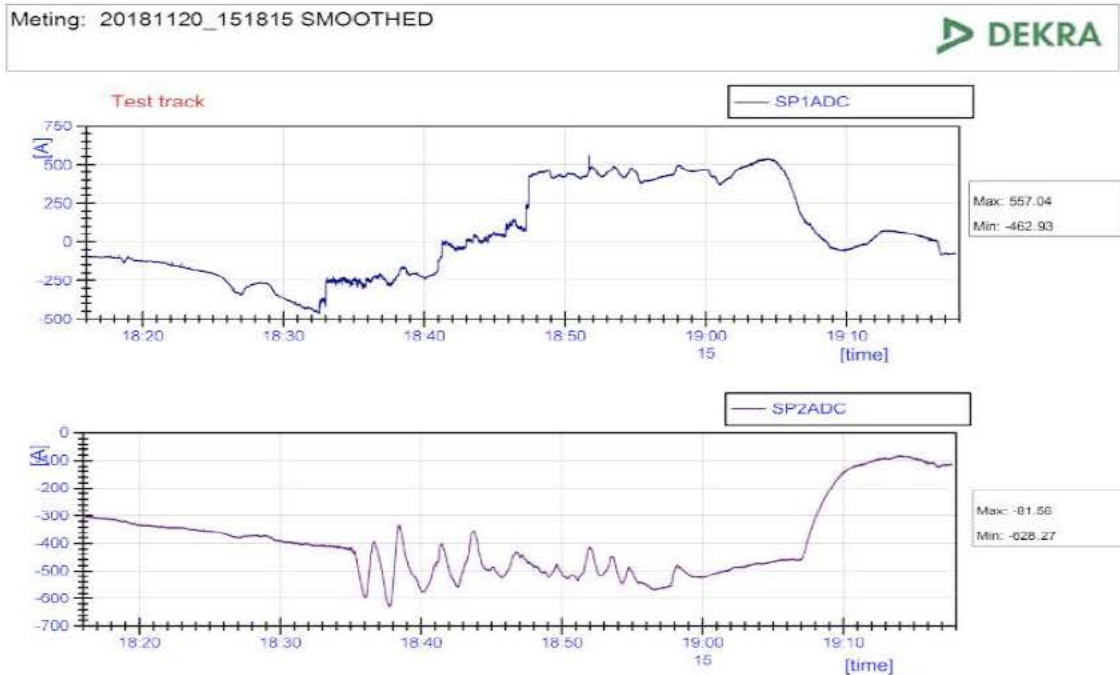

Measurement graphic:

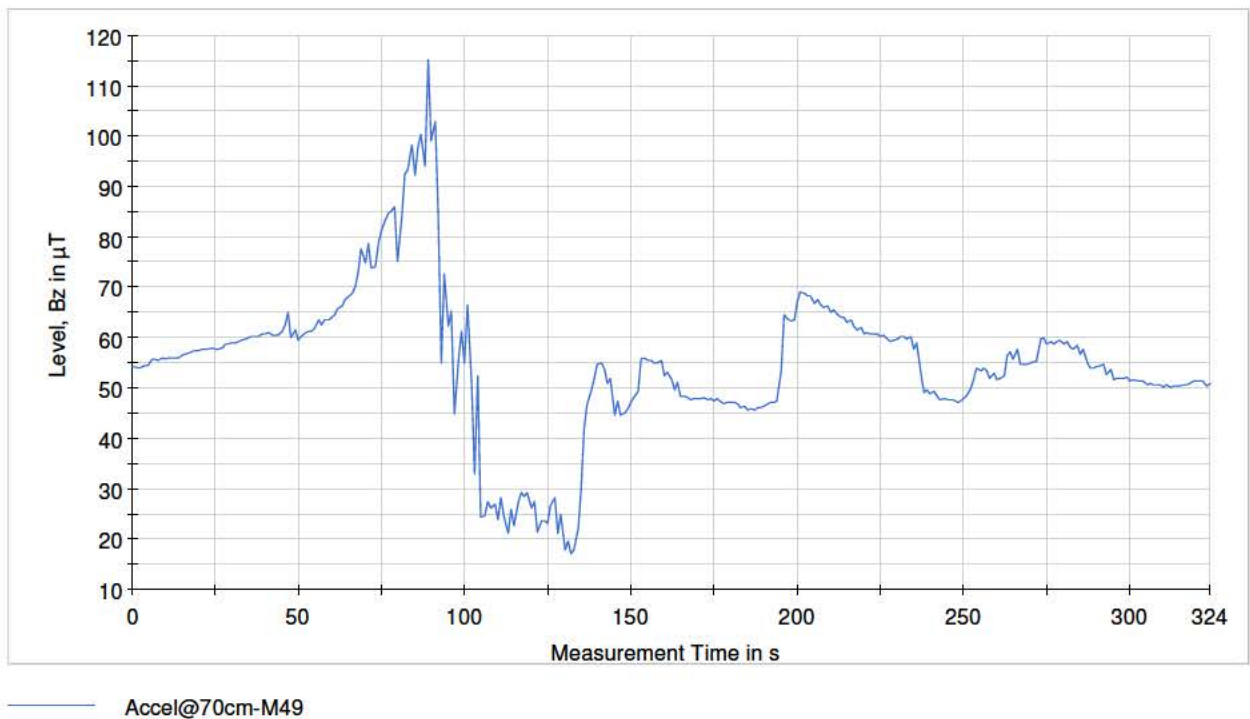

Date & Time	Direction	Operating condition / Train type	Train serial #		Estimated current during test [A]		Distance to track [m]	Height - sensor [m]	Remark
			1	2	Min	Max			
2018/11/20 09:49	W => O	Stoptrein (accel) / Flirt	2219	2504	-473	960	1.25	0.7	P-2, Bz-axis

Current data:

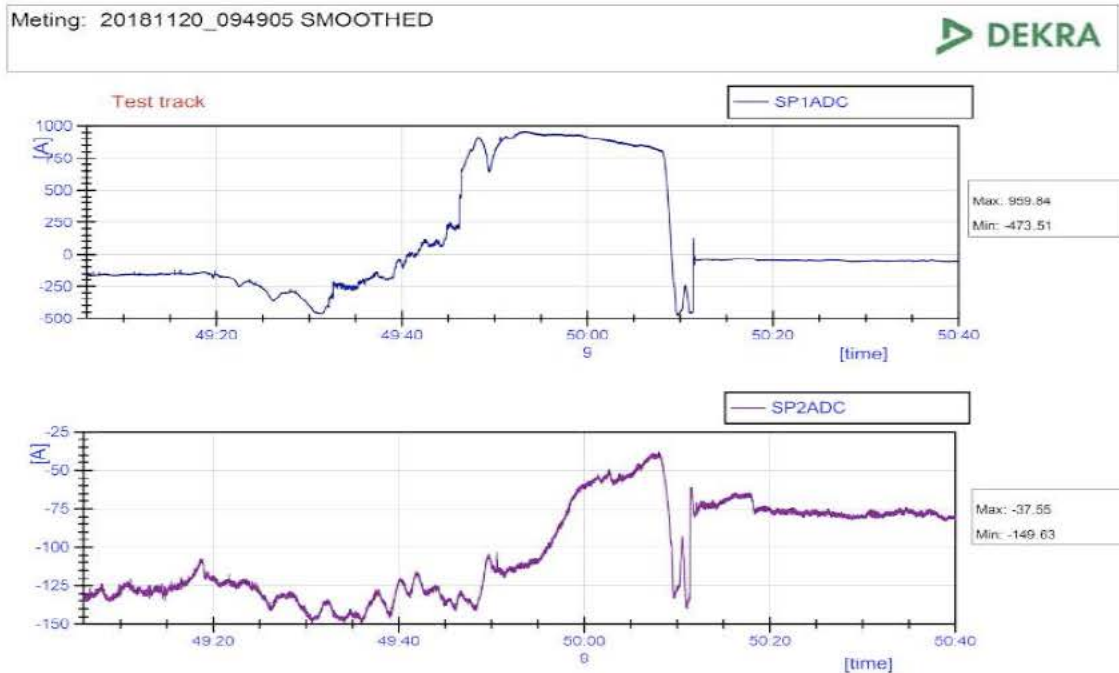

Measurement graphic:

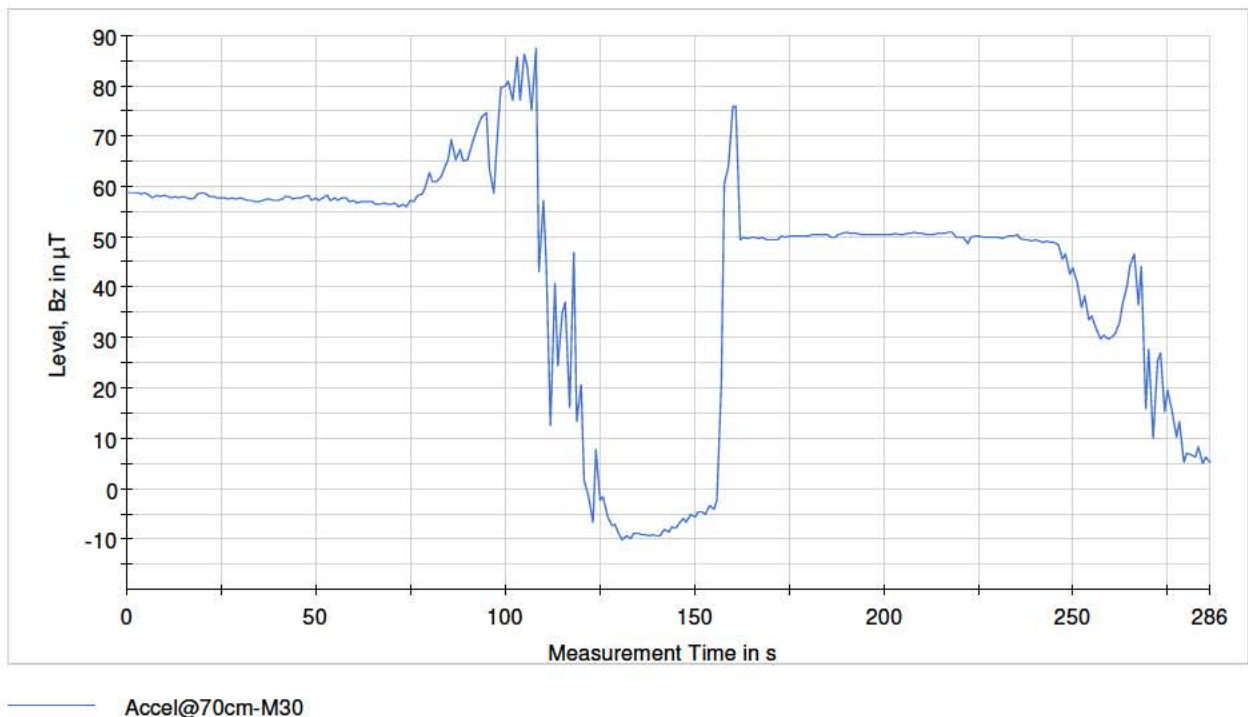

Date & Time	Direction	Operating condition / Train type	Train serial #		Estimated current during test [A]		Distance to track [m]	Height - sensor [m]	Remark
			1	2	Min	Max			
2018/11/20 15:19	W => O	Stoptrein (accel) / Flirt	2232	2512	-328	1248	1.25	0.7	P-2, Bx-axis

Current data:

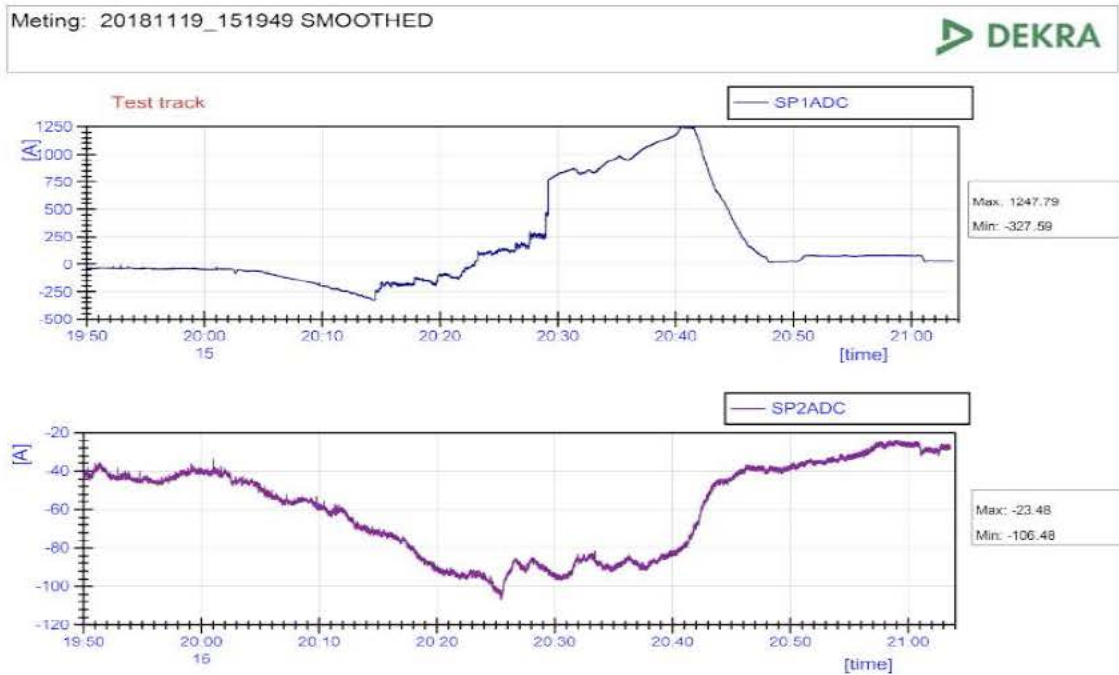

Measurement graphic:

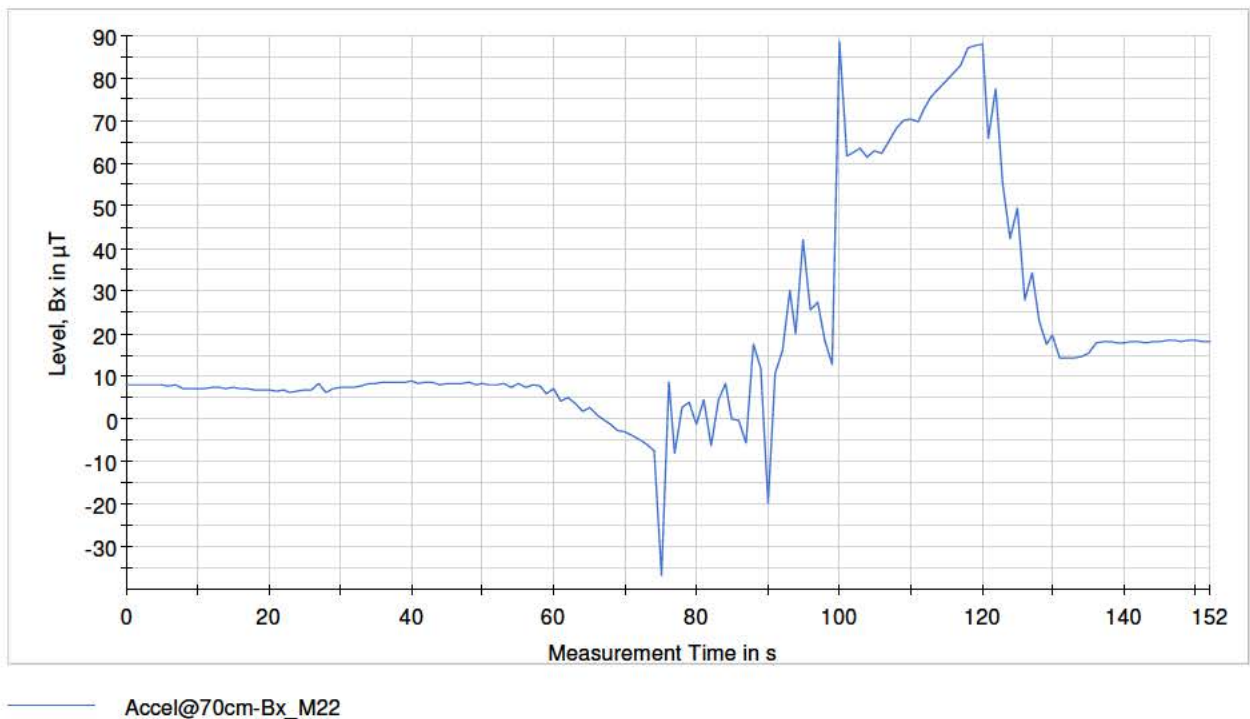

Date & Time	Direction	Operating condition / Train type	Train serial #		Estimated current during test [A]		Distance to track [m]	Height - sensor [m]	Remark
			1	2	Min	Max			
2018/11/20 16:49	W => O	Stoptrein (accel) / Flirt	---	---	-409	916	1.25	0.7	P-2, Bx-axis

Current data:

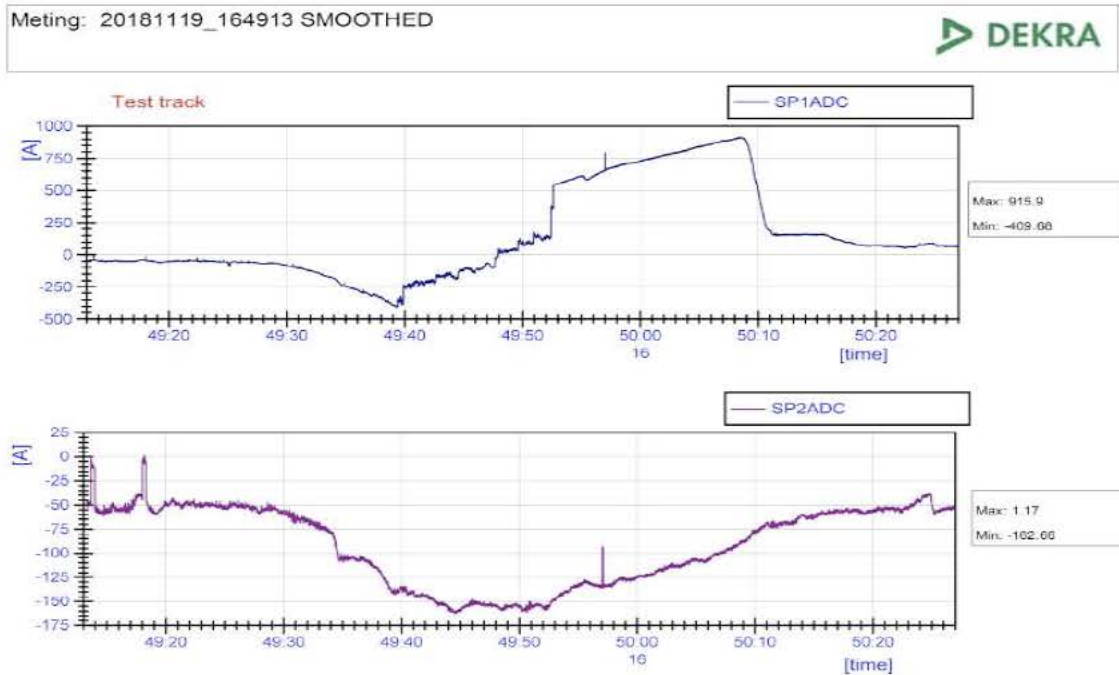

Measurement graphic:

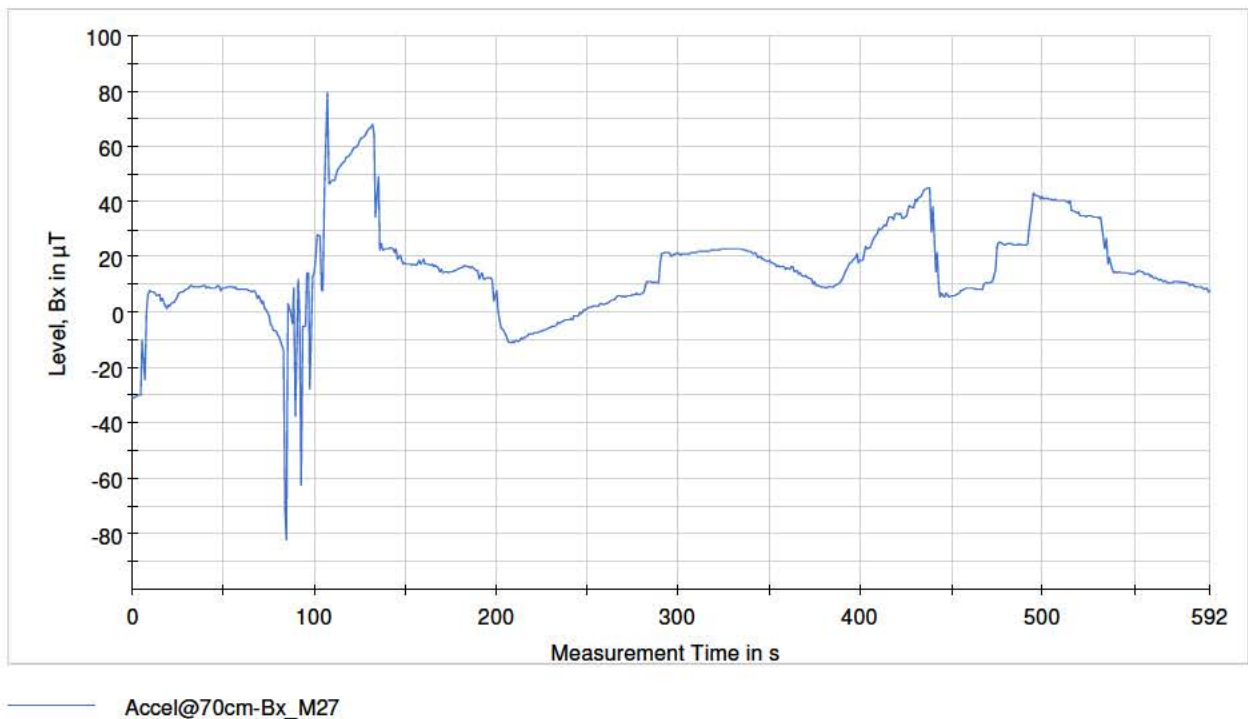

A1.11 Intercity-IC (transit), h=0.7 m., d=1.25 m.

Date & Time	Direction	Operating condition / Train type	Train serial #		Estimated current during test [A]		Distance to track [m]	Height - sensor [m]	Remark
			1	2	Min	Max			
2018/11/20 15:35	W => O	Intercity-IC (transit) / DDZ	7649	---	-244	48	1.25	0.7	P-2, Bz-axis

Current data:



Measurement graphic:

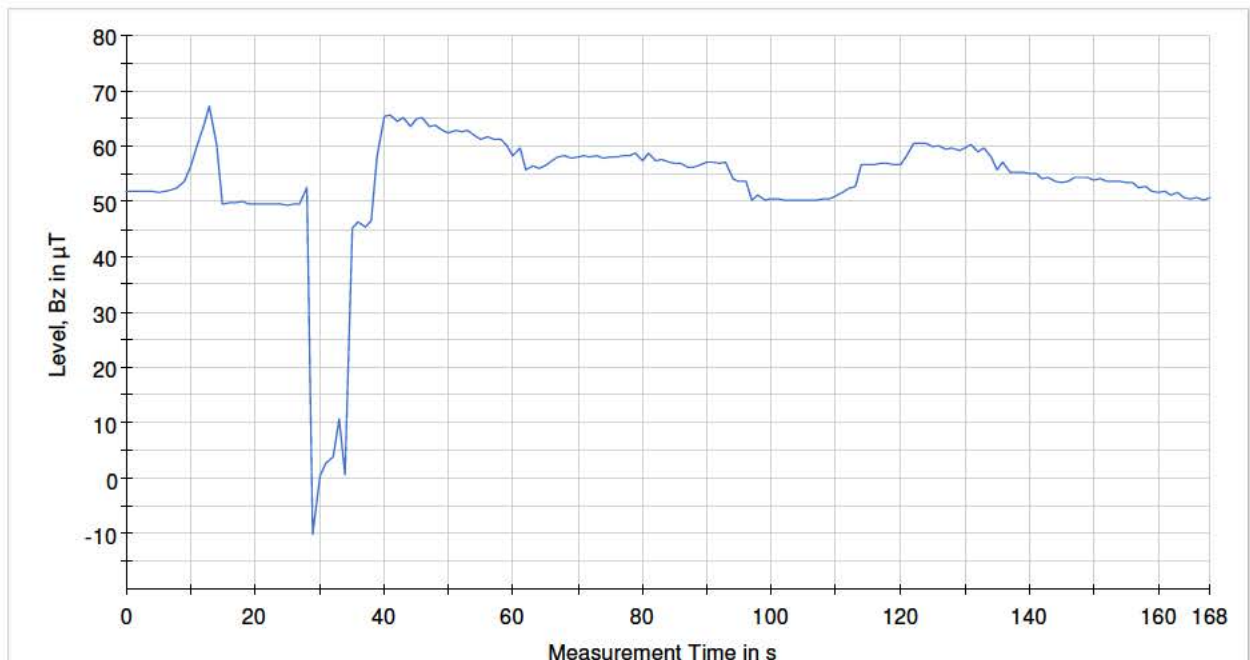

— Transit@70cm-Bz_M50

Date & Time	Direction	Operating condition / Train type	Train serial #		Estimated current during test [A]		Distance to track [m]	Height - sensor [m]	Remark
			1	2	Min	Max			
2018/11/20 16:04	W => O	Intercity-IC (transit) / ICM	4060	4028	-172	90	1.25	0.7	P-2, Bz-axis

Current data:

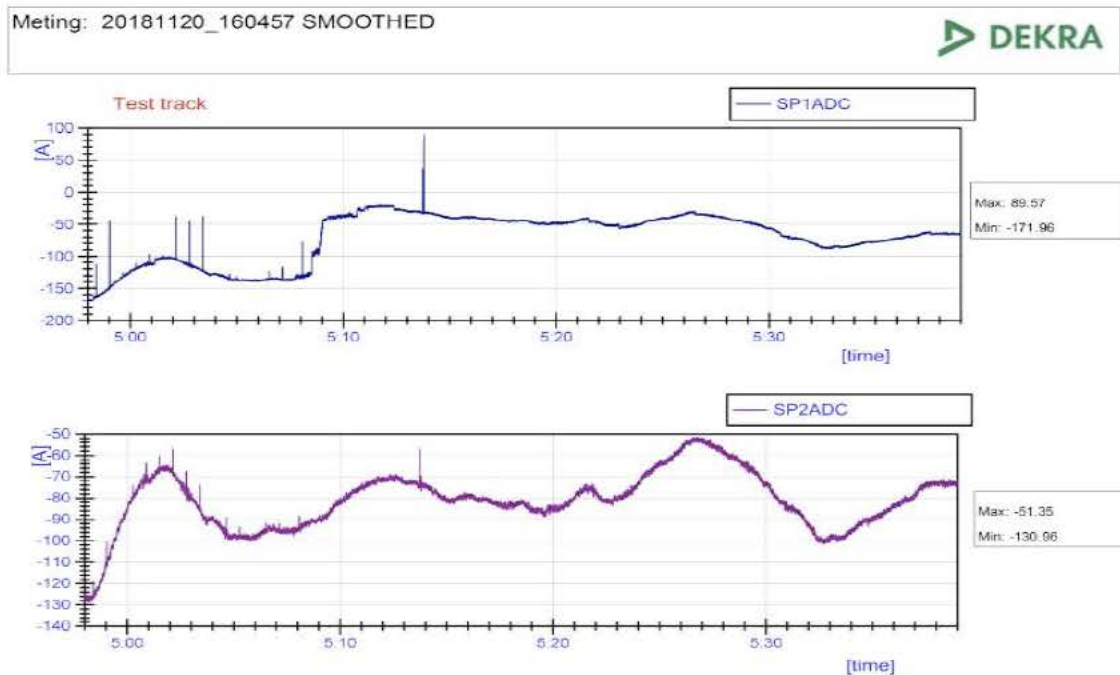

Measurement graphic:

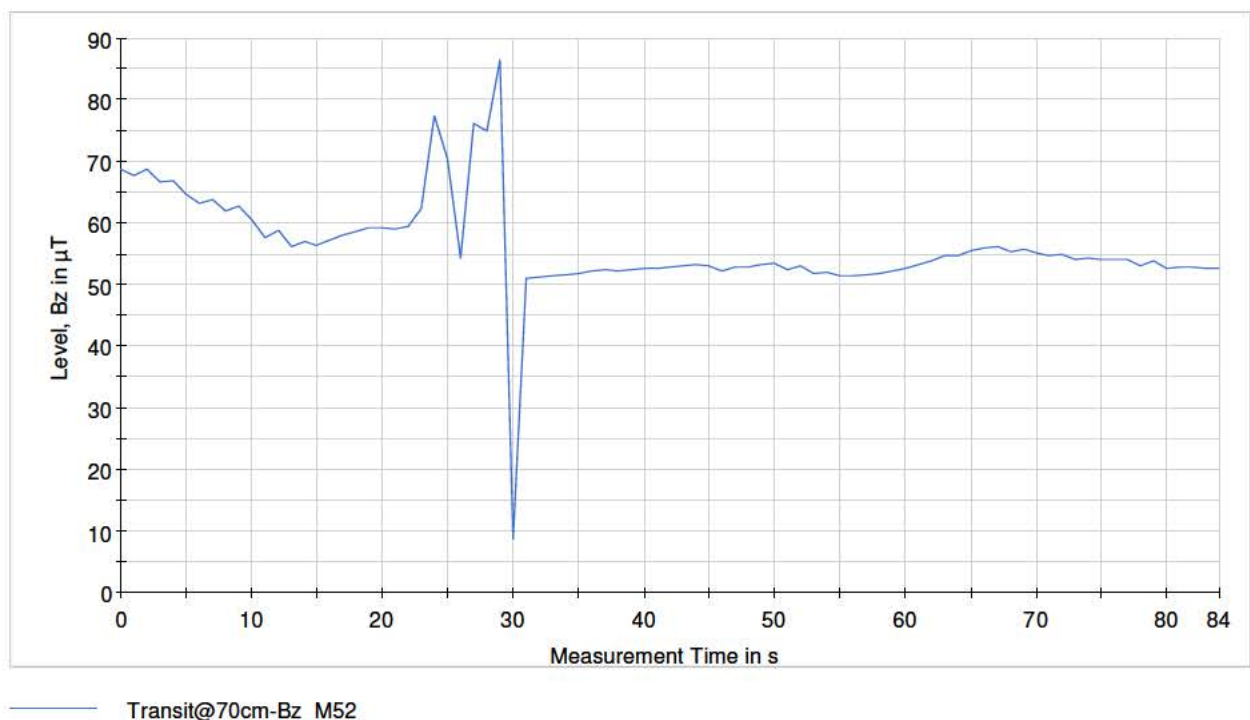

Date & Time	Direction	Operating condition / Train type	Train serial #		Estimated current during test [A]		Distance to track [m]	Height - sensor [m]	Remark
			1	2	Min	Max			
2018/11/19 16:35	W => O	Intercity-IC (transit) / ICM	---	---	-163	-20	1.25	0.7	P-2, Bx-axis

Current data:

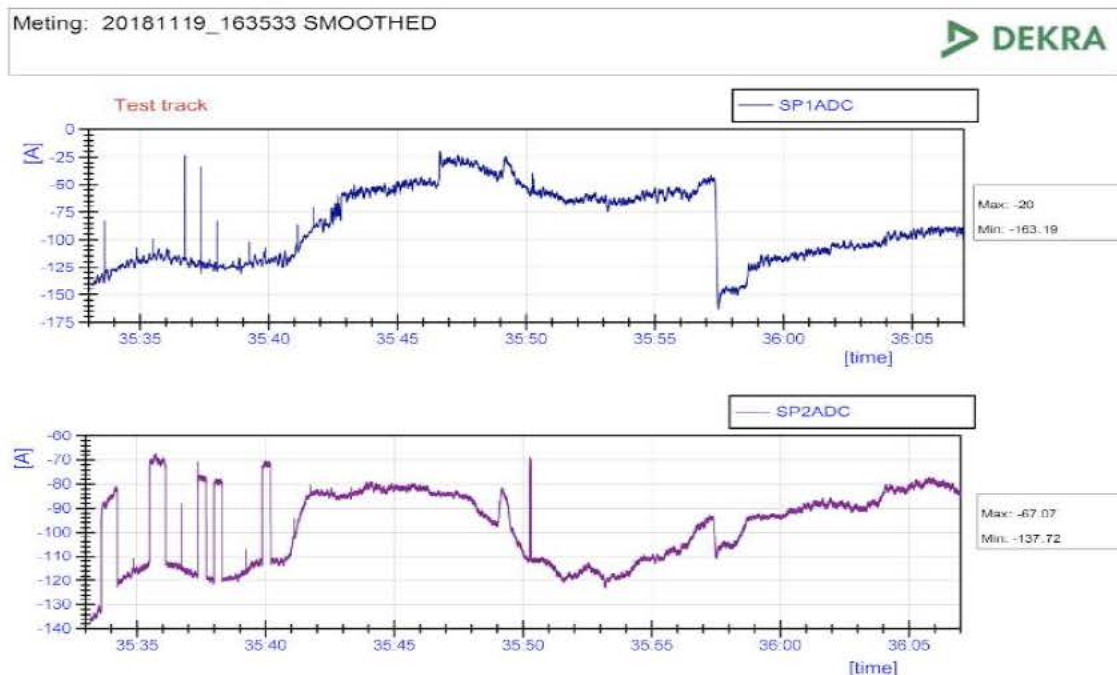

Measurement graphic:

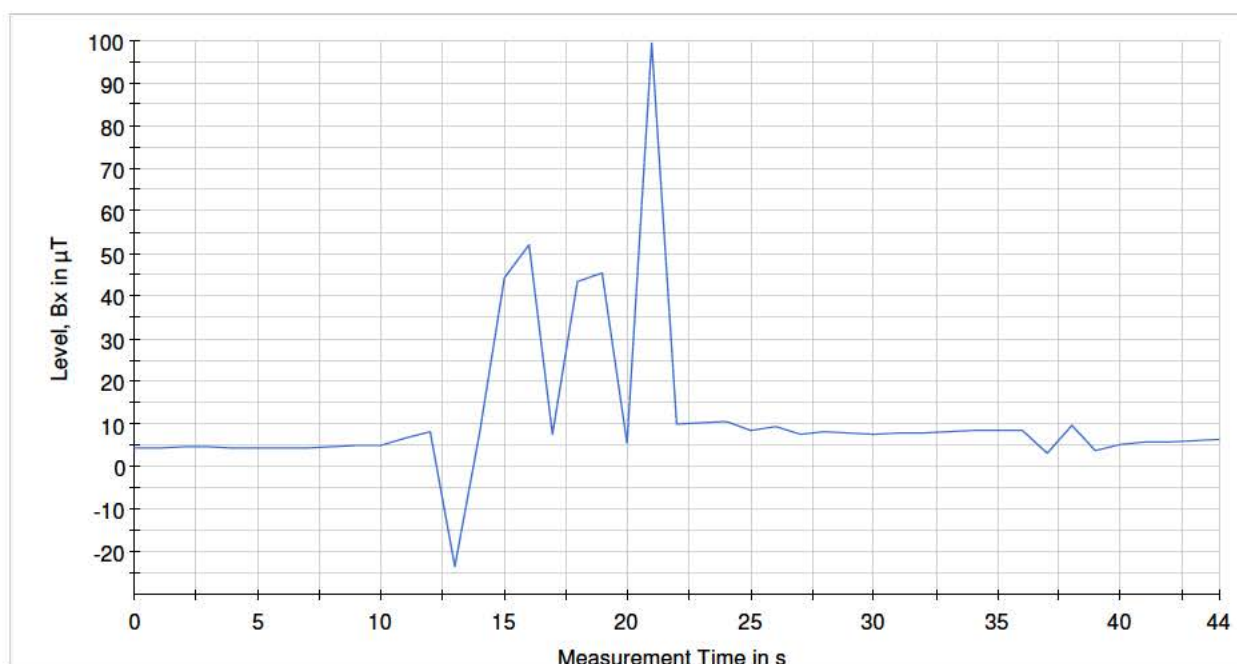

Transit@70cm-Bx_M26

A1.12 Braking (@SP2ADC), h=0.7 m., d=1.25 m.

Date & Time	Direction	Operating condition / Train type	Train serial #		Estimated current during test [A]		Distance to track [m]	Height - sensor [m]	Remark
			1	2	Min	Max			
2018/11/20 14:48	O => W	Braking (@SP2ADC) / VIRM	2219	2504	-612 -623	637 -84	1.25	0.7	P-2, Bx-axis, See 1)

1) Stoptrain at SP1ADC and braking train at SP2ADC.

Current data:

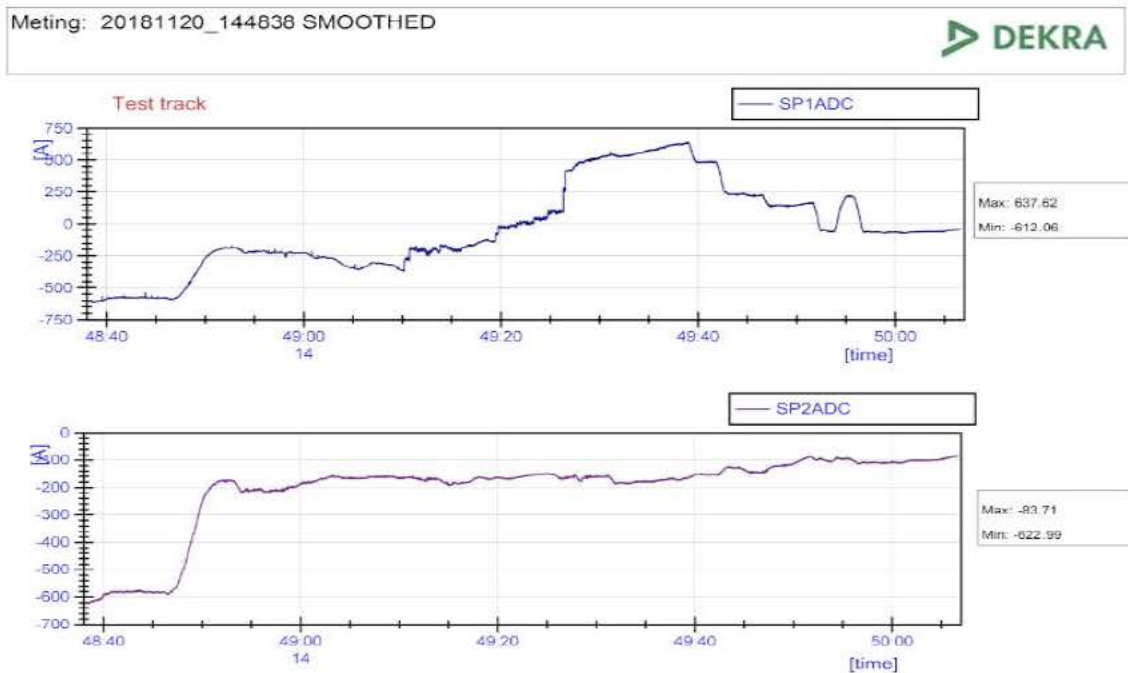

Measurement graphic:

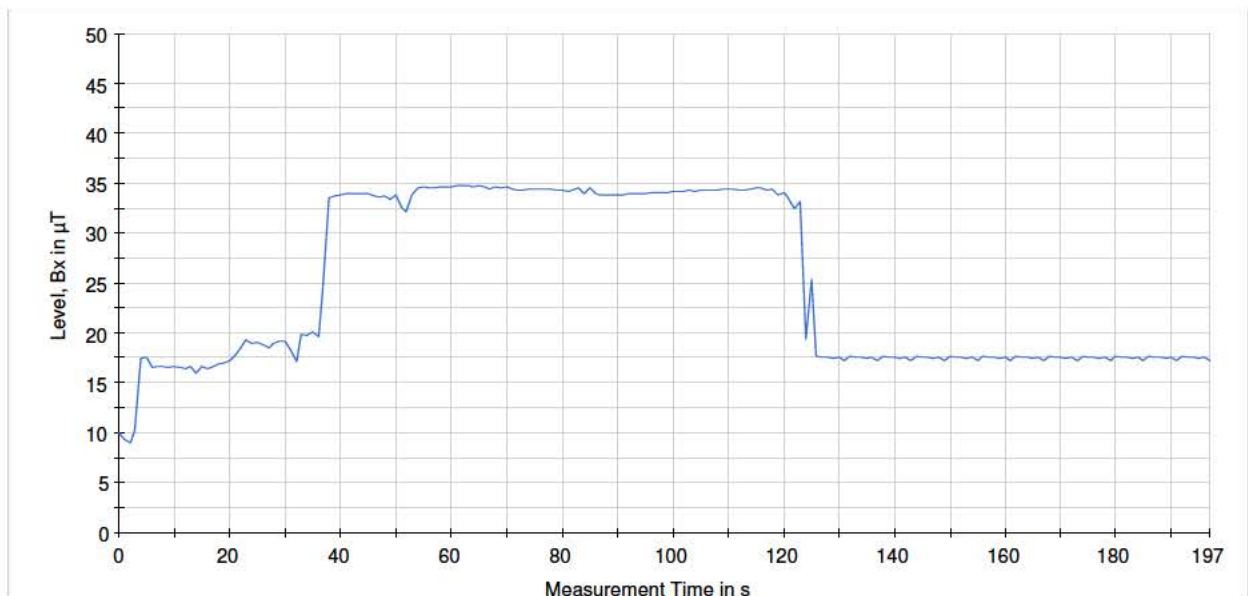

Braking-SP2ADC@70cm-Bx_M46

A1.13 Stoptrein (acceleration), h=1 m., d=1.25 m.

Date & Time	Direction	Operating condition / Train type	Train serial #		Estimated current during test [A]		Distance to track [m]	Height - sensor [m]	Remark
			1	2	Min	Max			
2018/11/20 10:18	W => O	Stoptrein (accel) / Flirt	2510	2209	-354	847	1.25	1	P-2, Bz-axis

Current data:

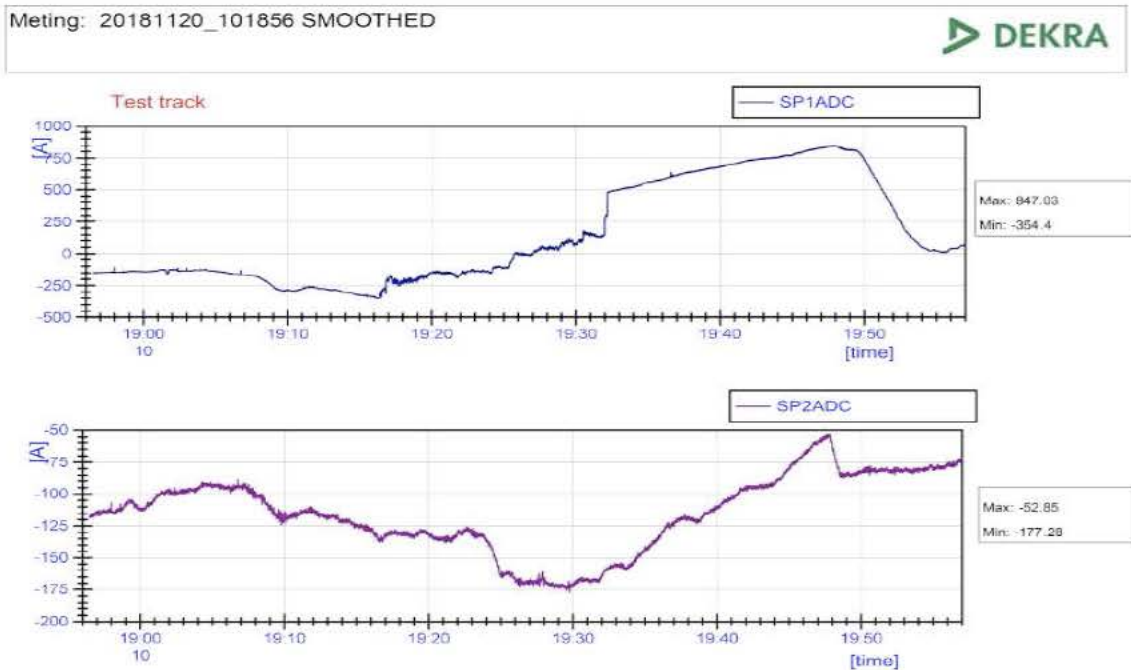

Measurement graphic:

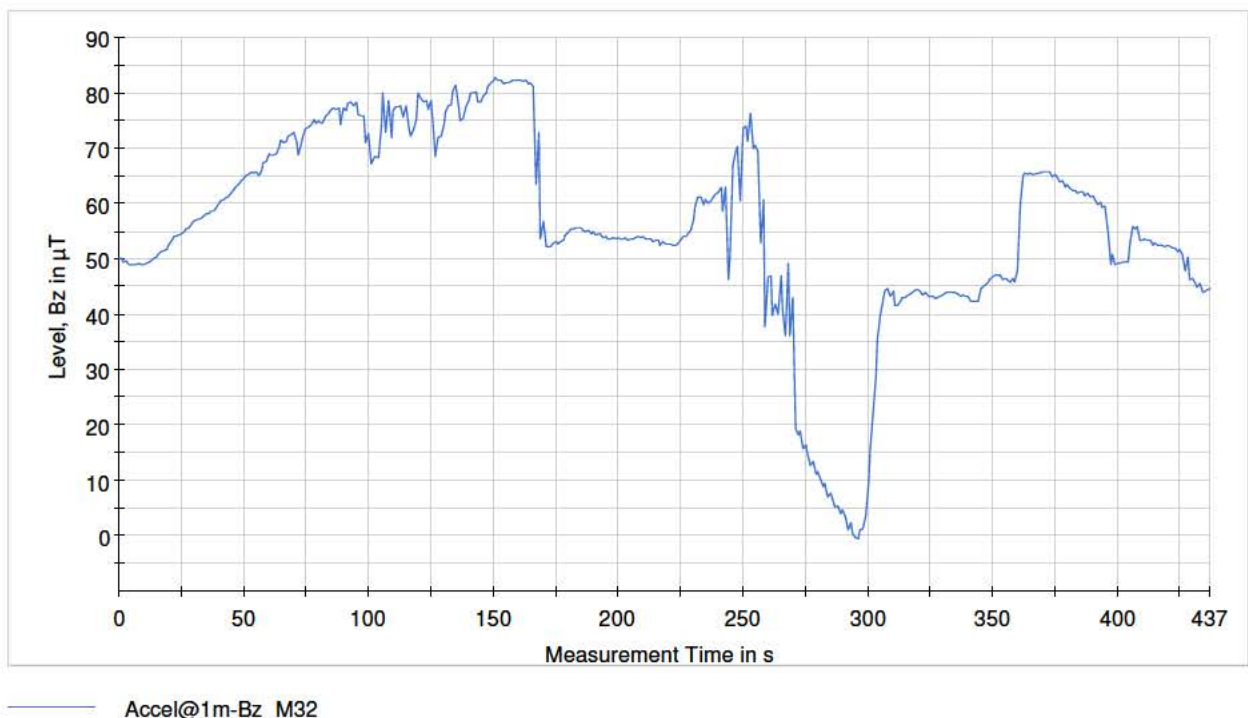

Date & Time	Direction	Operating condition / Train type	Train serial #		Estimated current during test [A]		Distance to track [m]	Height - sensor [m]	Remark
			1	2	Min	Max			
2018/11/20 10:48	W => O	Stoptrein (accel) / Flirt	2224	2212	-686	808	1.25	1	P-2, Bz-axis

Current data:

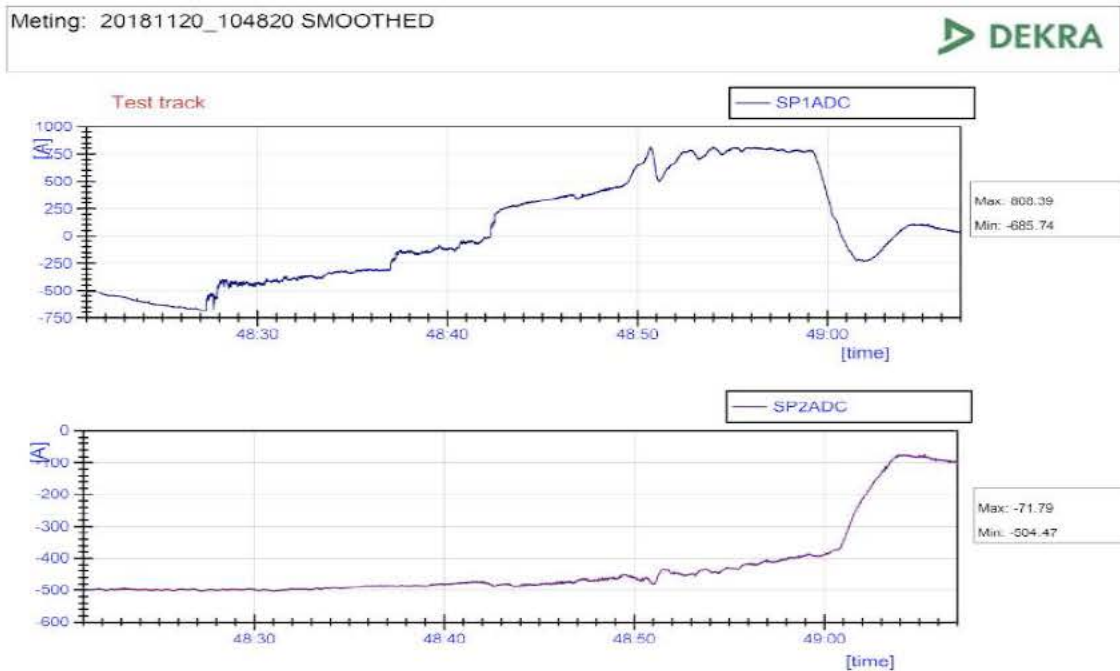

Measurement graphic:

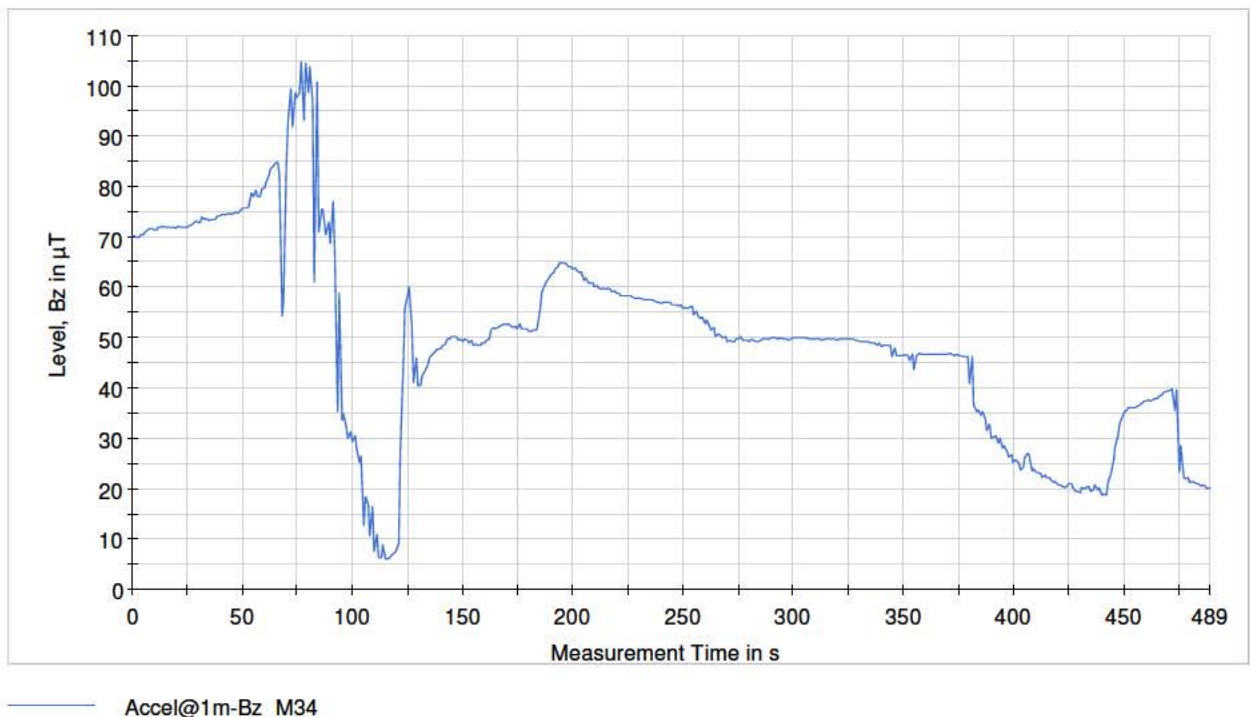

Date & Time	Direction	Operating condition / Train type	Train serial #		Estimated current during test [A]		Distance to track [m]	Height - sensor [m]	Remark
			1	2	Min	Max			
2018/11/20 11:18	W => O	Stoptrein (accel) / Flirt	2517	2215	-1007	422	1.25	1	P-2, Bz-axis

Current data:

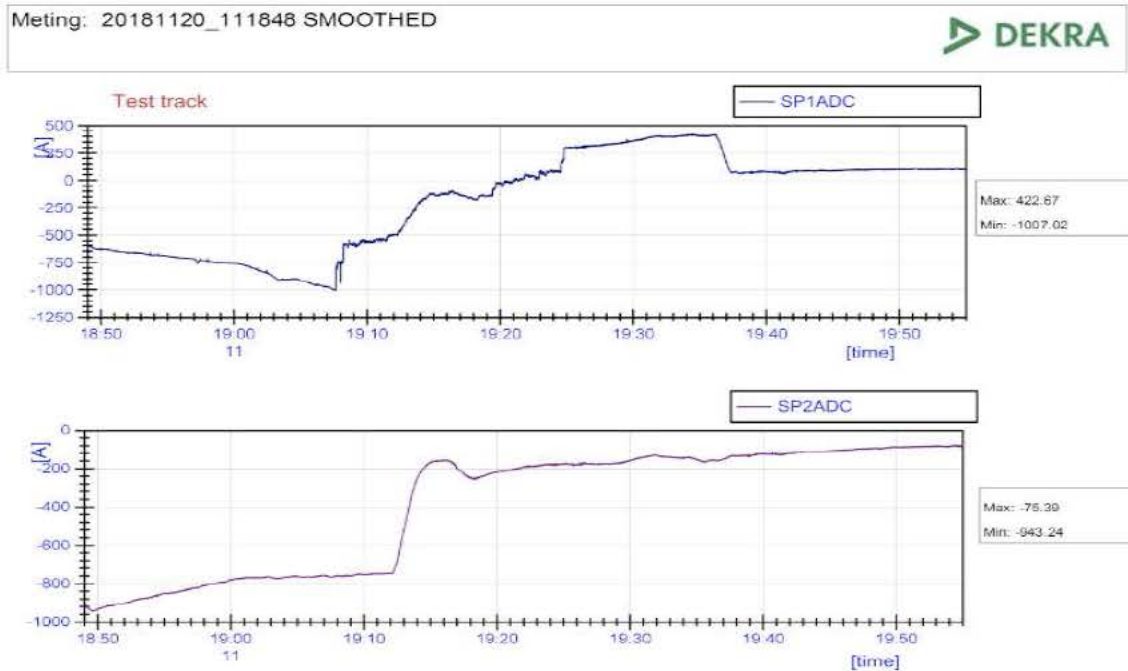

Measurement graphic:

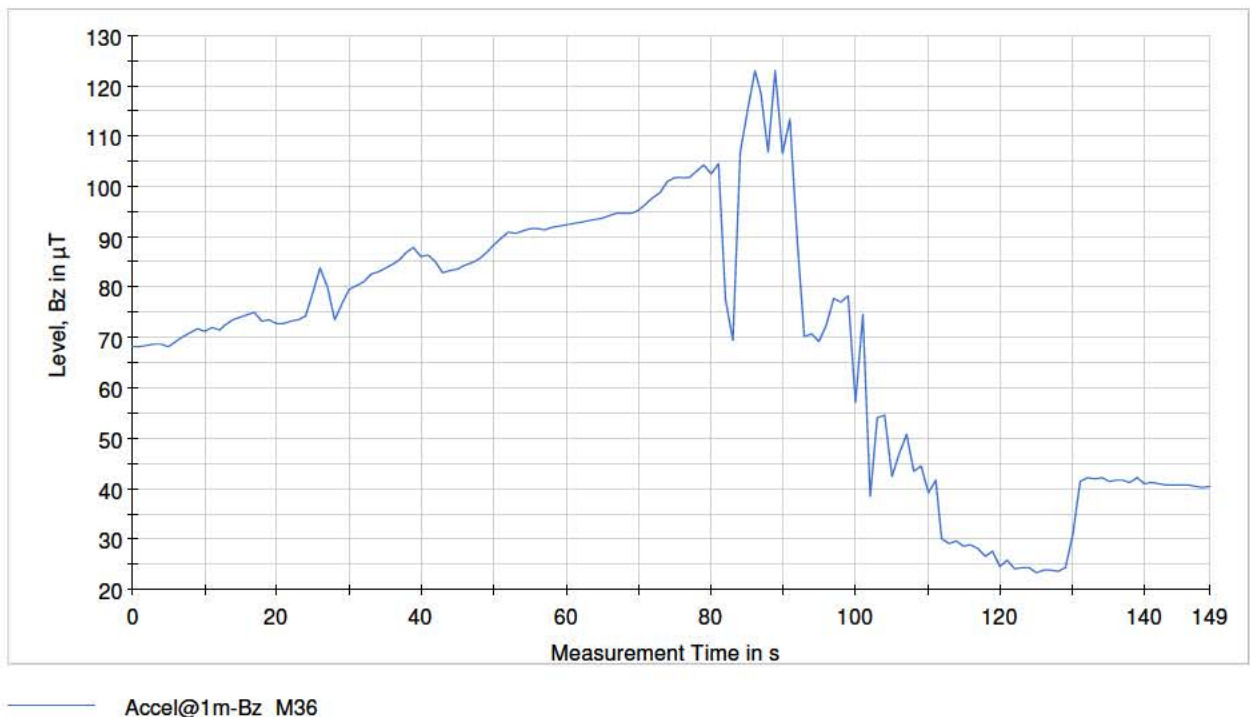

Date & Time	Direction	Operating condition / Train type	Train serial #		Estimated current during test [A]		Distance to track [m]	Height - sensor [m]	Remark
			1	2	Min	Max			
2018/11/20 12:16	W => O	Stoptrein (accel) / Flirt	---	---	---	---	1.25	1	P-2, Bx-axis

Current data:

No current data is available. The current of the track was not able to be measured due to the technical problems of the measuring equipment.

Measurement graphic:

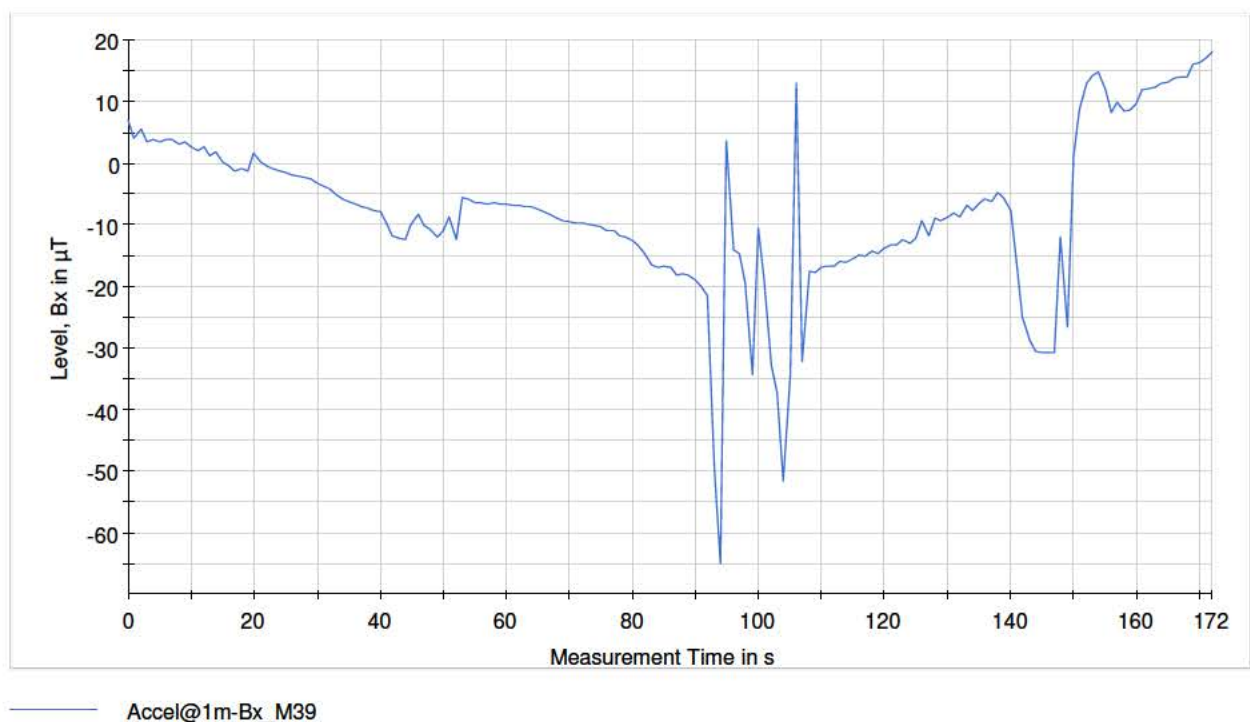

Date & Time	Direction	Operating condition / Train type	Train serial #		Estimated current during test [A]		Distance to track [m]	Height - sensor [m]	Remark
			1	2	Min	Max			
2018/11/20 12:48	W => O	Stoptrein (accel) / Flirt	2507	2211	-253	459	1.25	1	P-2, Bx-axis

Current data:

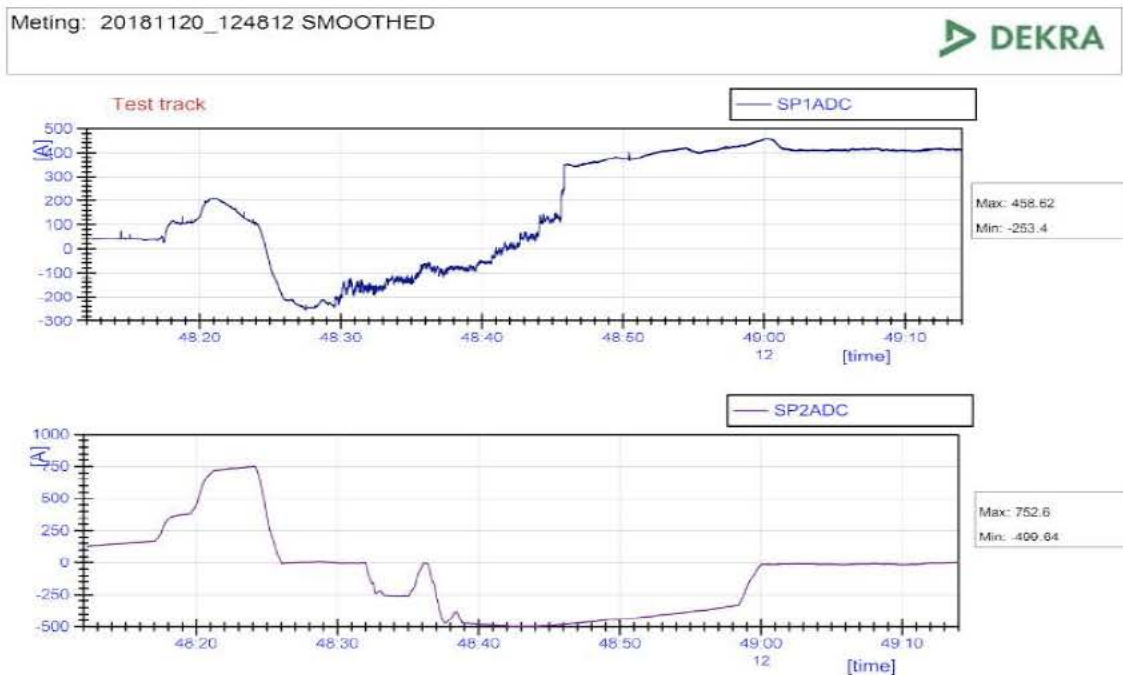

Measurement graphic:

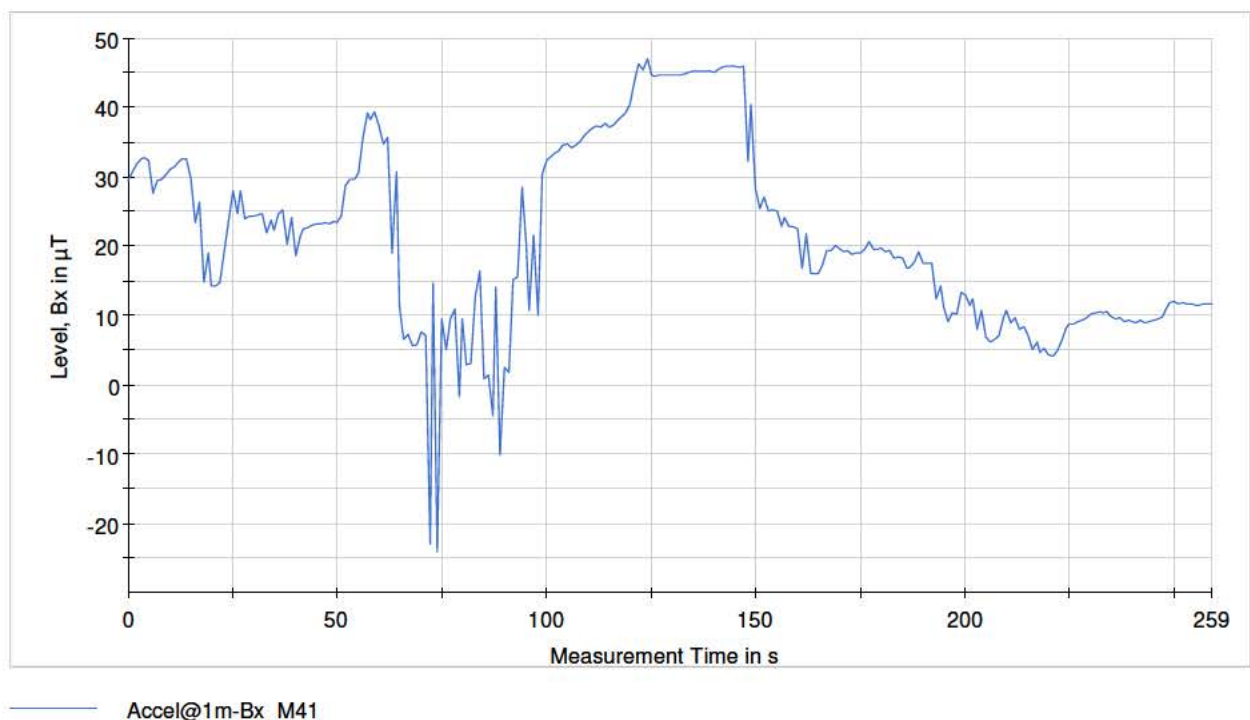

A1.14 Intercity-IC (transit), h=1 m., d=1.25 m.

Date & Time	Direction	Operating condition / Train type	Train serial #		Estimated current during test [A]		Distance to track [m]	Height - sensor [m]	Remark
			1	2	Min	Max			
2018/11/20 10:34	W => O	Intercity-IC (transit) / DDZ	7635	---	-197	45	1.25	1	P-2, Bz-axis

Current data:

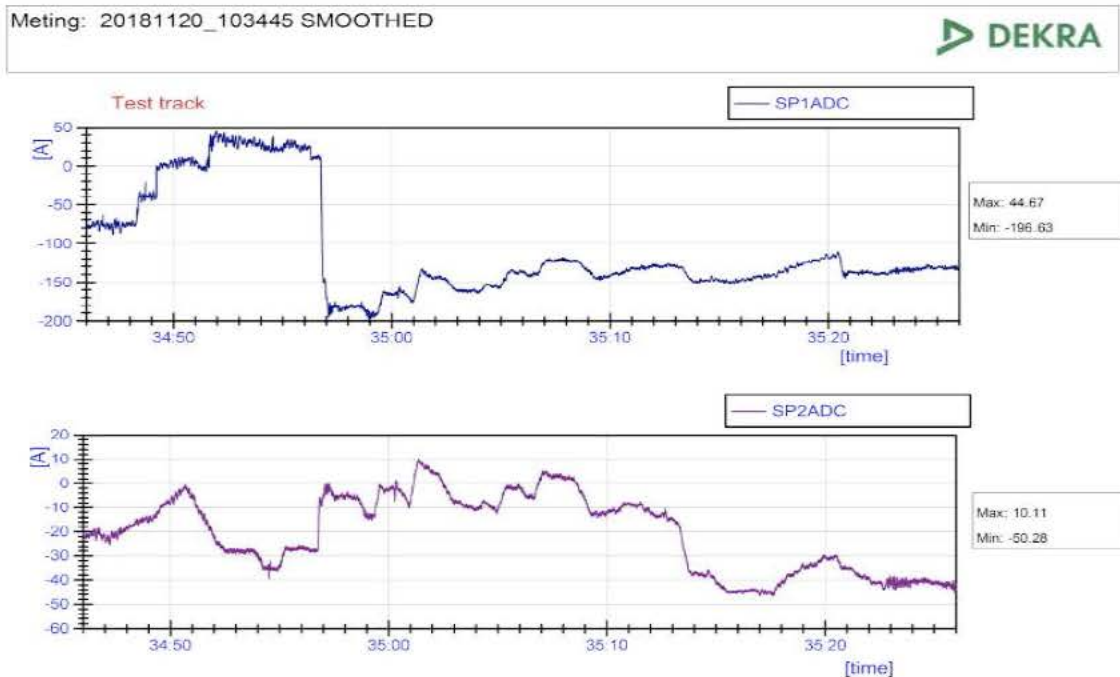

Measurement graphic:

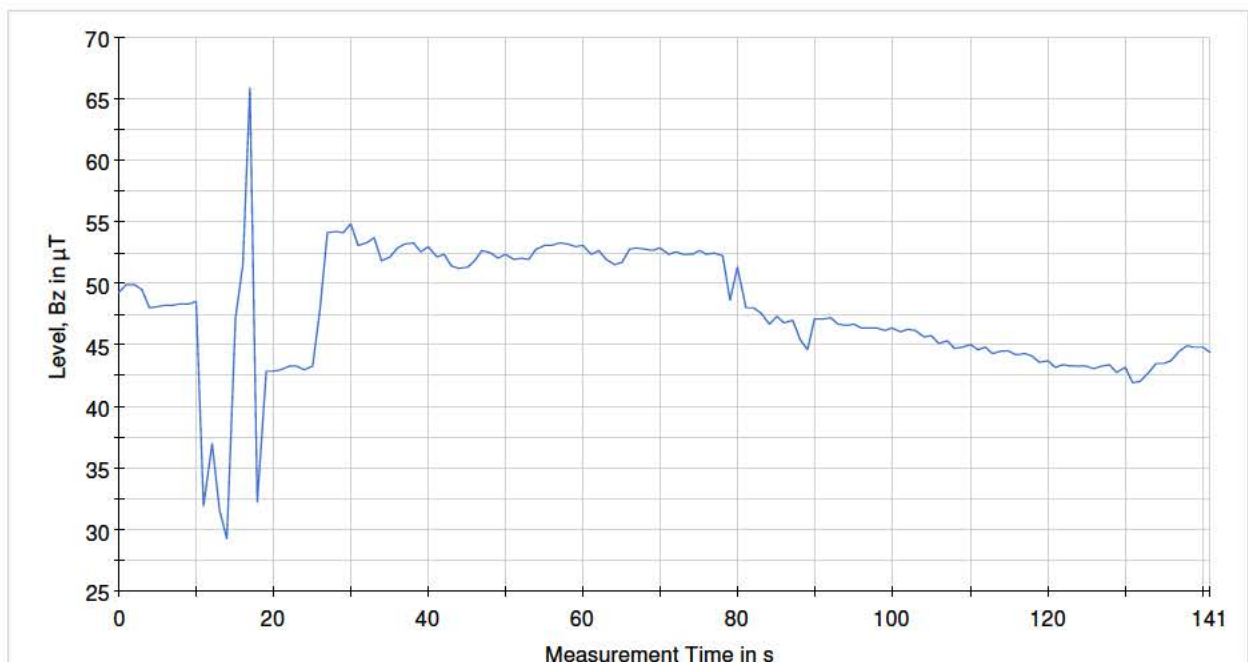

Transit@1m-Bz_M33

Date & Time	Direction	Operating condition / Train type	Train serial #		Estimated current during test [A]		Distance to track [m]	Height - sensor [m]	Remark
			1	2	Min	Max			
2018/11/20 11:34	W => O	Intercity-IC (transit) / DDZ	7620	---	-290	291	1.25	1	P-2, Bz-axis

Current data:

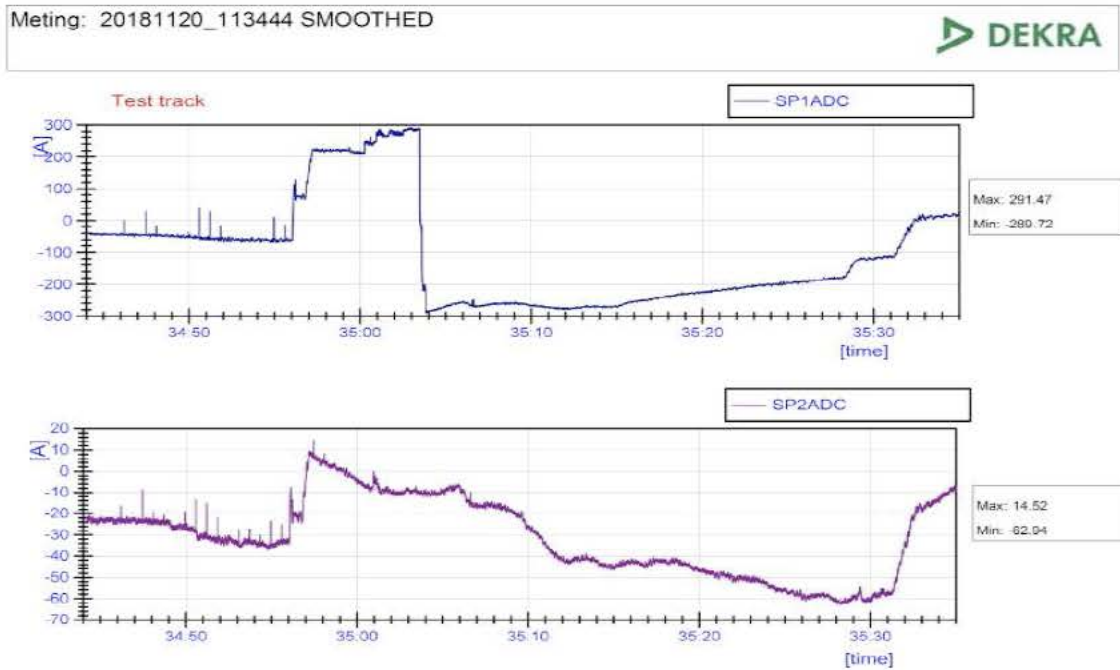

Measurement graphic:

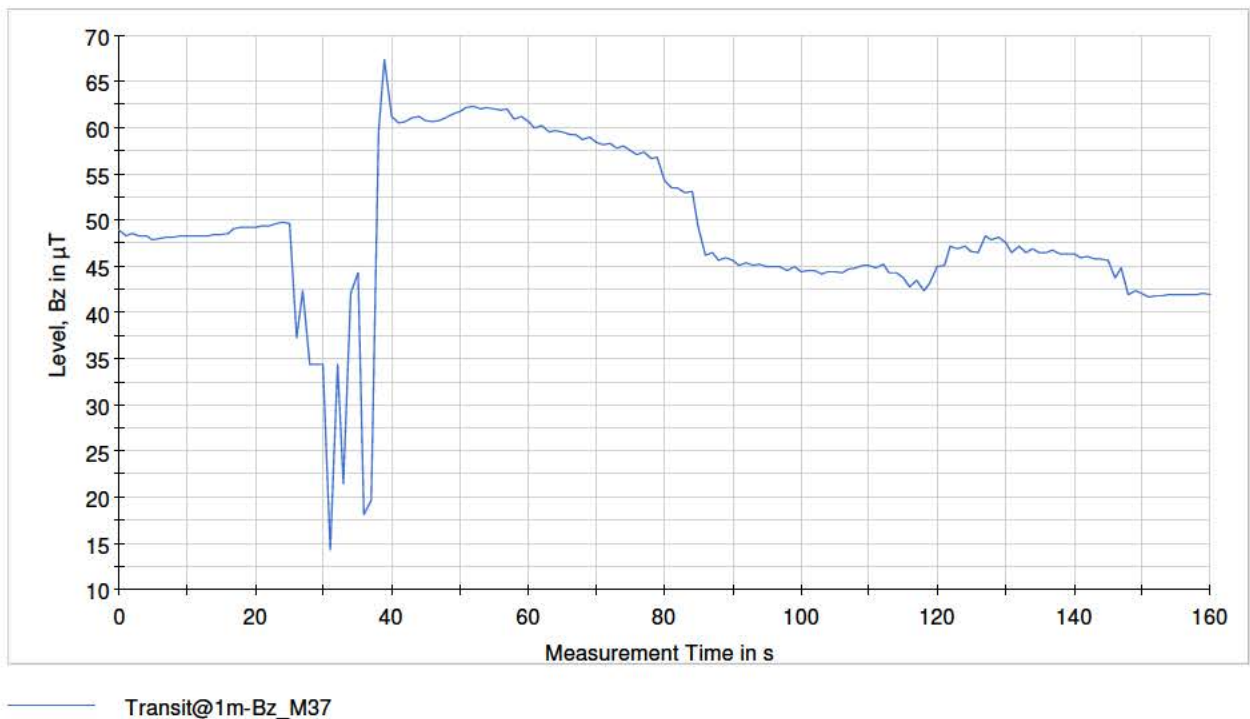

Date & Time	Direction	Operating condition / Train type	Train serial #		Estimated current during test [A]		Distance to track [m]	Height - sensor [m]	Remark
			1	2	Min	Max			
2018/11/20 12:04	W => O	Intercity-IC (transit) / ICM	4247	---	-56	21	1.25	1	P-2, Bx-axis

Current data:

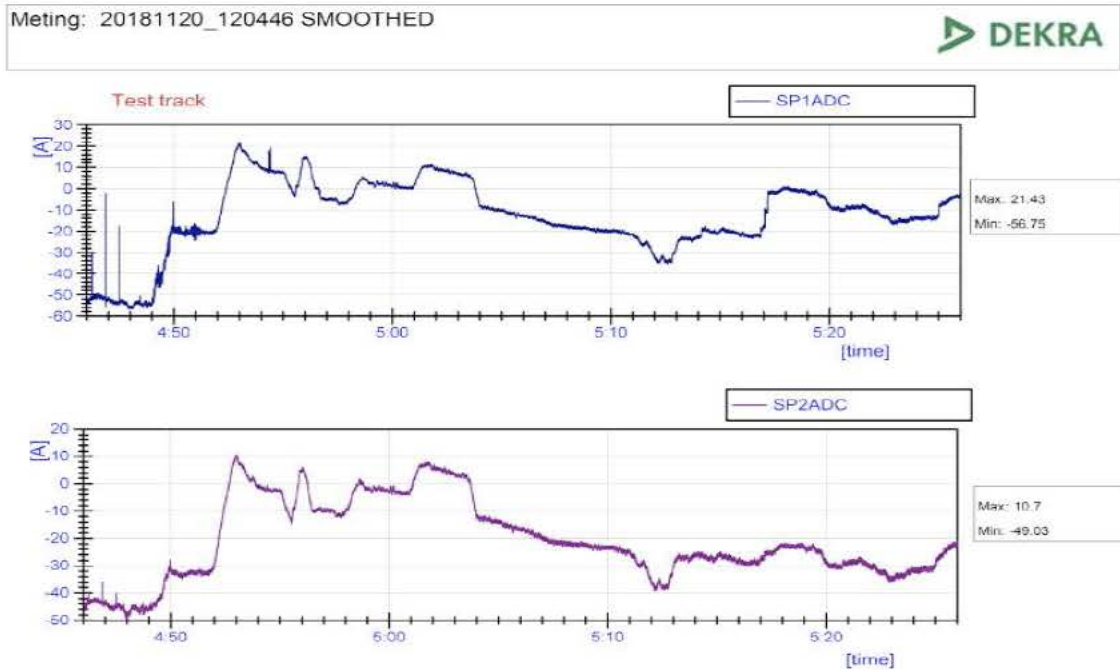

Measurement graphic:

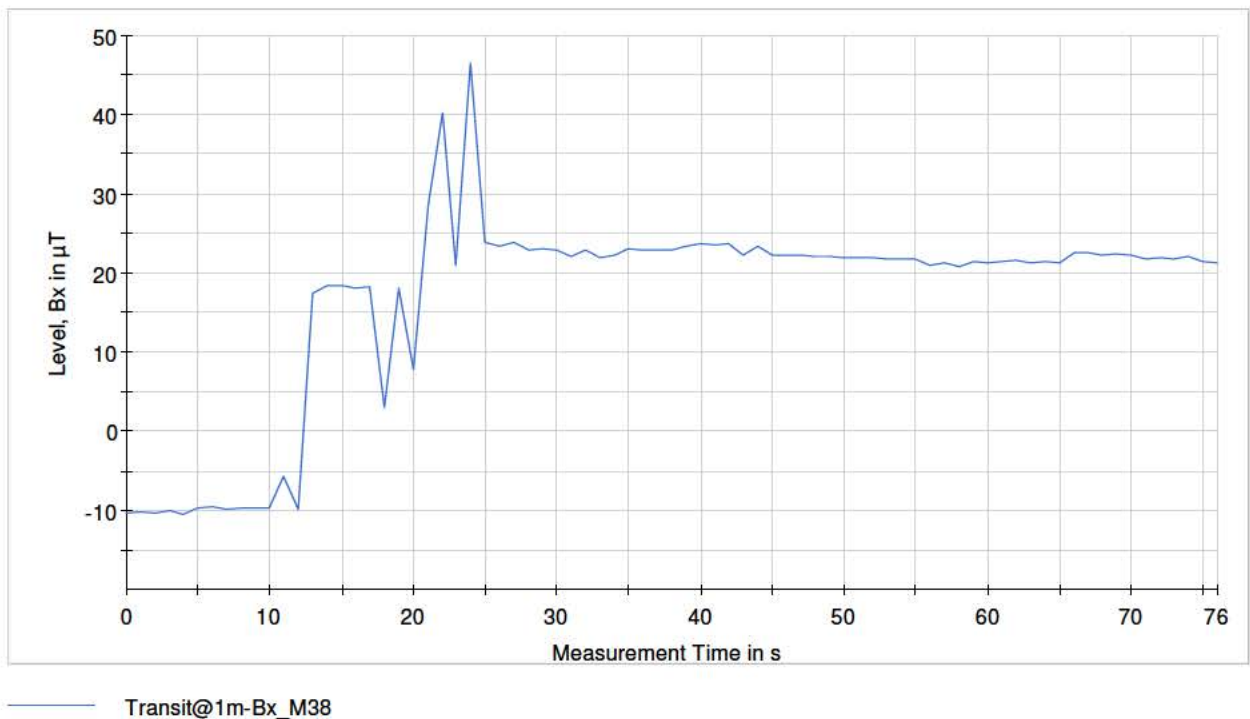

Date & Time	Direction	Operating condition / Train type	Train serial #		Estimated current during test [A]		Distance to track [m]	Height - sensor [m]	Remark
			1	2	Min	Max			
2018/11/20 12:34	W => O	Intercity-IC (transit) / DDZ	7534	---	-221	168	1.25	1	P-2, Bx-axis

Current data:



Measurement graphic:

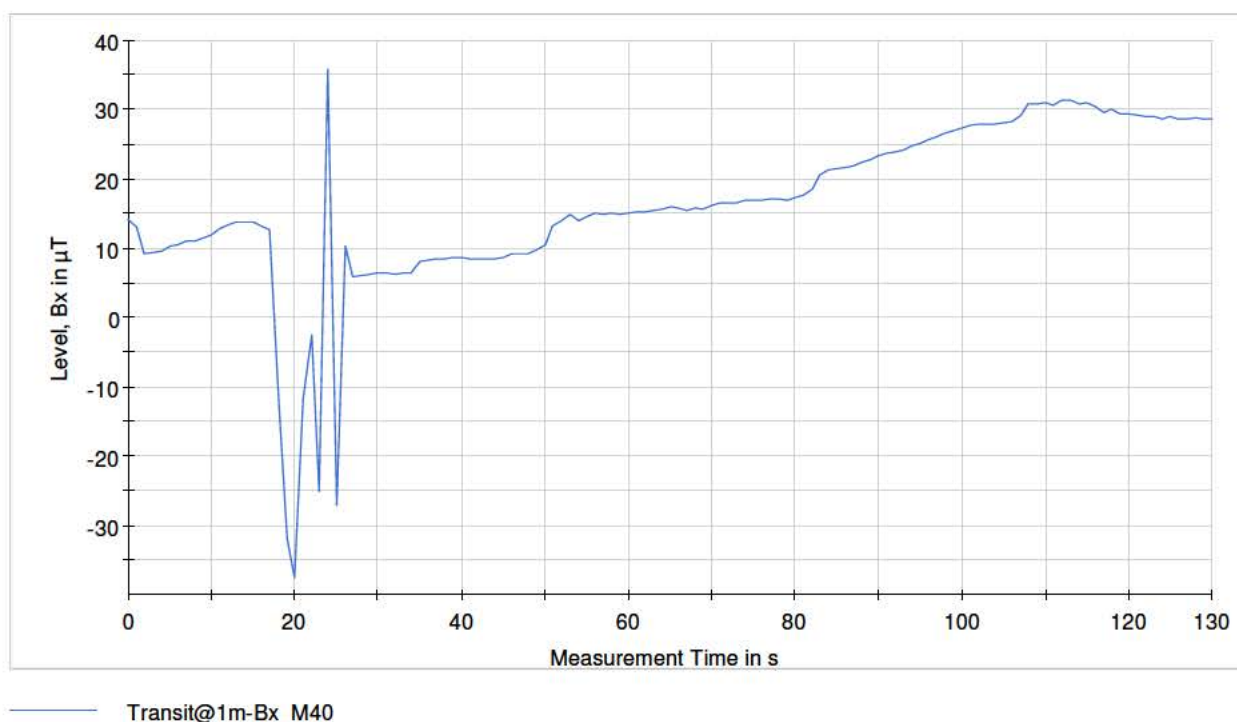

A1.15 Stoptrein (acceleration), h=0.3 m., d=3 m.

Date & Time	Direction	Operating condition / Train type	Train serial #		Estimated current during test [A]		Distance to track [m]	Height - sensor [m]	Remark
			1	2	Min	Max			
2018/11/21 13:48	W => O	Stoptrein (accel) / Flirt	2231	---	-646	279	3	0.3	P-3, Bz-axis

Current data:

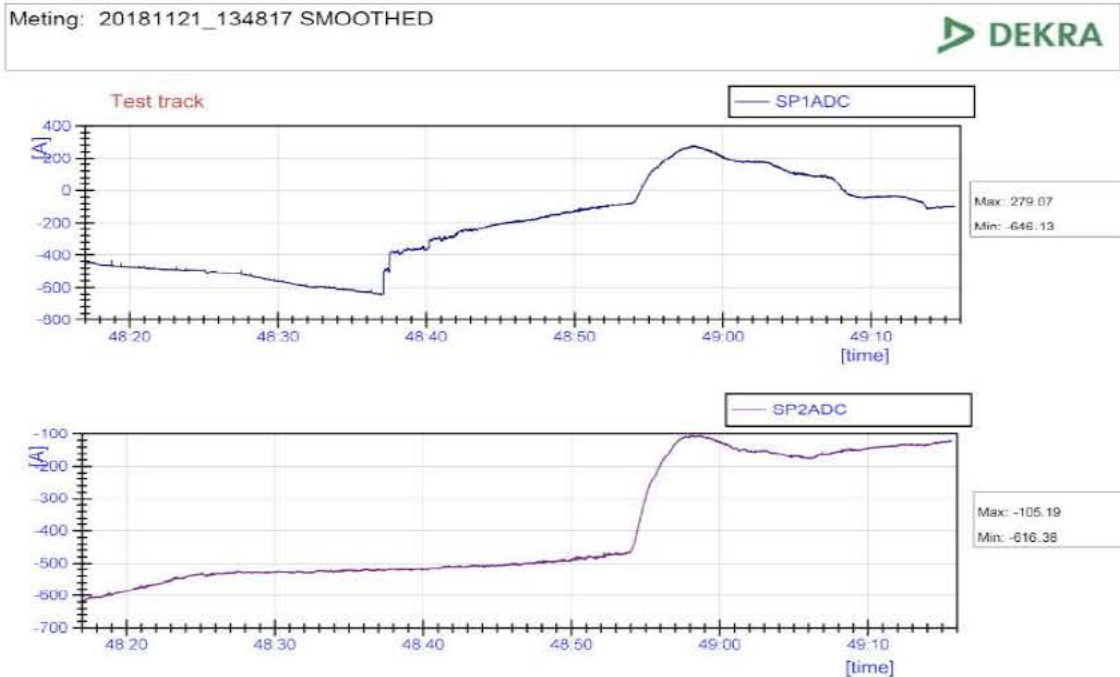

Measurement graphic:

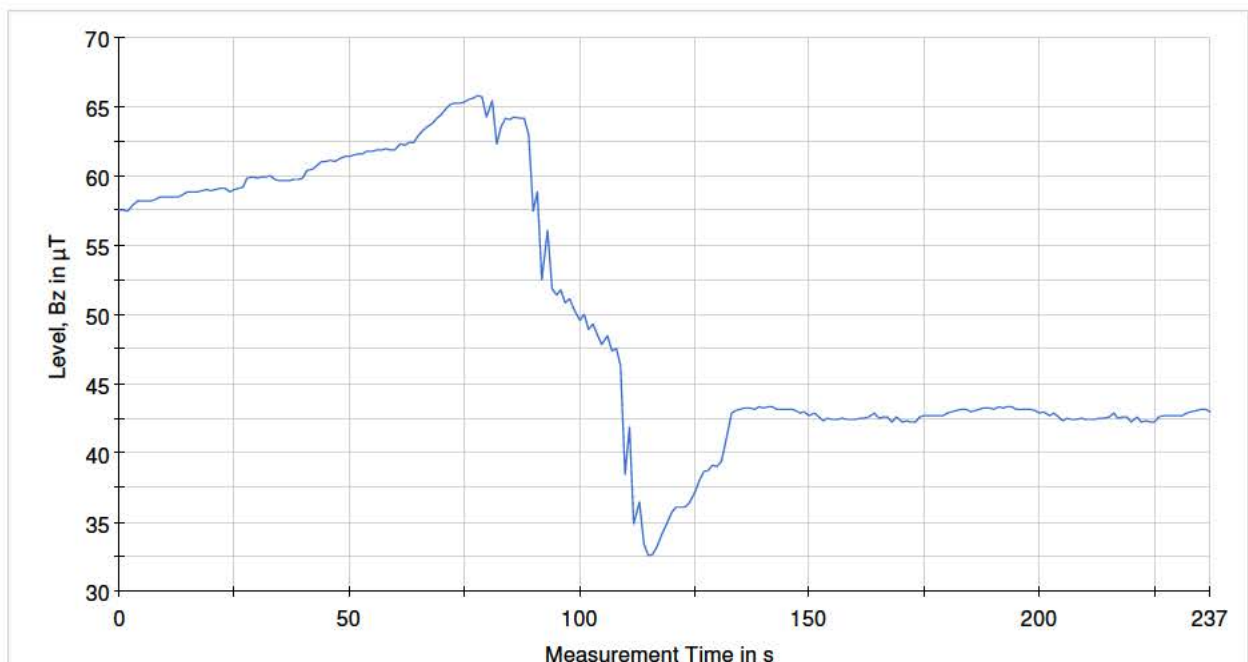

Accel@30cm-Bz_M76

Date & Time	Direction	Operating condition / Train type	Train serial #		Estimated current during test [A]		Distance to track [m]	Height - sensor [m]	Remark
			1	2	Min	Max			
2018/11/21 15:17	W => O	Stoptrein (accel) / Flirt	2504	2219	-512	1251	3	0.3	P-3, Bx-axis

Current data:

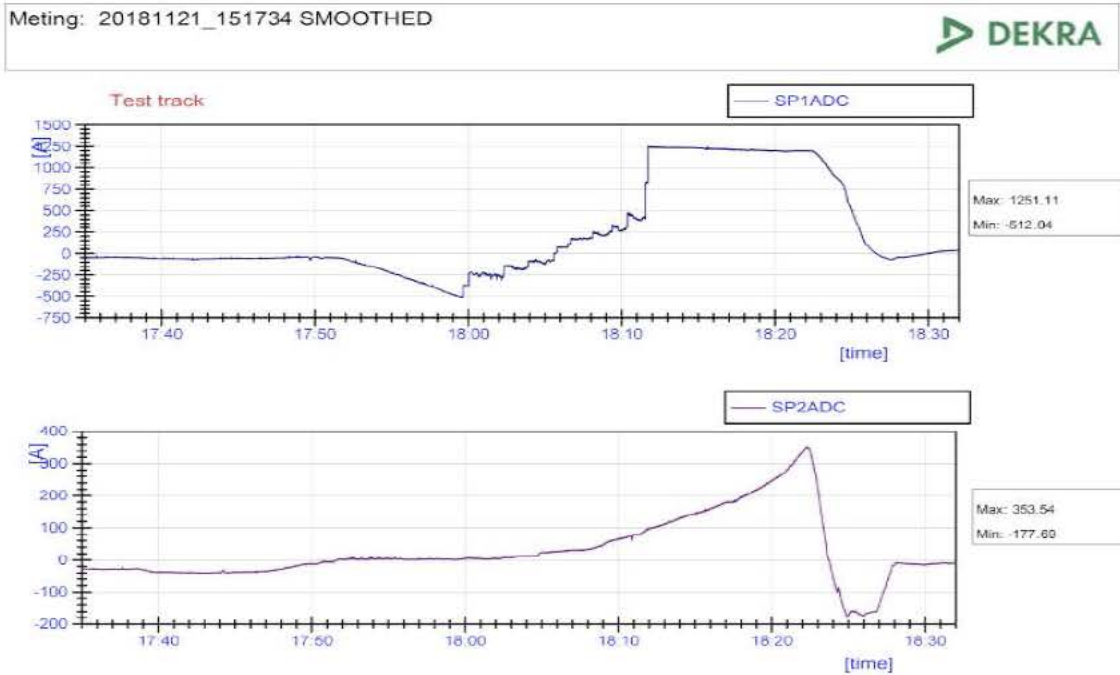

Measurement graphic:

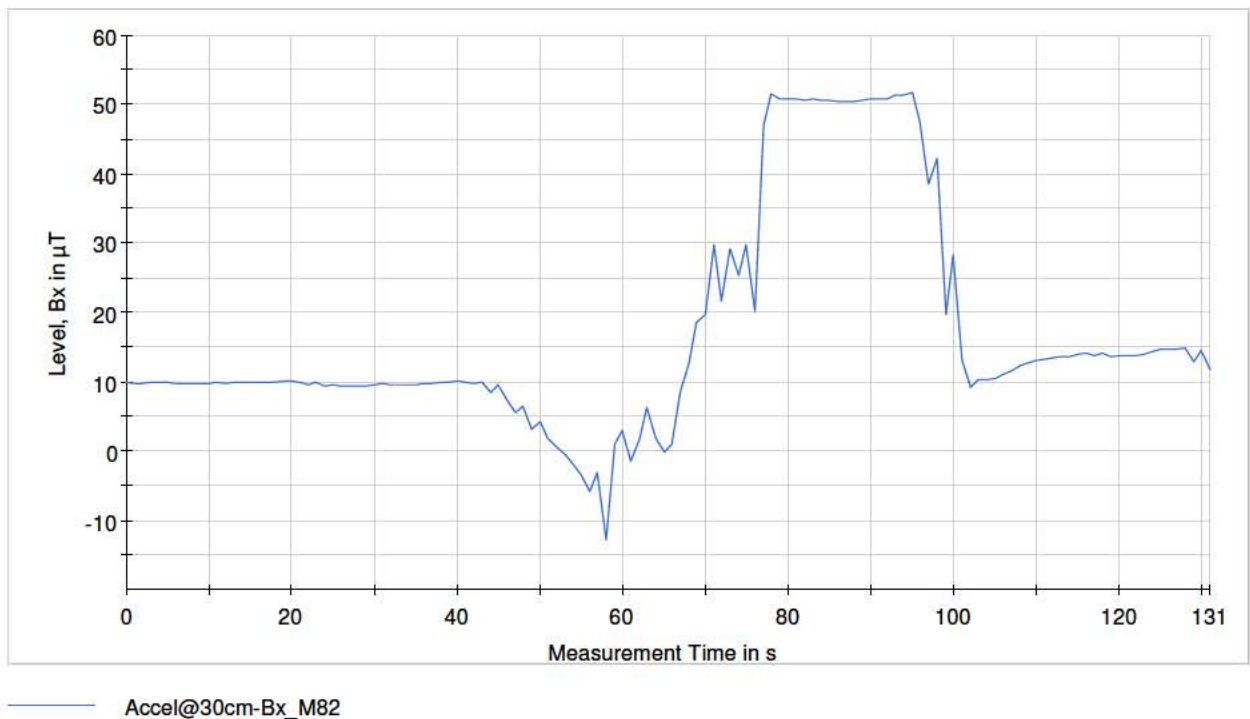

Date & Time	Direction	Operating condition / Train type	Train serial #		Estimated current during test [A]		Distance to track [m]	Height - sensor [m]	Remark
			1	2	Min	Max			
2018/11/21 12:18	W => O	Stoptrein (accel) / Flirt	2510	---	-718	321	3	0.3	P-3, By-axis

Current data:



Measurement graphic:

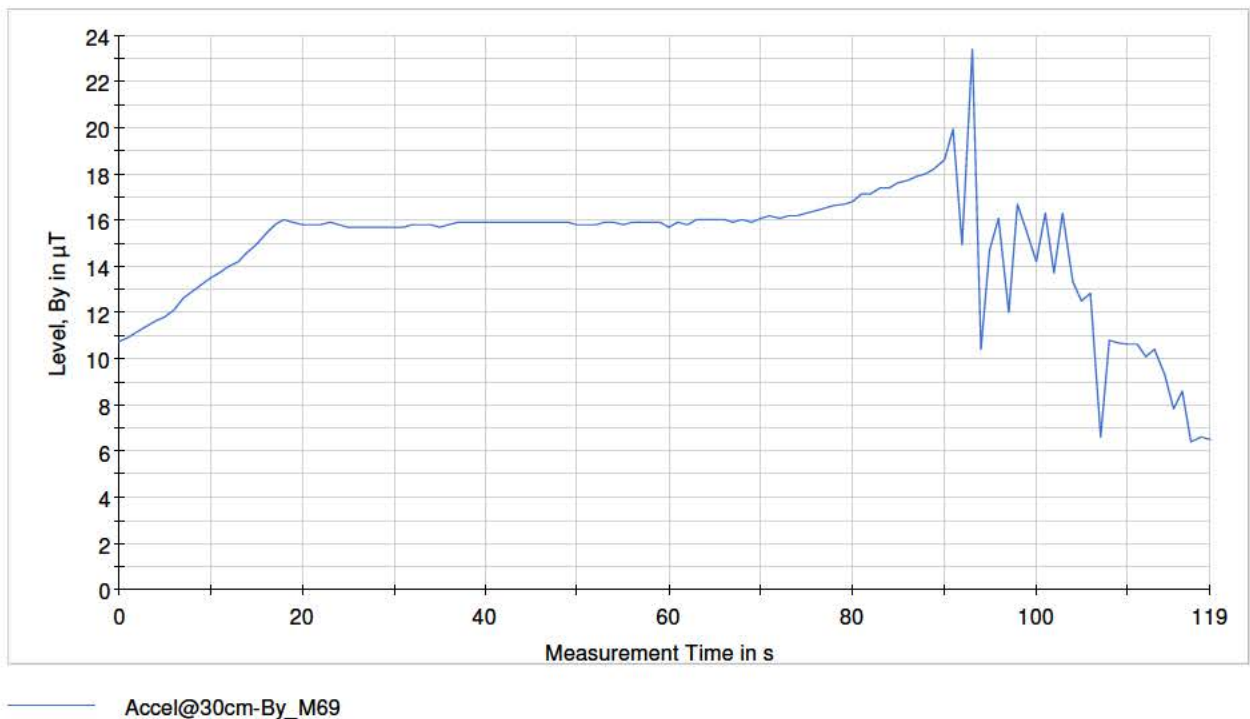

A1.16 Intercity-IC (transit), h=0.3 m., d=3 m.

Date & Time	Direction	Operating condition / Train type	Train serial #		Estimated current during test [A]		Distance to track [m]	Height - sensor [m]	Remark
			1	2	Min	Max			
2018/11/21 13:35	W => O	Intercity-IC (transit) / DDZ	7614	---	-222	-45	3	0.3	P-3, Bz-axis

Current data:

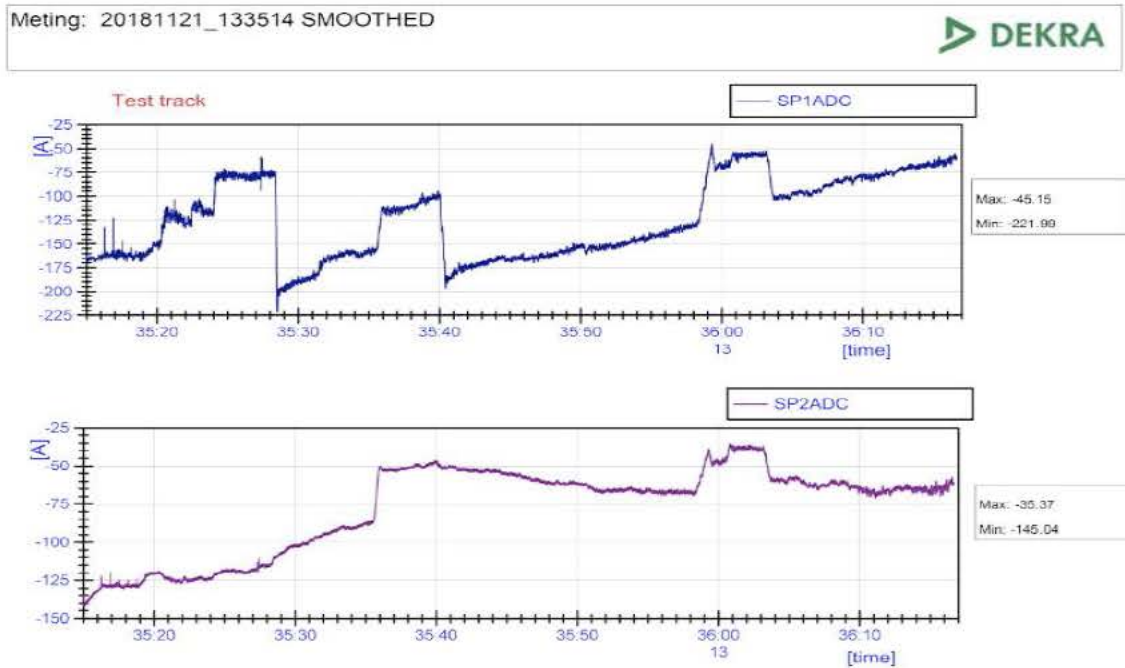

Measurement graphic:

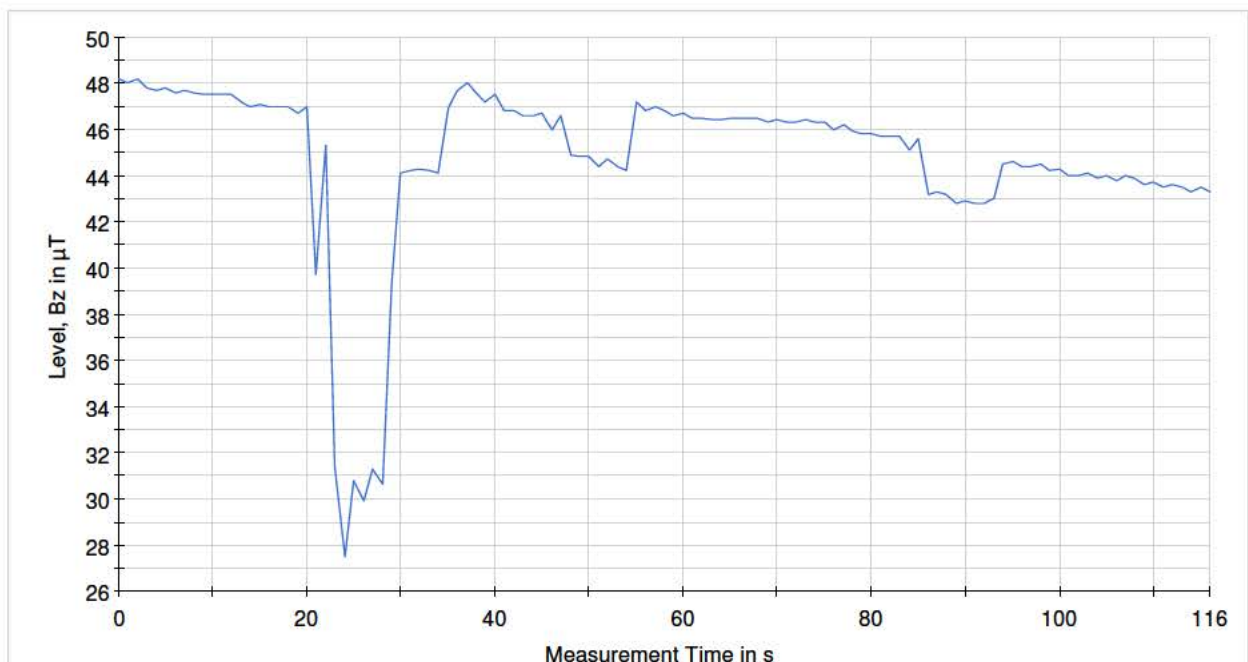

— Transit@30cm-Bz_M75

Date & Time	Direction	Operating condition / Train type	Train serial #		Estimated current during test [A]		Distance to track [m]	Height - sensor [m]	Remark
			1	2	Min	Max			
2018/11/21 15:34	W => O	Intercity-IC (transit) / DDZ	7637	---	-305	332	3	0.3	P-3, Bx-axis

Current data:

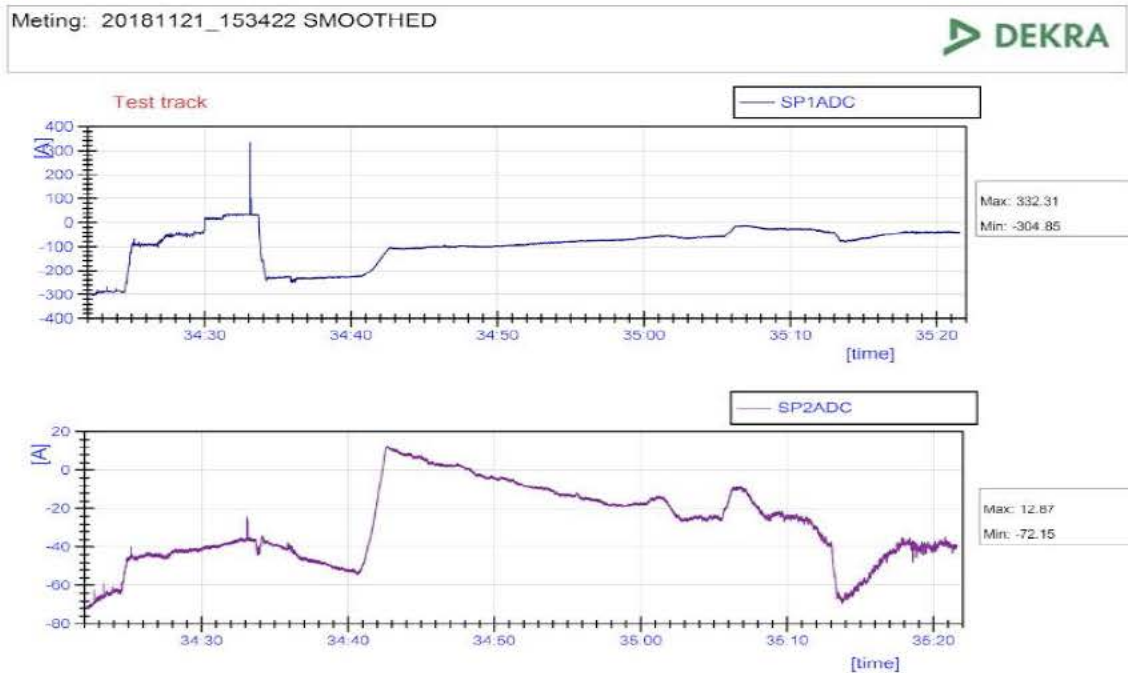

Measurement graphic:

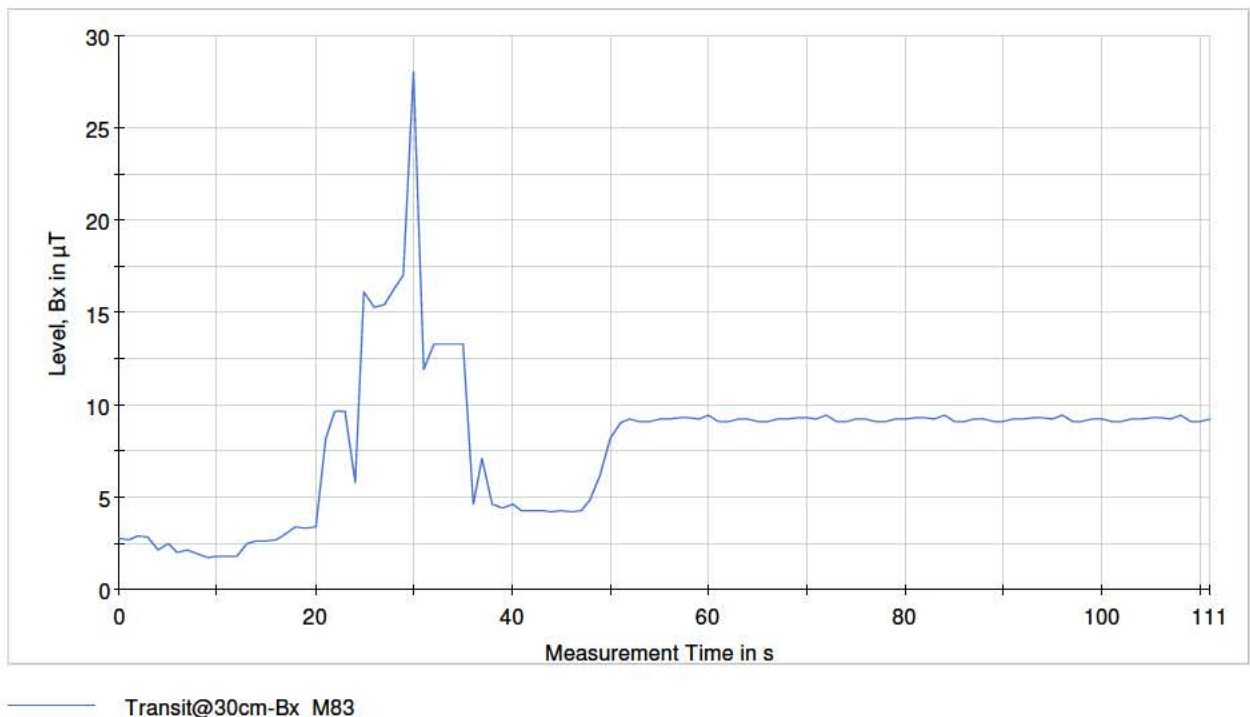

Date & Time	Direction	Operating condition / Train type	Train serial #		Estimated current during test [A]		Distance to track [m]	Height - sensor [m]	Remark
			1	2	Min	Max			
2018/11/21 15:34	W => O	Intercity-IC (transit) / VIRM	9556	---	-293	301	3	0.3	P-3, By-axis

Current data:

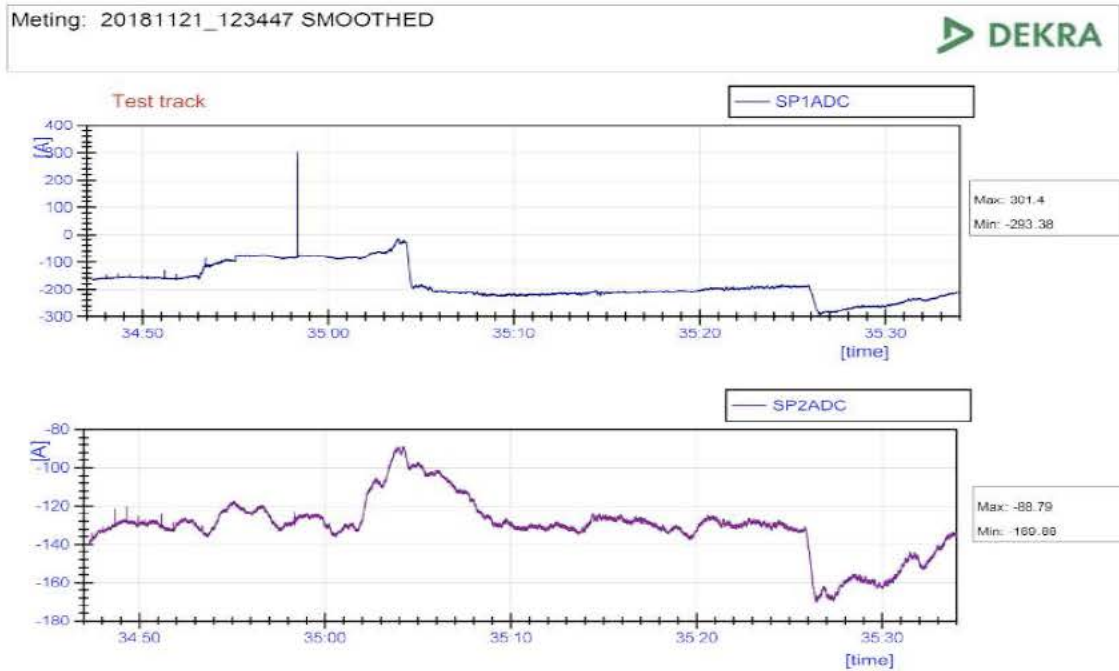

Measurement graphic:

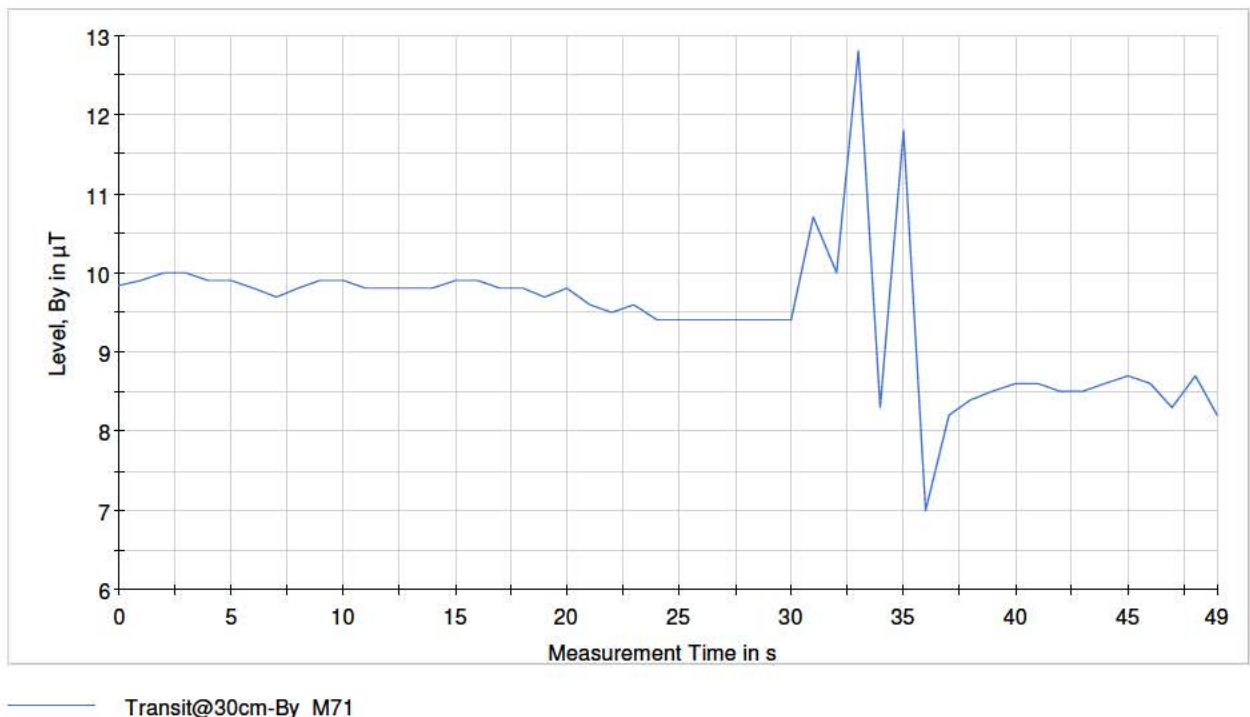

A1.17 Stoptrein (acceleration), h=1 m., d=3 m.

Date & Time	Direction	Operating condition / Train type	Train serial #		Estimated current during test [A]		Distance to track [m]	Height - sensor [m]	Remark
			1	2	Min	Max			
2018/11/21 09:47	W => O	Stoptrein (accel) / Flirt	2232	2512	-627	1045	3	1	P-3, Bz-axis

Current data:

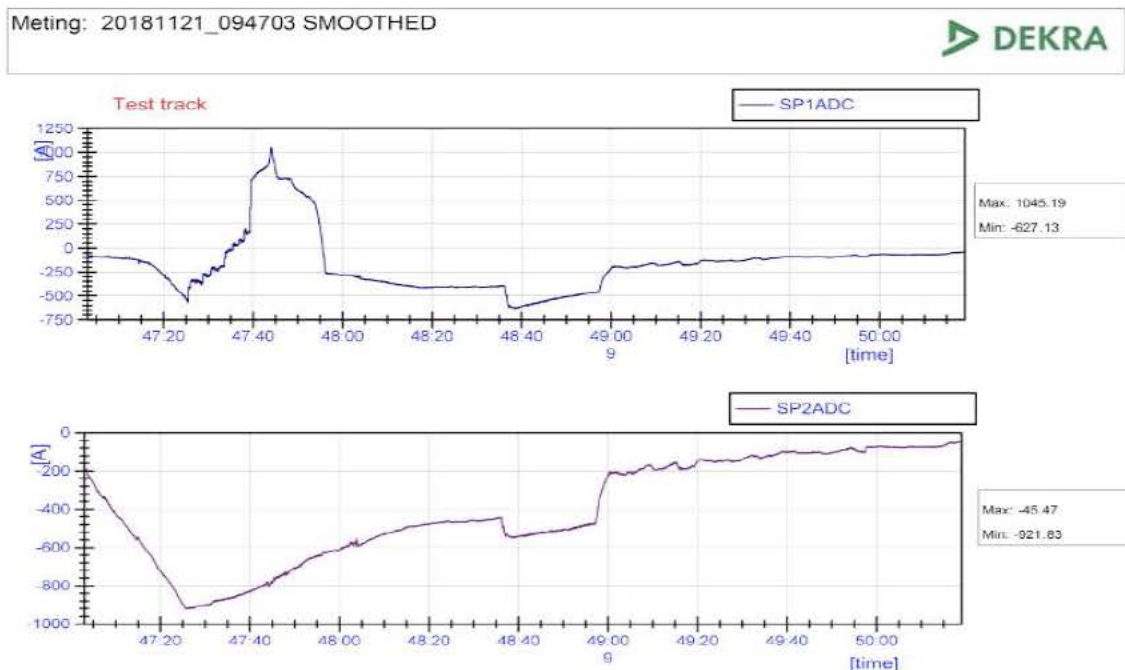

Measurement graphic:

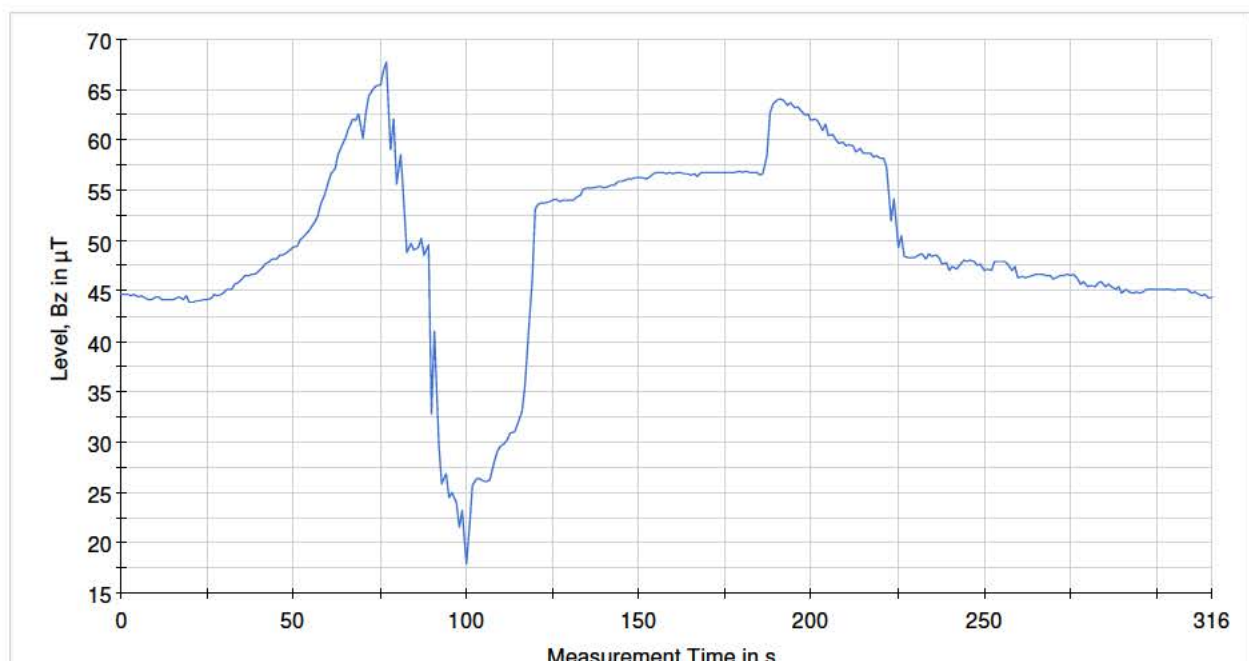

Accel@1m-Bz_M59

Date & Time	Direction	Operating condition / Train type	Train serial #		Estimated current during test [A]		Distance to track [m]	Height - sensor [m]	Remark
			1	2	Min	Max			
2018/11/21 10:49	W => O	Stoptrein (accel) / Flirt	2506	2208	-307	1476	3	1	P-3, Bx-axis, See 1)

1) Stoptrain (acceleration) on SP1ADC and barking train (stoptrain) on SP2ADC.

Current data:

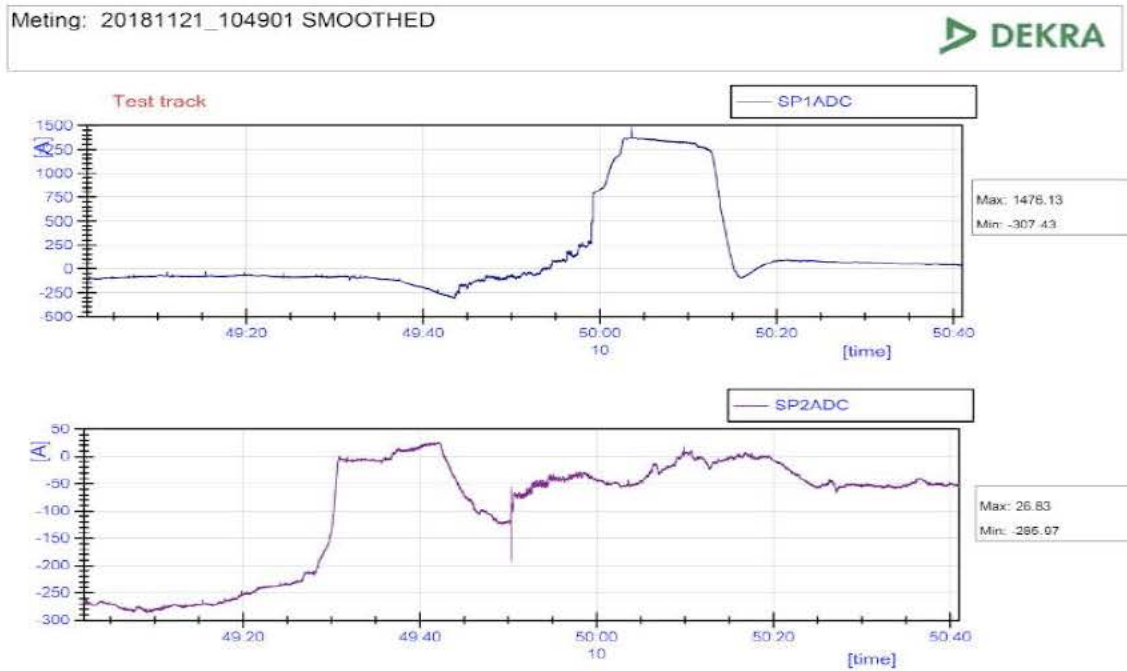

Measurement graphic:

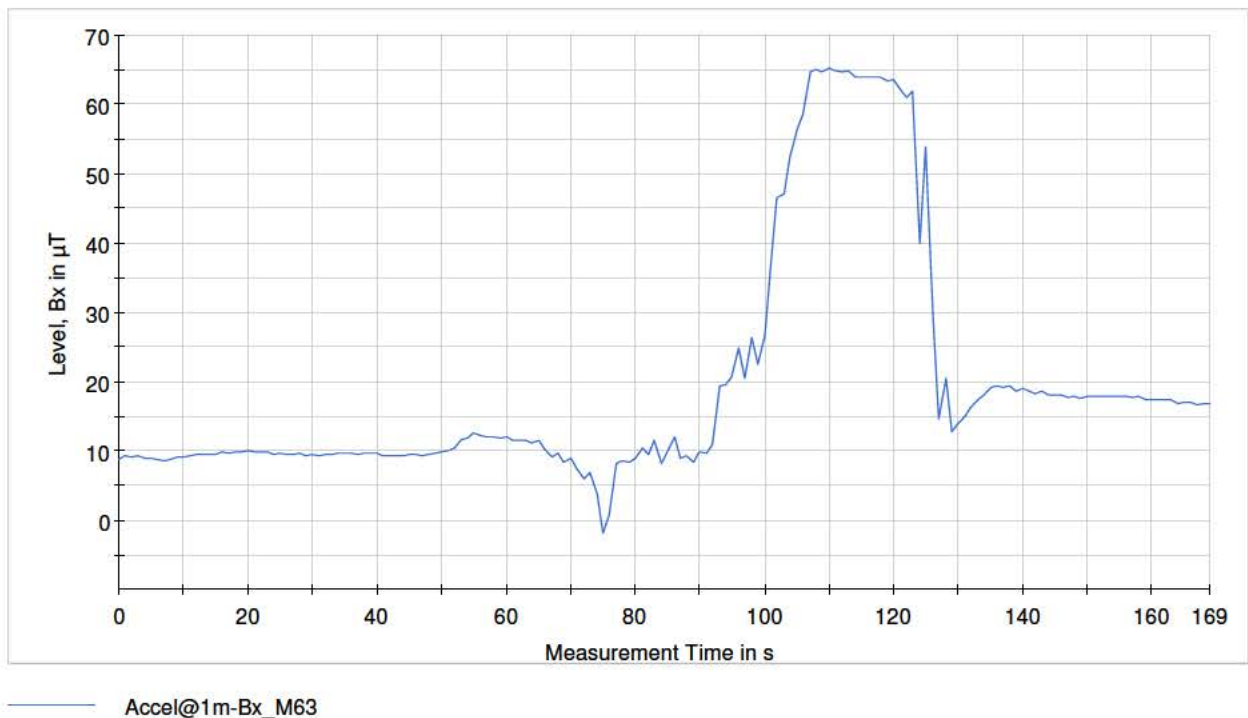

Date & Time	Direction	Operating condition / Train type	Train serial #		Estimated current during test [A]		Distance to track [m]	Height - sensor [m]	Remark
			1	2	Min	Max			
2018/11/21 11:48	W => O	Stoptrein (accel) / Flirt	2507	2224	-436	574	3	1	P-3, By-axis

Current data:

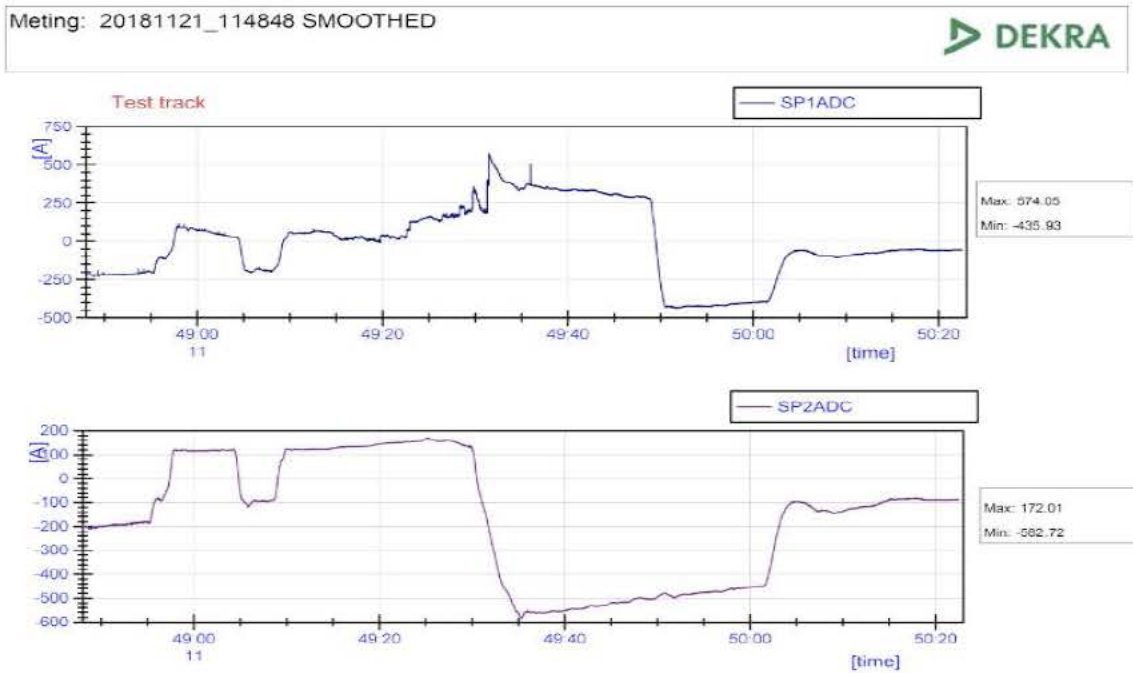

Measurement graphic:

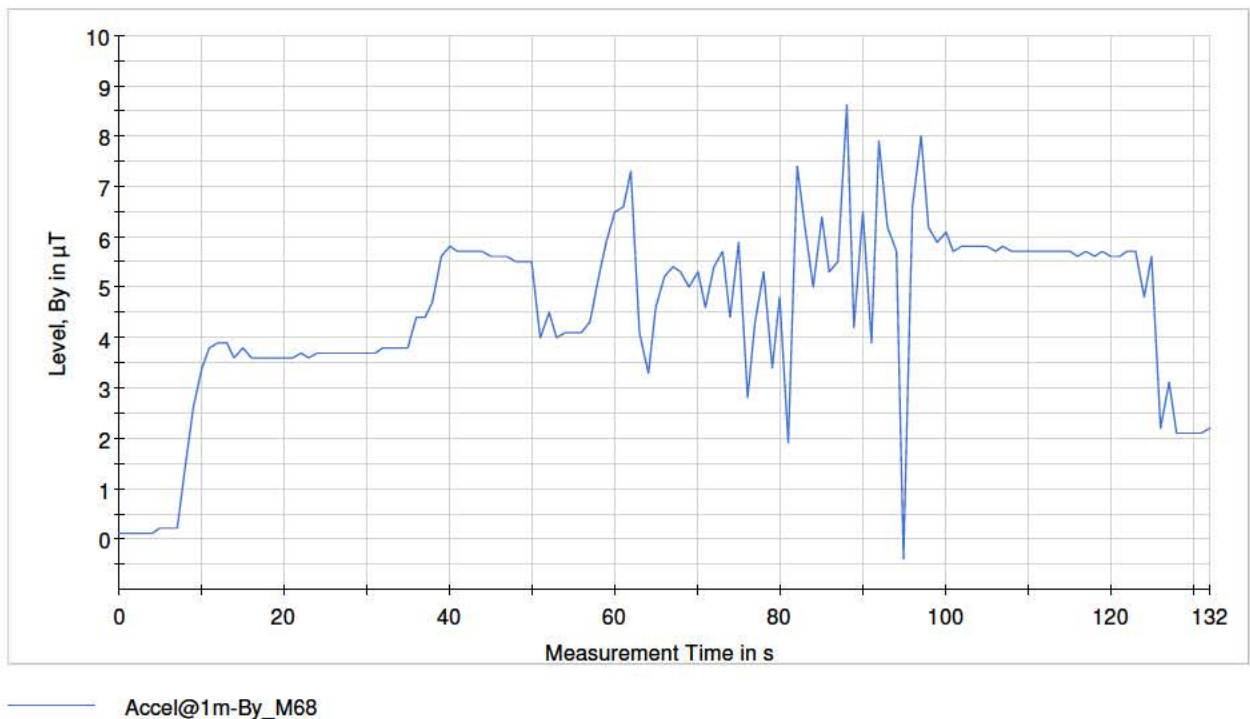

A1.18 Intercity-IC (transit), h=1 m., d=3 m.

Date & Time	Direction	Operating condition / Train type	Train serial #		Estimated current during test [A]		Distance to track [m]	Height - sensor [m]	Remark
			1	2	Min	Max			
2018/11/20 16:33	W => O	Intercity-IC (transit) / DDZ	7635	---	-368	47	3	1	P-3, Bz-axis

Current data:

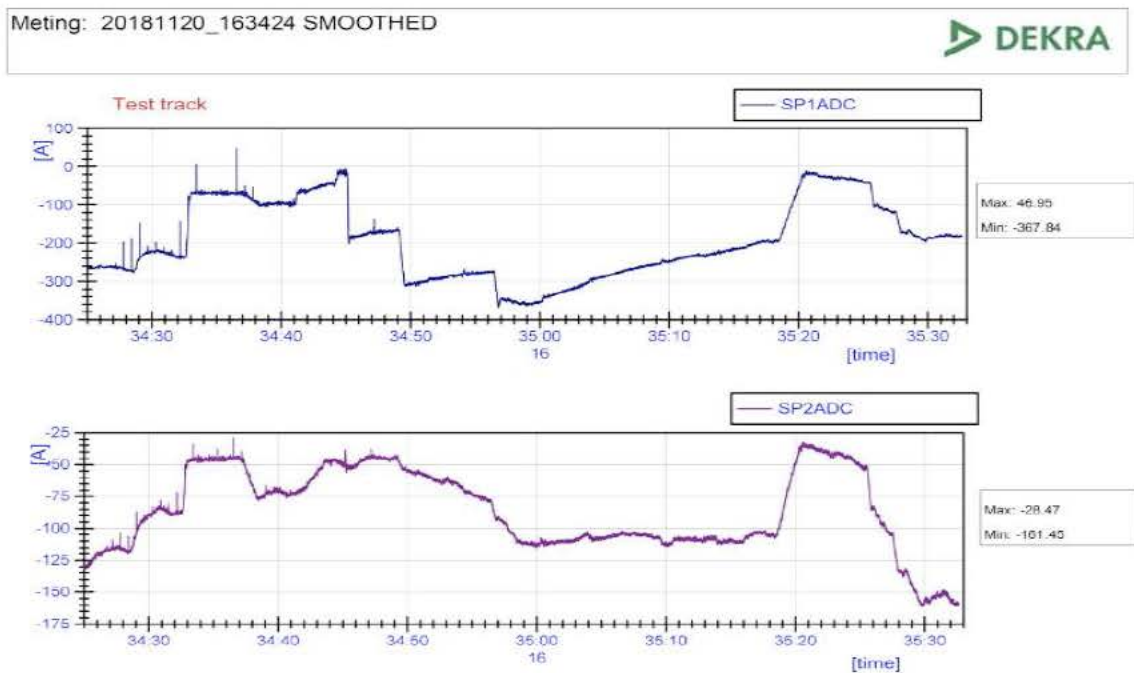

Measurement graphic:

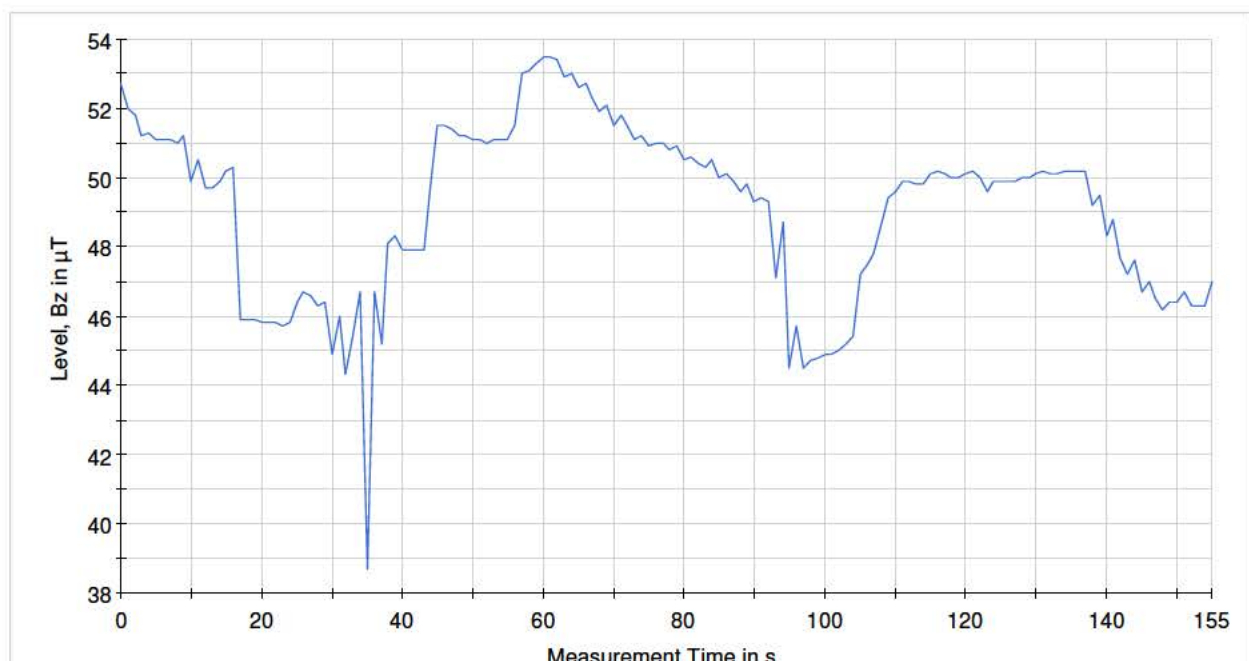

Transit@1m-Bz_M55

Date & Time	Direction	Operating condition / Train type	Train serial #		Estimated current during test [A]		Distance to track [m]	Height - sensor [m]	Remark
			1	2	Min	Max			
2018/11/21 11:05	W => O	Intercity-IC (transit) / DDZ	7609	---	-169	169	3	1	P-3, Bx-axis

Current data:

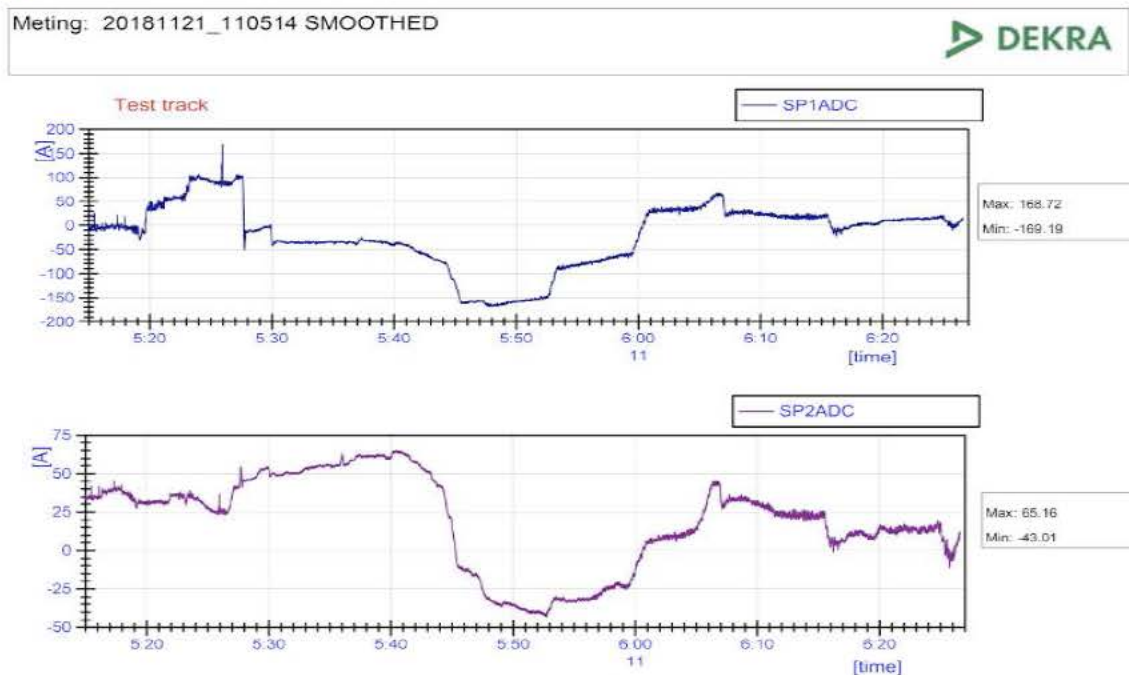

Measurement graphic:

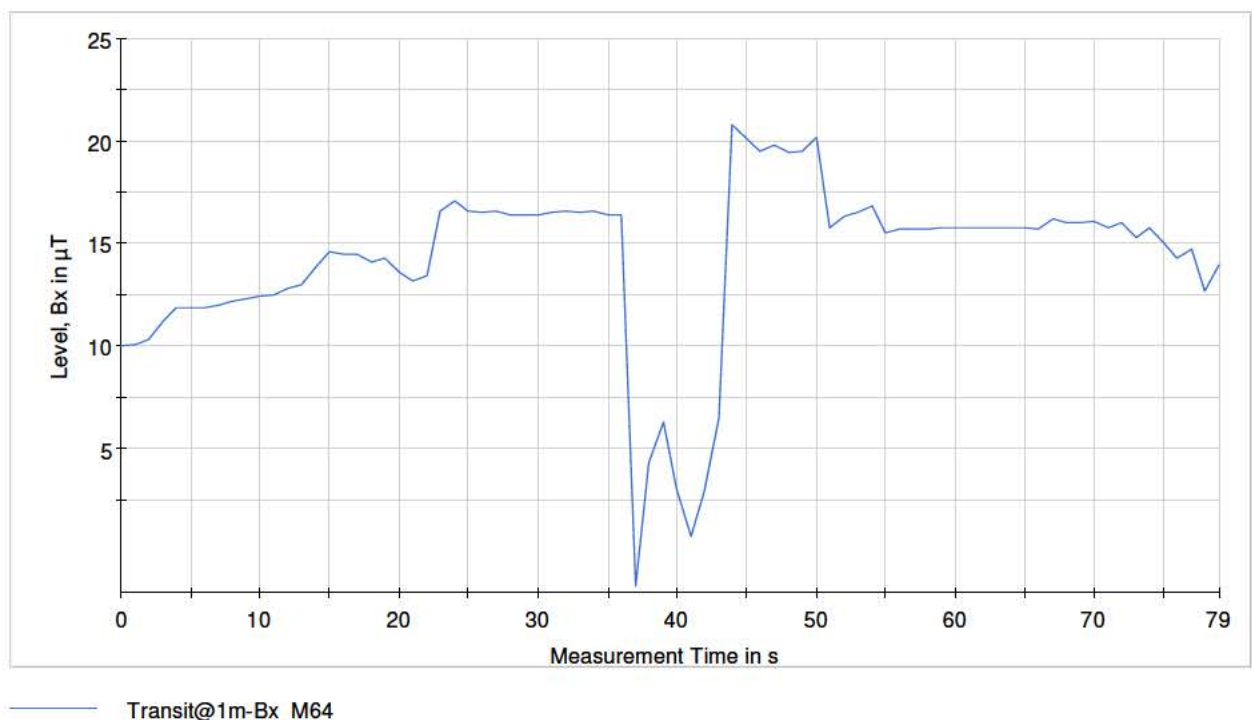

Date & Time	Direction	Operating condition / Train type	Train serial #		Estimated current during test [A]		Distance to track [m]	Height - sensor [m]	Remark
			1	2	Min	Max			
2018/11/21 11:36	W => O	Transit / DDM	1732	---	-97	146	3	1	P-3, By-axis

Current data:

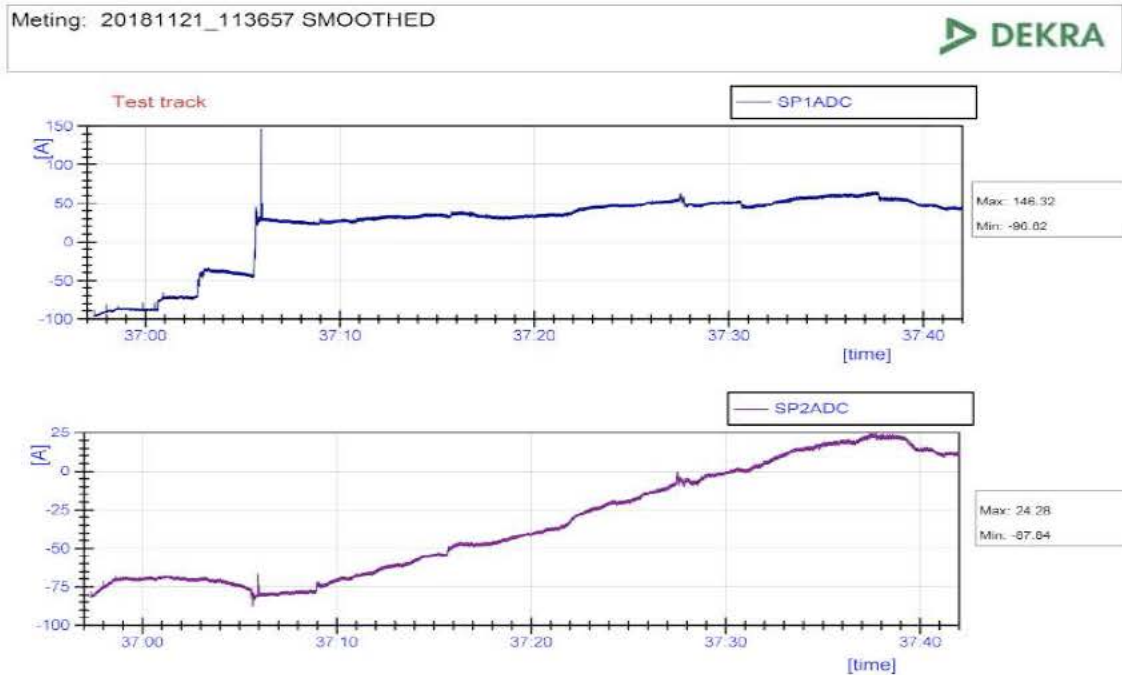

Measurement graphic:

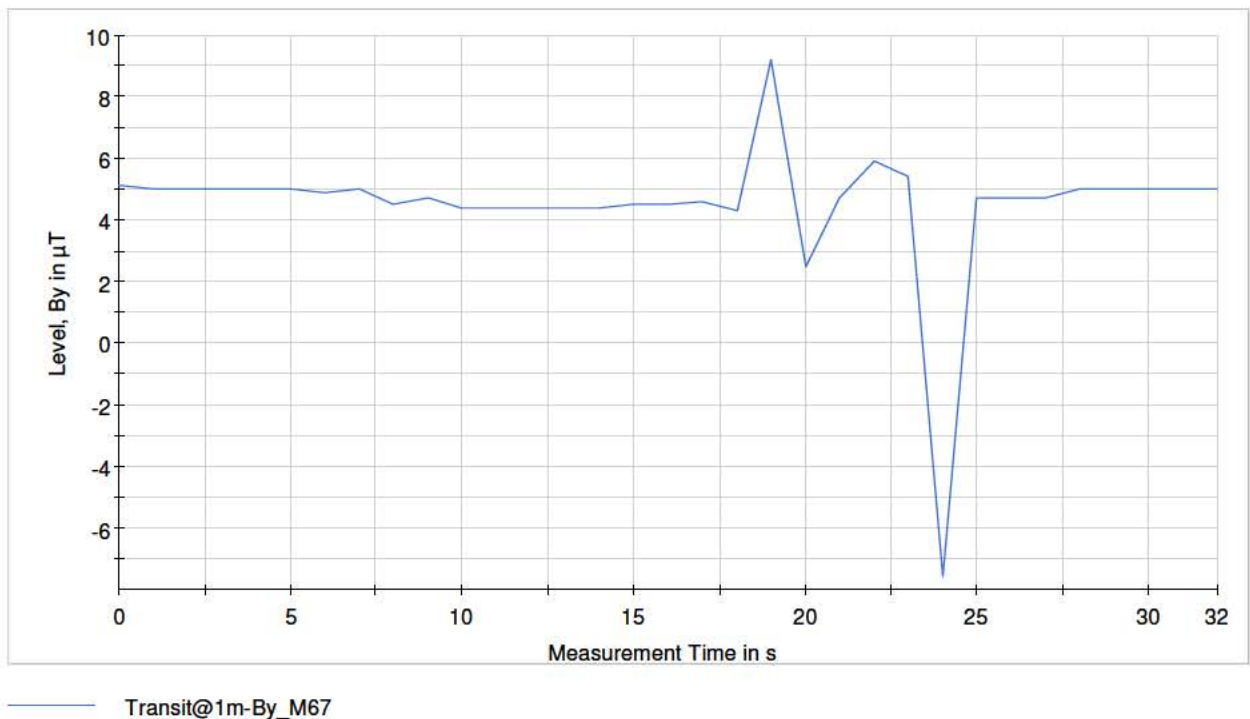

A1.19 Stoptrein (acceleration), h=0.3 m., d=6 m.

Date & Time	Direction	Operating condition / Train type	Train serial #		Estimated current during test [A]		Distance to track [m]	Height - sensor [m]	Remark
			1	2	Min	Max			
2018/11/21 17:17	W => O	Stoptrein (accel) / Flirt	2209	2510	-903	510	6	0.3	P-4, Bz-axis

Current data:



Measurement graphic:

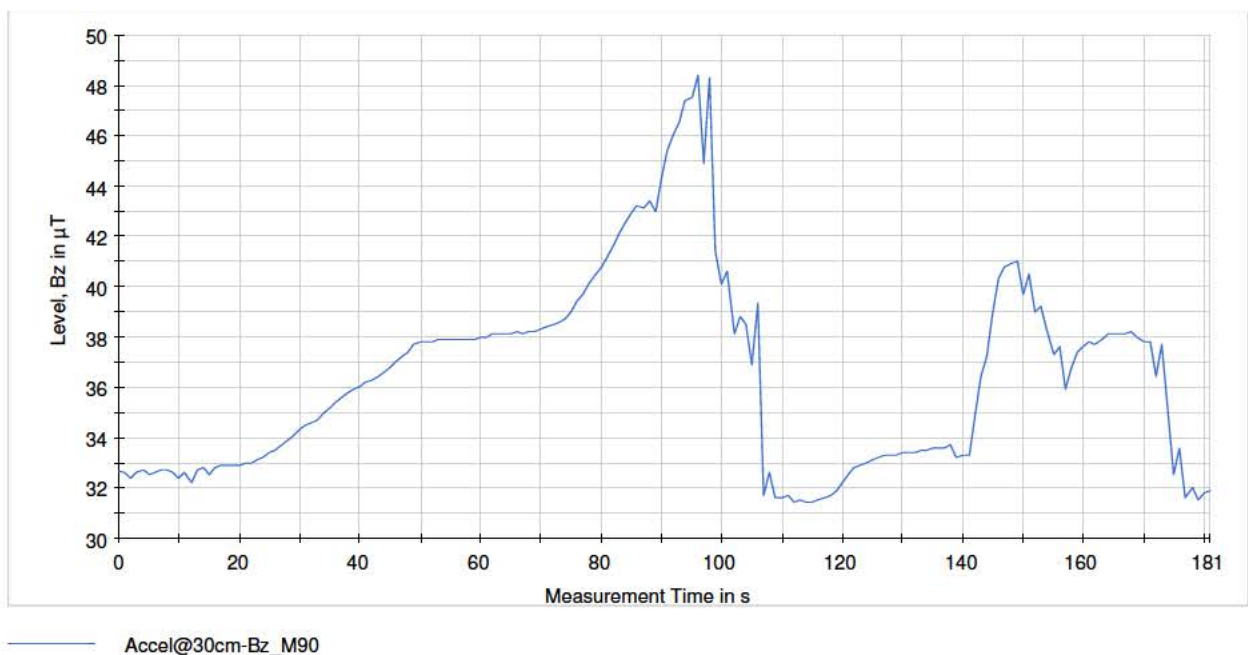

Date & Time	Direction	Operating condition / Train type	Train serial #		Estimated current during test [A]		Distance to track [m]	Height - sensor [m]	Remark
			1	2	Min	Max			
2018/11/21 18:19	W => O	Stoptrein (accel) / Flirt	2524	2210	-530	1196	6	0.3	P-4, Bz-axis

Current data:

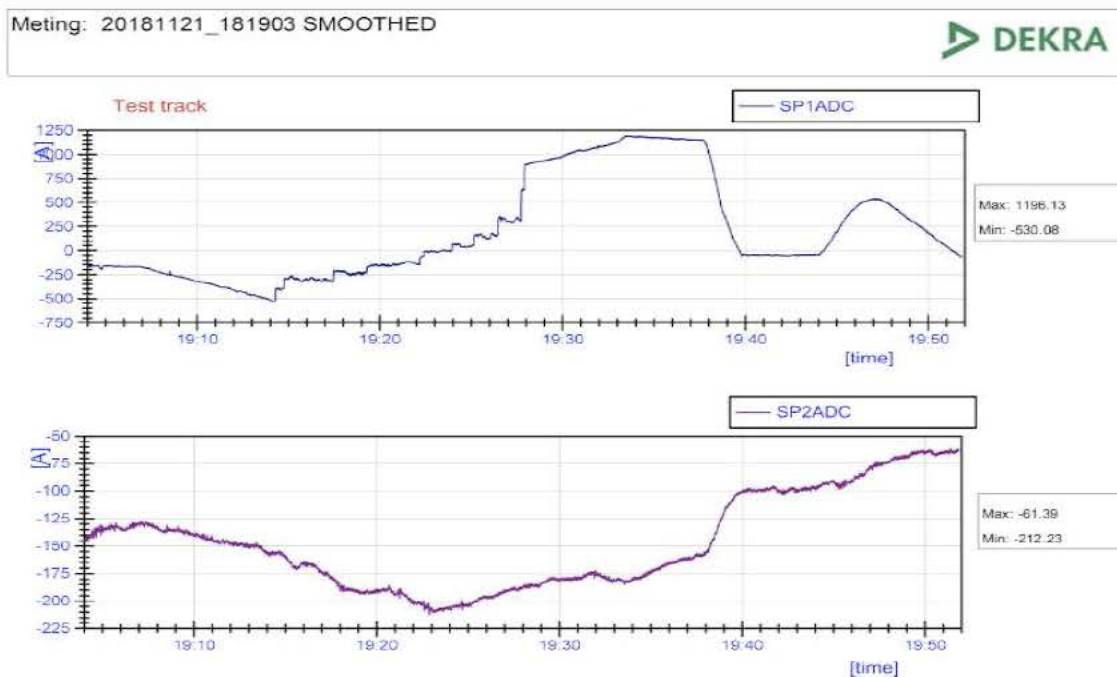

Measurement graphic:

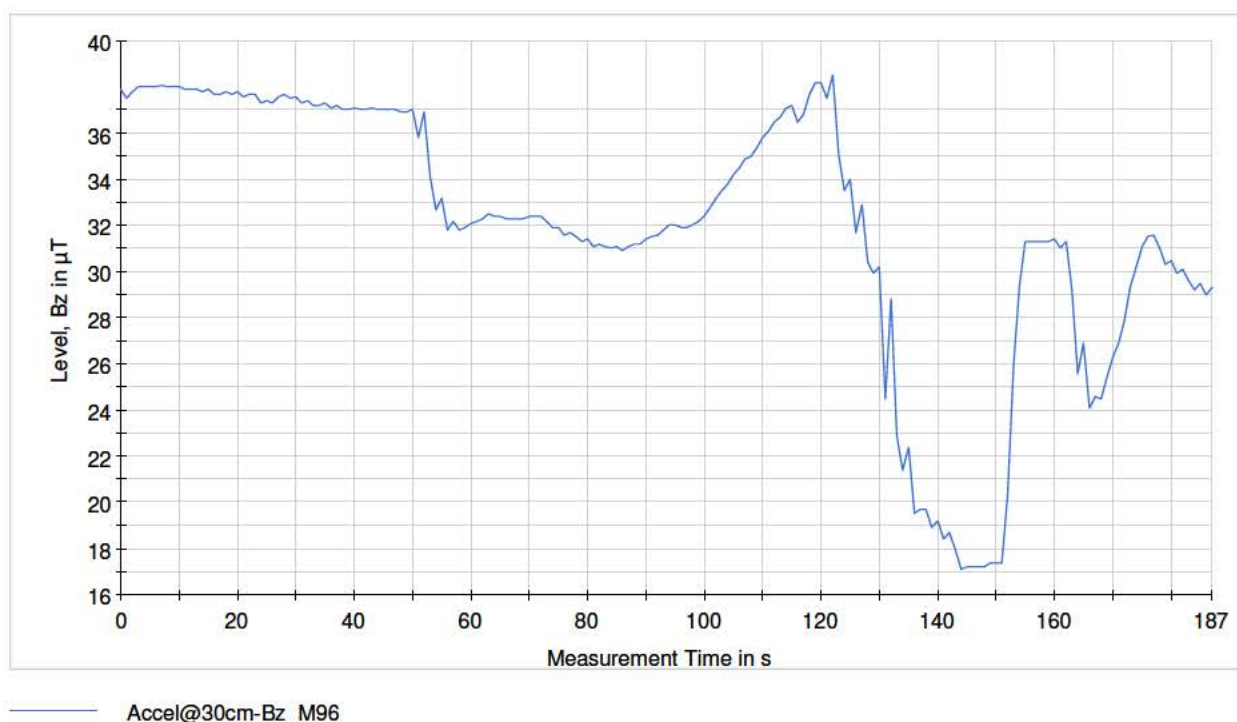

Date & Time	Direction	Operating condition / Train type	Train serial #		Estimated current during test [A]		Distance to track [m]	Height - sensor [m]	Remark
			1	2	Min	Max			
2018/11/21 16:17	W => O	Stoptrein (accel) / Flirt	2508	2215	-1043	726	6	0.3	P-4, Bx-axis

Current data:

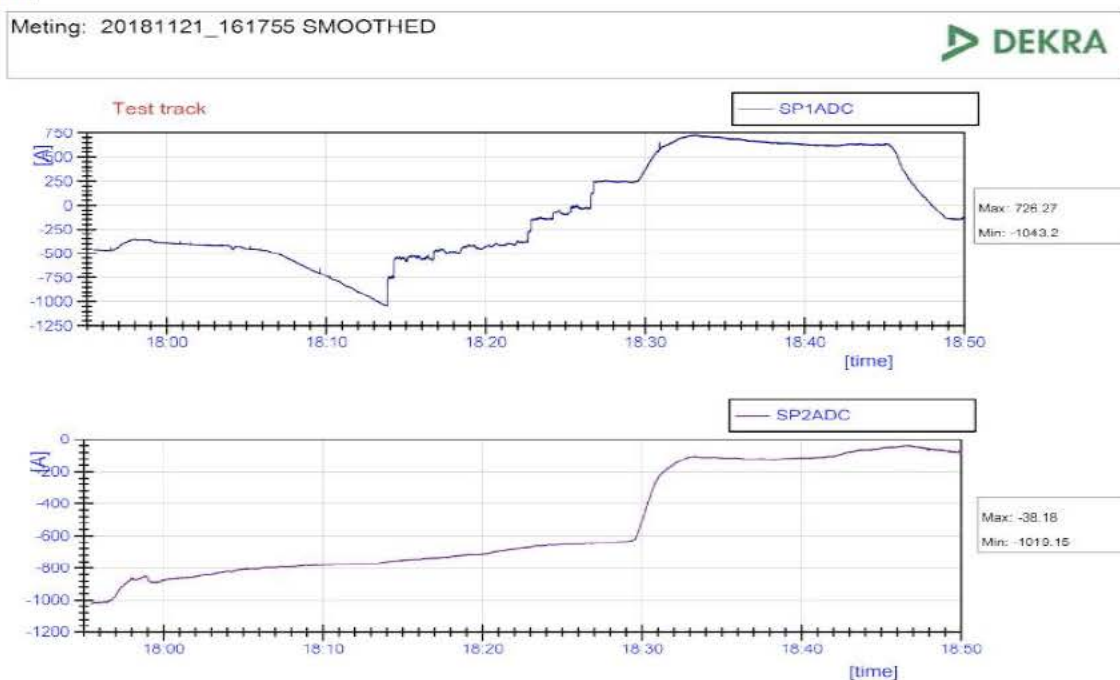

Measurement graphic:

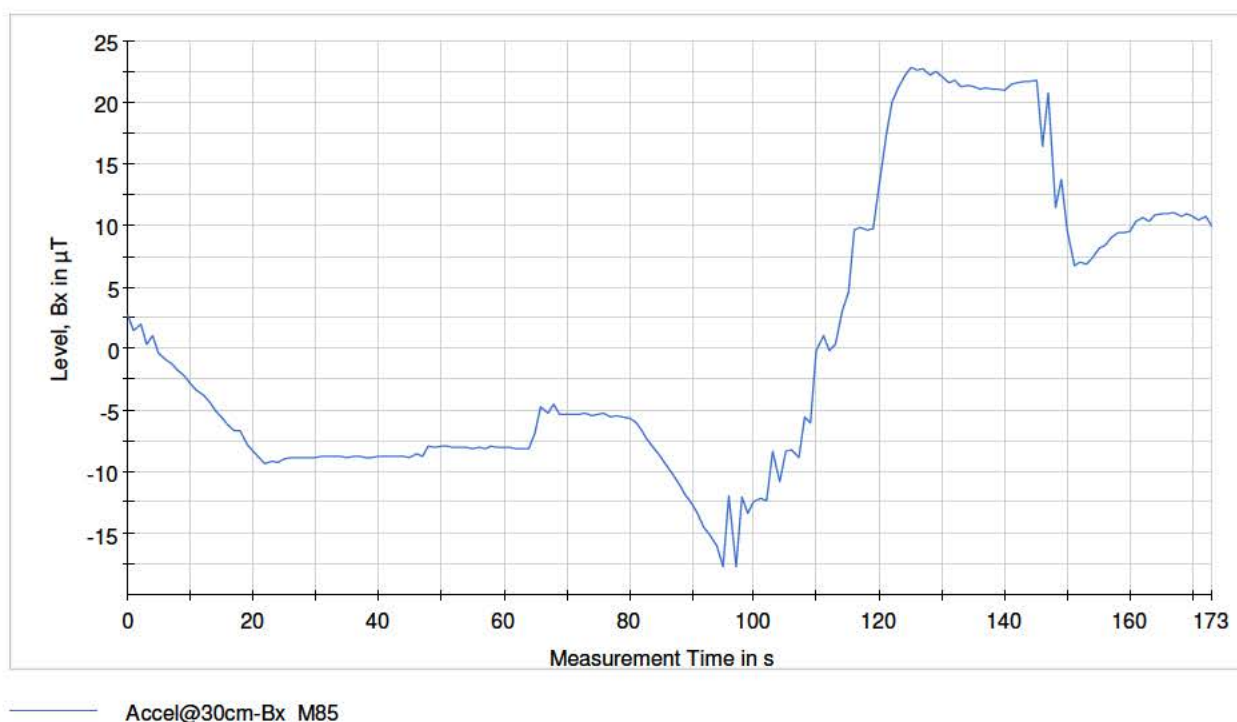

A1.20 Intercity-IC (transit), h=0.3 m., d=6 m.

Date & Time	Direction	Operating condition / Train type	Train serial #		Estimated current during test [A]		Distance to track [m]	Height - sensor [m]	Remark
			1	2	Min	Max			
2018/11/21 18:10	W => O	Transit / Diesellocc + onderhouds- machine	V100	---	-840	-196	6	0.3	P-4, Bz-axis

Current data:



Measurement graphic:

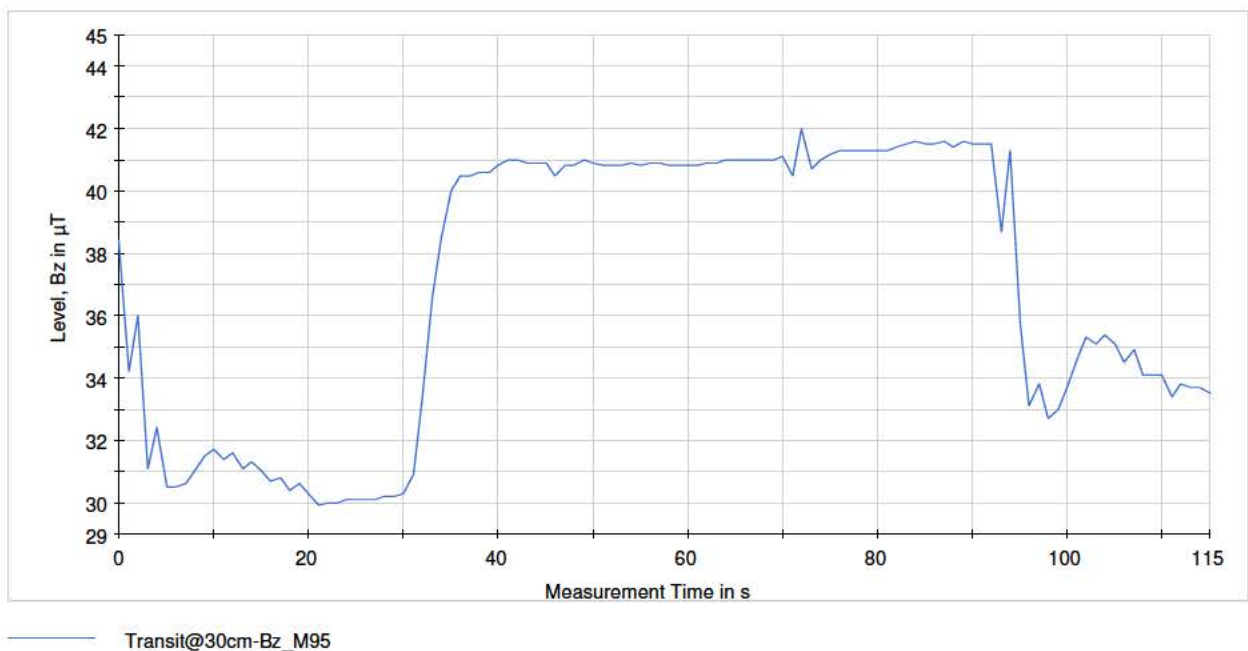

Date & Time	Direction	Operating condition / Train type	Train serial #		Estimated current during test [A]		Distance to track [m]	Height - sensor [m]	Remark
			1	2	Min	Max			
2018/11/21 17:04	W => O	Intercity-IC (transit) / DDZ	7609	---	-183	156	6	0.3	P-4, Bx-axis

Current data:

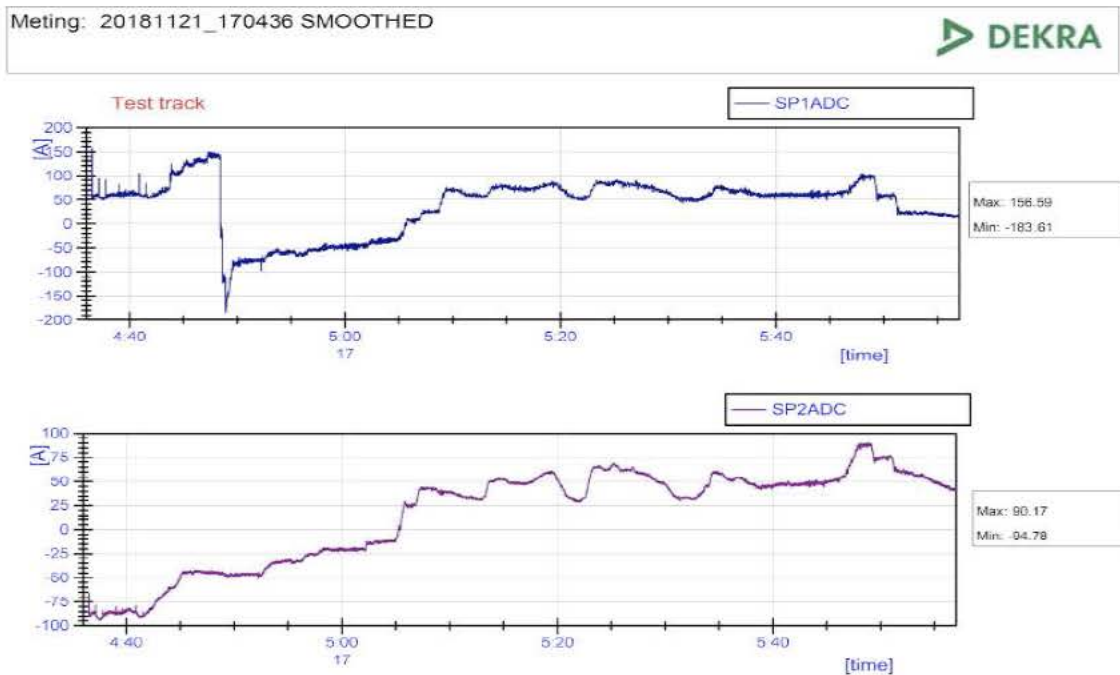

Measurement graphic:

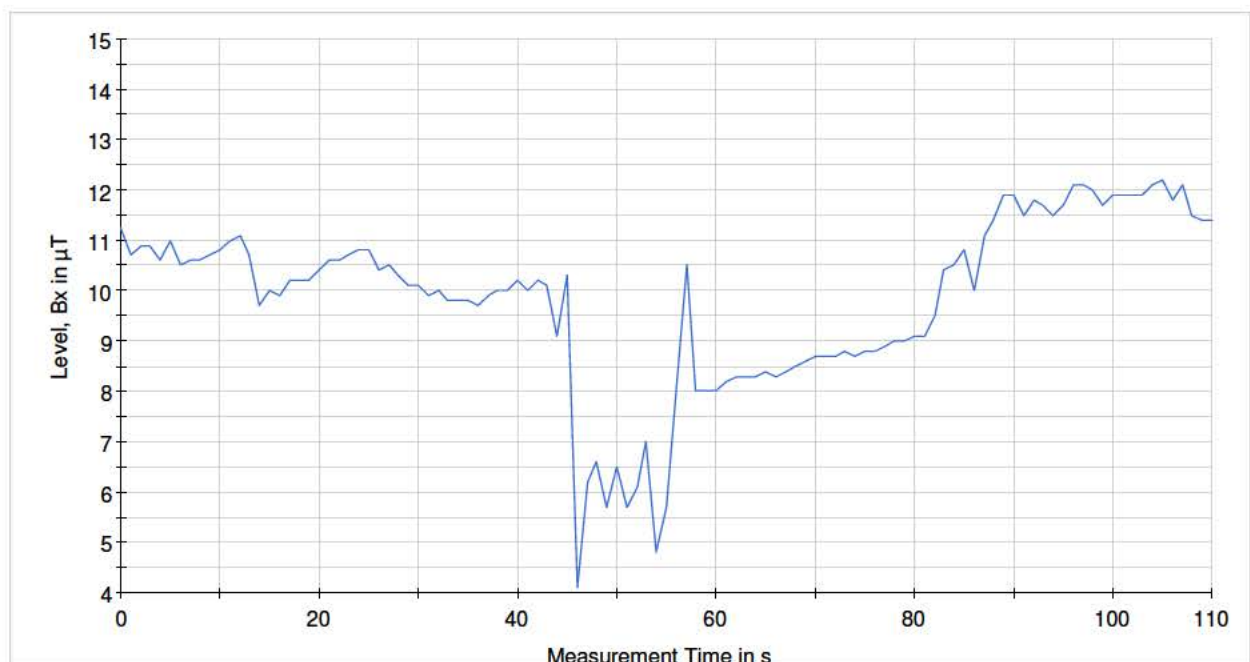

Transit@30cm-Bx_M89

A1.21 Stoptrein (acceleration), h=1 m., d=6 m.

Date & Time	Direction	Operating condition / Train type	Train serial #		Estimated current during test [A]		Distance to track [m]	Height - sensor [m]	Remark
			1	2	Min	Max			
2018/11/21 19:17	W => O	Stoptrein (accel) / Flirt	2222	2525	-534	827	6	1	P-4, Bz-axis

Current data:

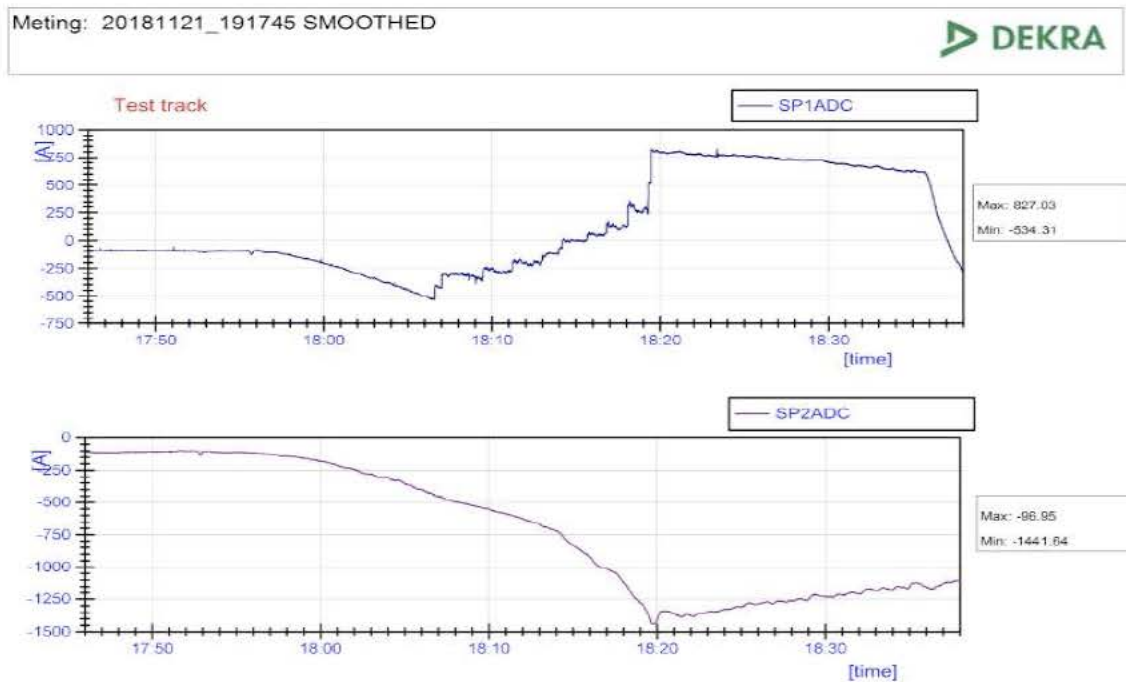

Measurement graphic:

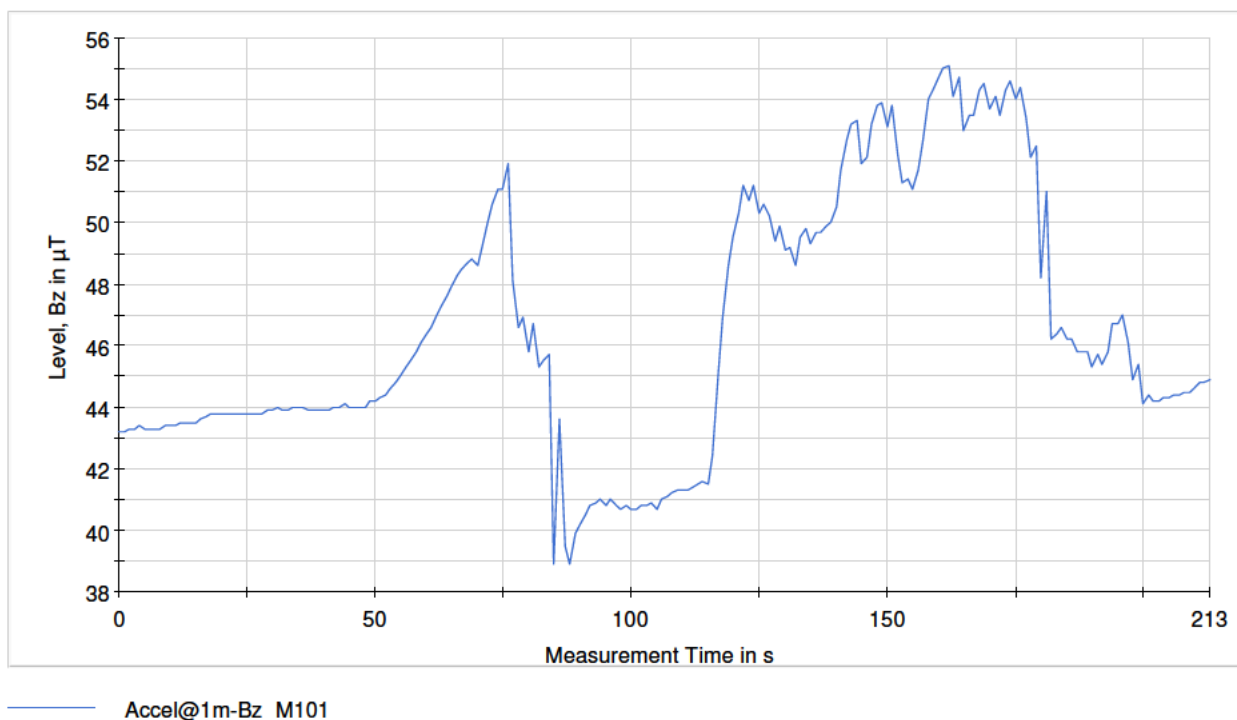

Date & Time	Direction	Operating condition / Train type	Train serial #		Estimated current during test [A]		Distance to track [m]	Height - sensor [m]	Remark
			1	2	Min	Max			
2018/11/23 10:27	W => O	Stoptrein (accel) / Flirt	2211	2228	-448	1529	6	1	P-4, Bx-axis, See 1)

1) Stoptrain (acceleration) on SP1ADC and transit train on SP2ADC.

Current data:

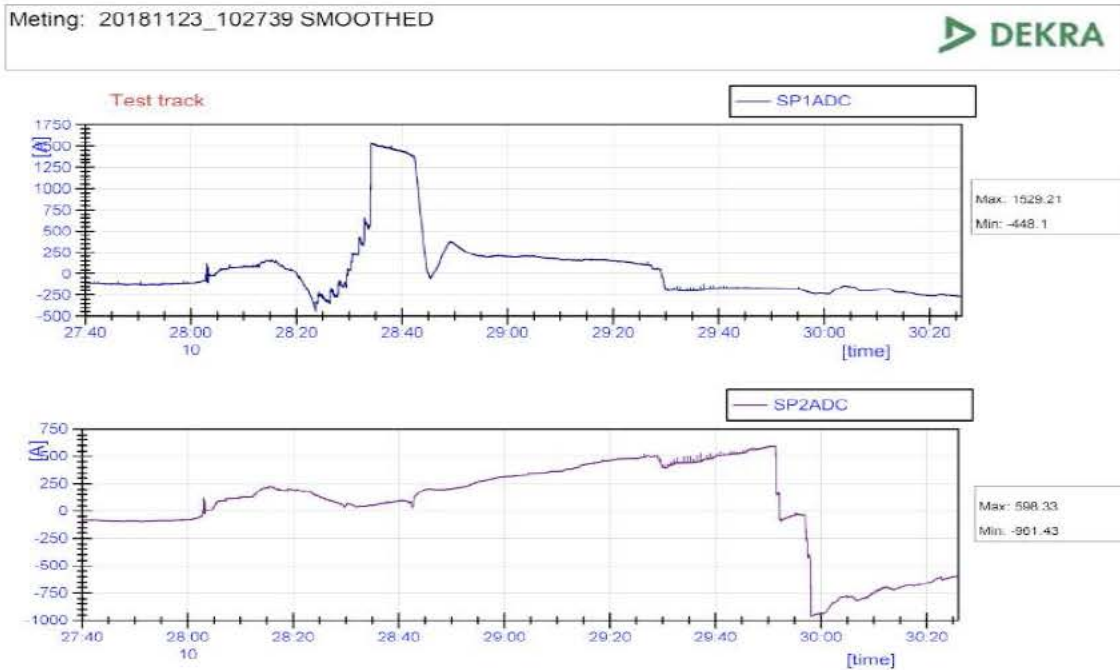

Measurement graphic:

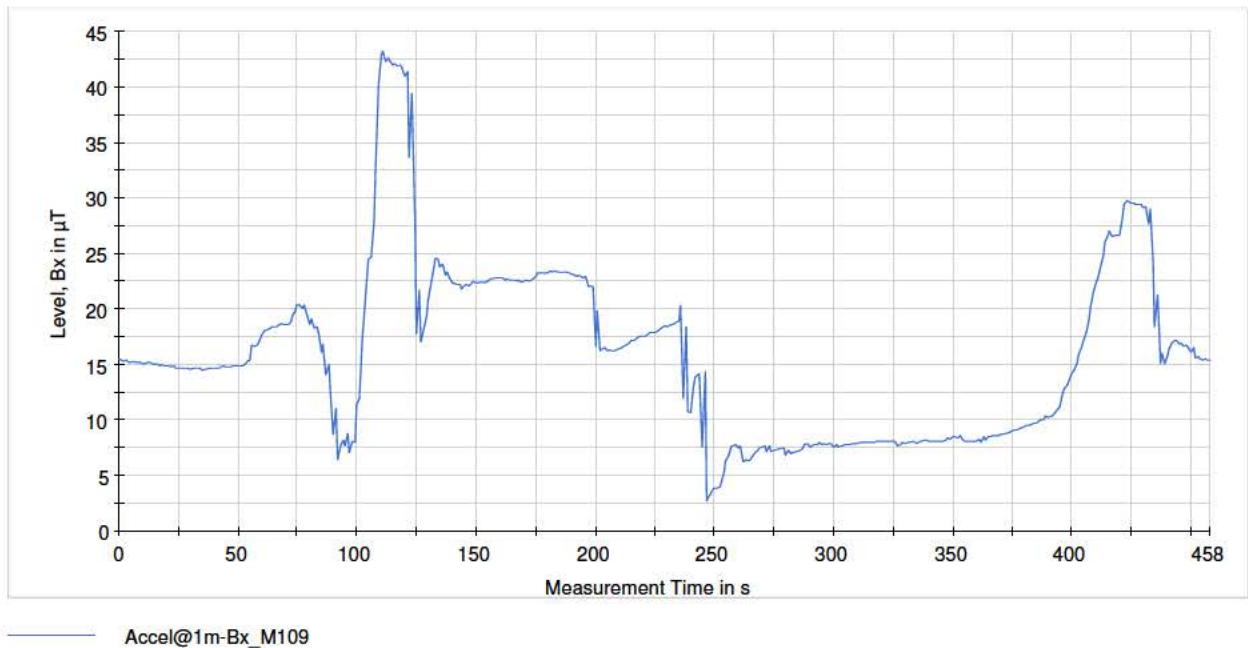

Date & Time	Direction	Operating condition / Train type	Train serial #		Estimated current during test [A]		Distance to track [m]	Height - sensor [m]	Remark
			1	2	Min	Max			
2018/11/23 11:17	W => O	Stoptrein (accel) / Flirt	2213	2515	-962	649	6	1	P-4, By-axis

Current data:



Measurement graphic:

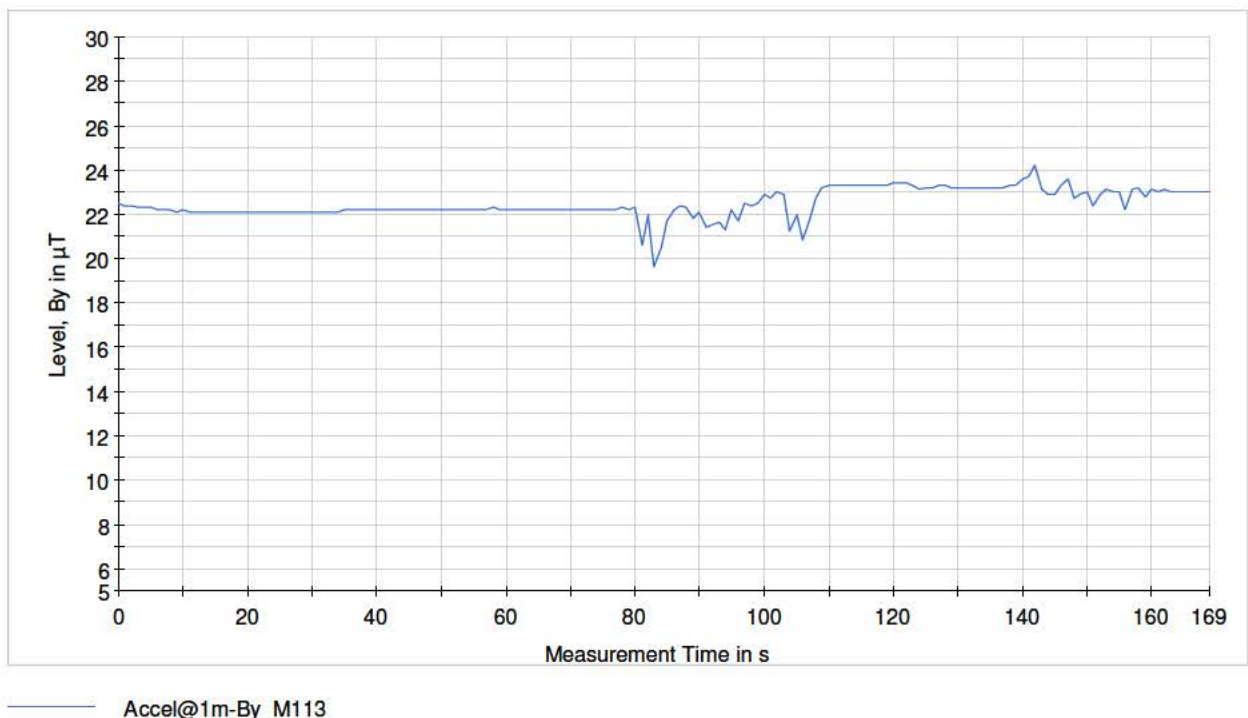

A1.22 Intercity-IC (transit), h=1 m., d=6 m.

Date & Time	Direction	Operating condition / Train type	Train serial #		Estimated current during test [A]		Distance to track [m]	Height - sensor [m]	Remark
			1	2	Min	Max			
2018/11/23 09:05	W => O	Intercity-IC (transit) / DDZ	7521	7646	-379	74	6	1	P-4, Bz-axis

Current data:

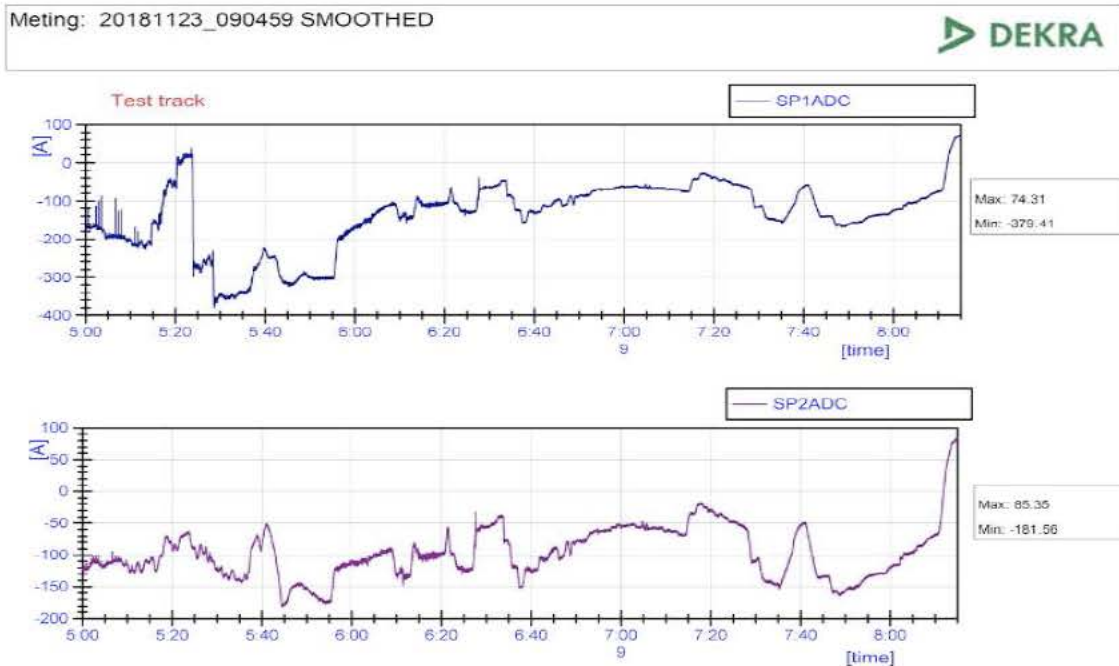

Measurement graphic:

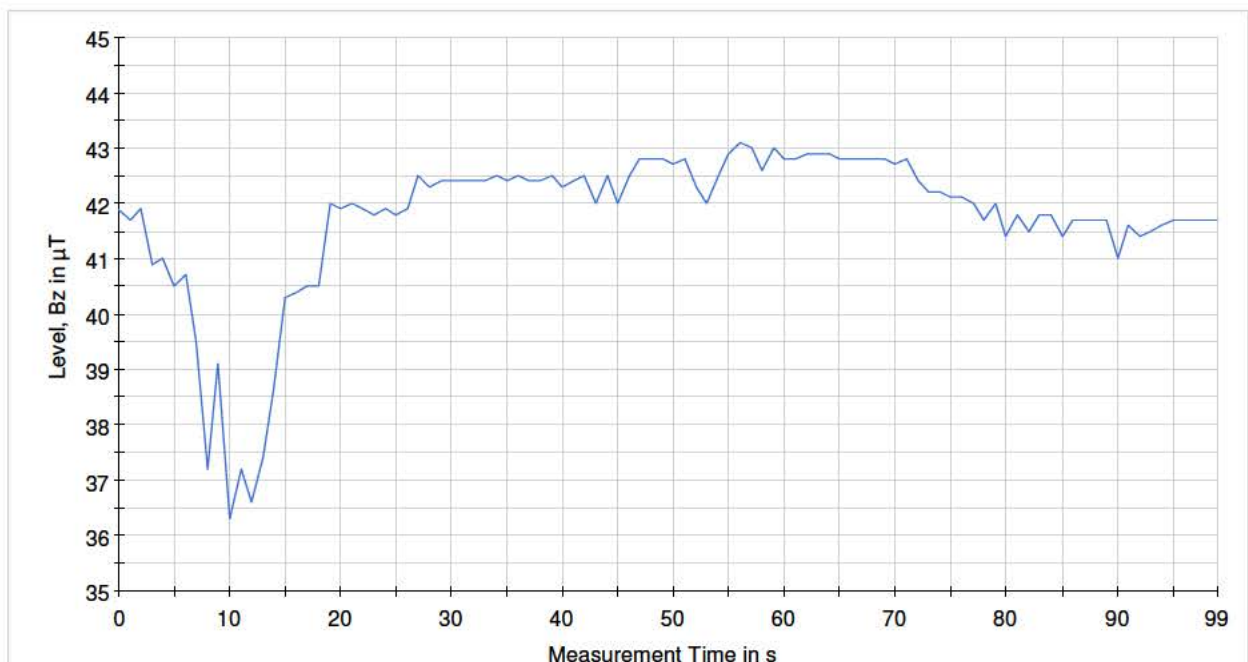

— Transit@1m-Bz_M104

Date & Time	Direction	Operating condition / Train type	Train serial #		Estimated current during test [A]		Distance to track [m]	Height - sensor [m]	Remark
			1	2	Min	Max			
2018/11/23 10:03	W => O	Intercity-IC (transit) / DDZ	7511	---	-150	150	6	1	P-4, Bx-axis

Current data:

No current data available.

Measurement graphic:

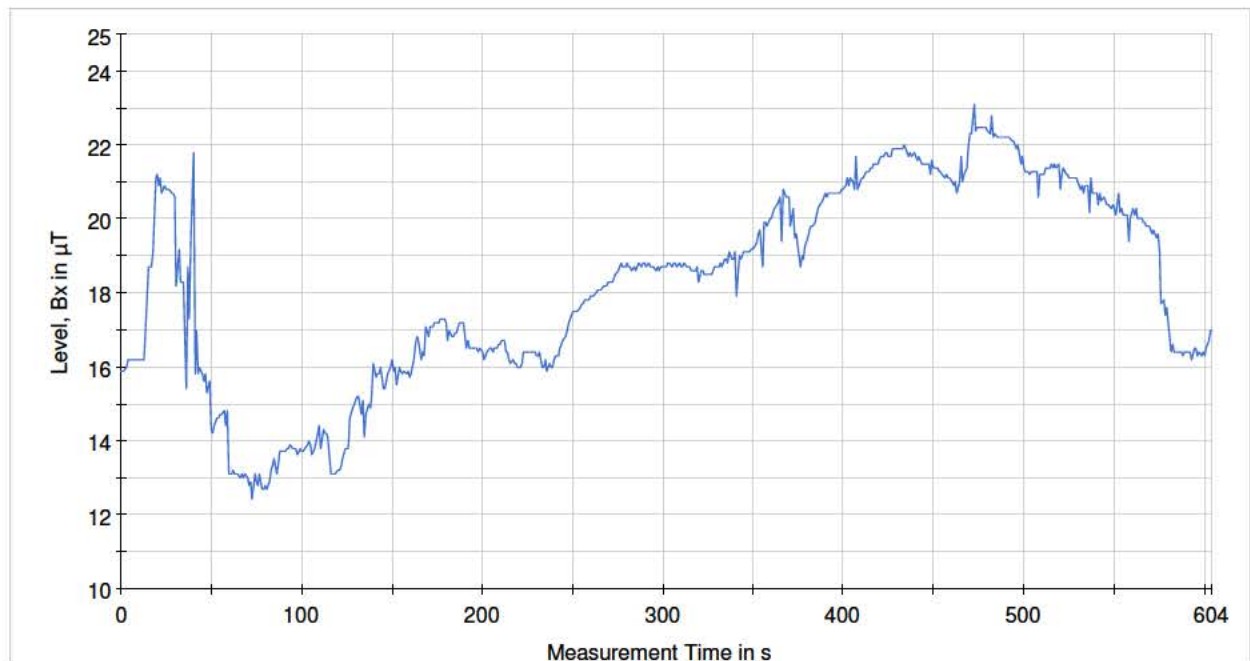

— Transit@1m-Bx_M108

Date & Time	Direction	Operating condition / Train type	Train serial #		Estimated current during test [A]		Distance to track [m]	Height - sensor [m]	Remark
			1	2	Min	Max			
2018/11/23 12:05	W => O	Intercity-IC (transit) / ICM	4063	4245	-665	262	6	1	P-4, By-axis

Current data:

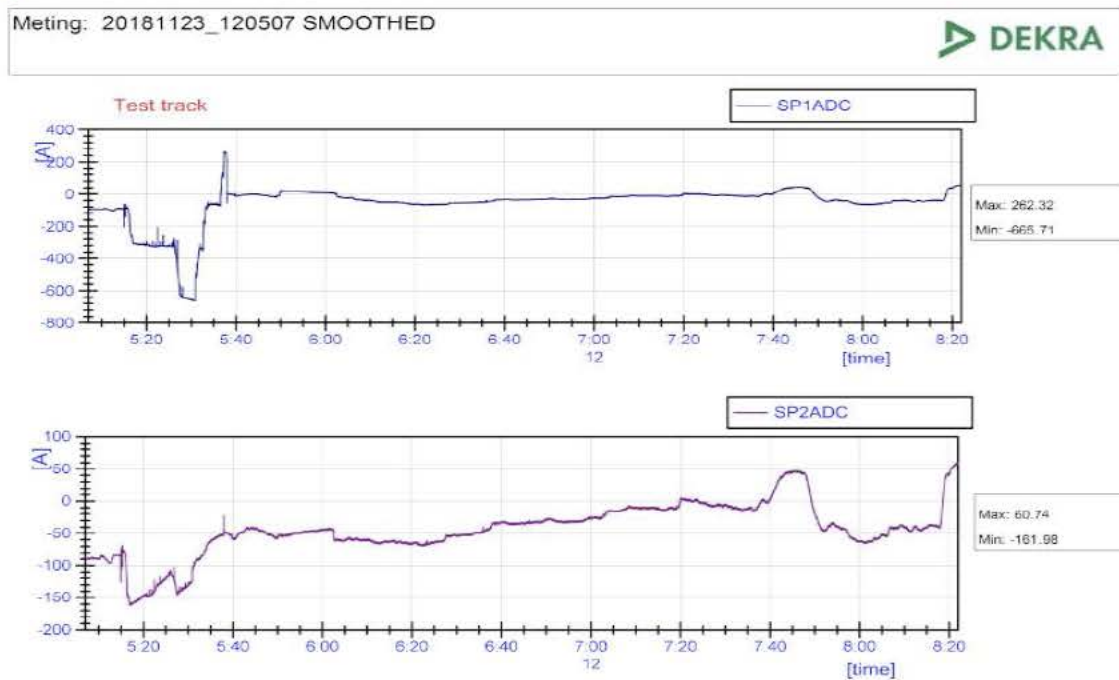

Measurement graphic:

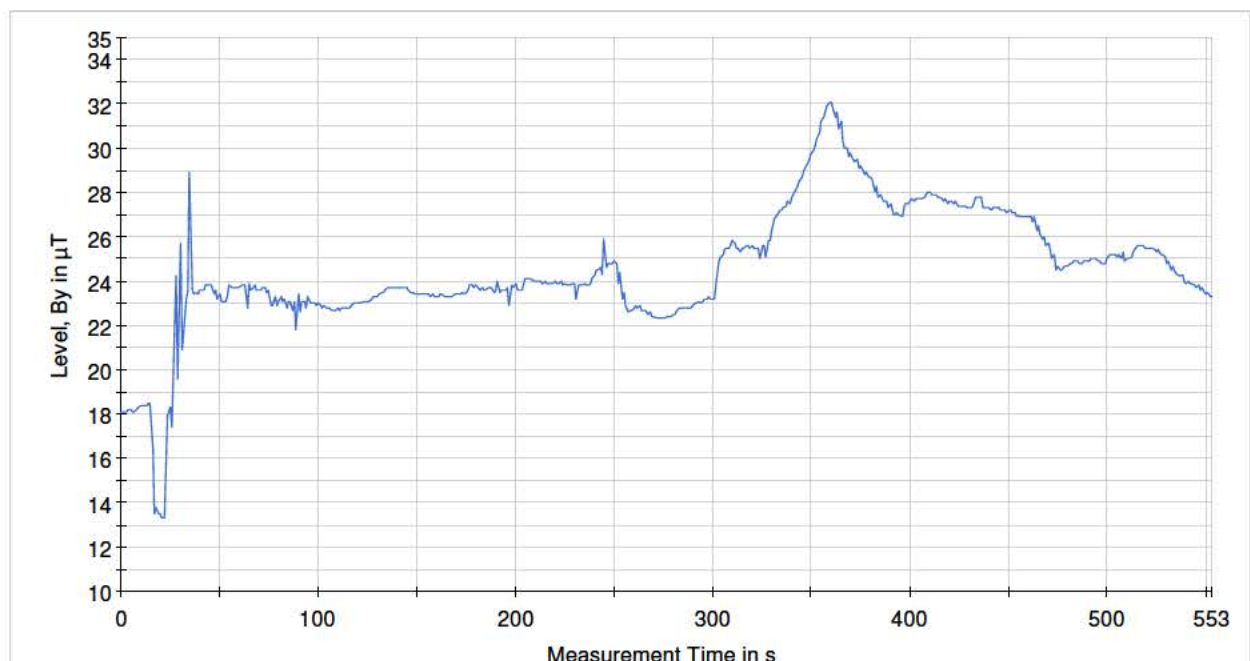

Transit@1m-By_M114

A1.23 Braking (@SP2ADC), h=1 m., d=6 m.

Date & Time	Direction	Operating condition / Train type	Train serial #		Estimated current during test [A]		Distance to track [m]	Height - sensor [m]	Remark
			1	2	Min	Max			
2018/11/23 11:17	O => W	Braking (@SP2ADC) / ---	---	2515	-1415	-42	6	1	P-4, By-axis, See 1)

1) Braking train on SP2ADC.

Current data:



Measurement graphic:

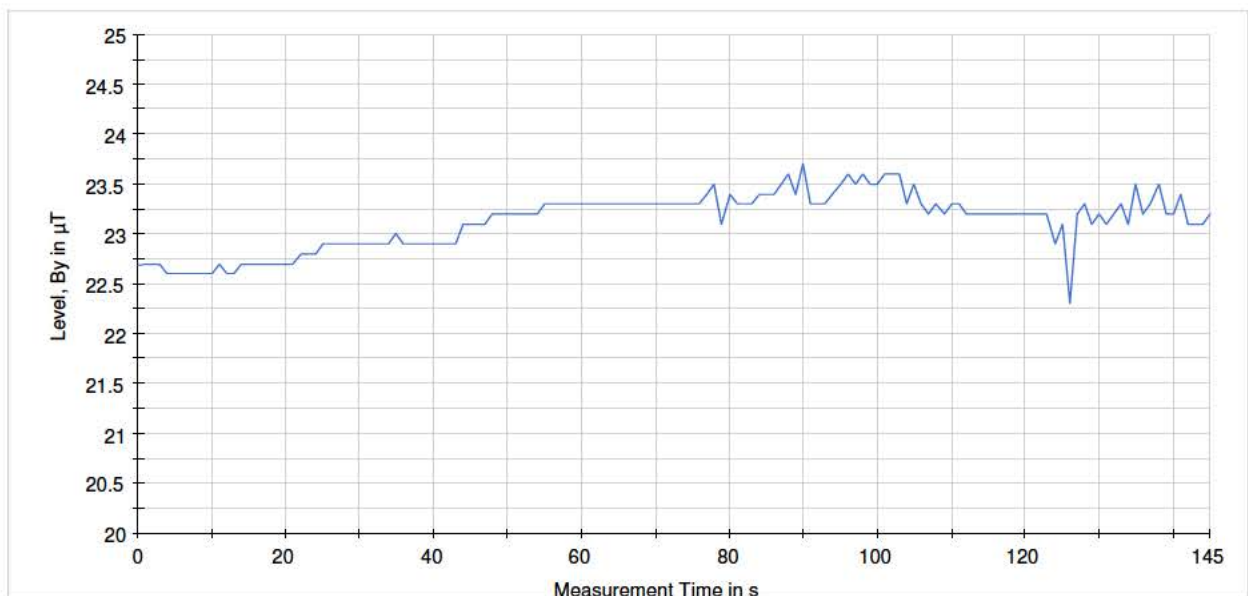

Braking-SP2ADC@1m-By_M112

A1.24 Stoptrein (acceleration), h=1 m., d=10 m.

Date & Time	Direction	Operating condition / Train type	Train serial #		Estimated current during test [A]		Distance to track [m]	Height - sensor [m]	Remark
			1	2	Min	Max			
2018/11/23 17:28	W => O	Stoptrein (accel) / Flirt	2220	2519	-1441	-46	10	1	P-5, Bz-axis

Current data:

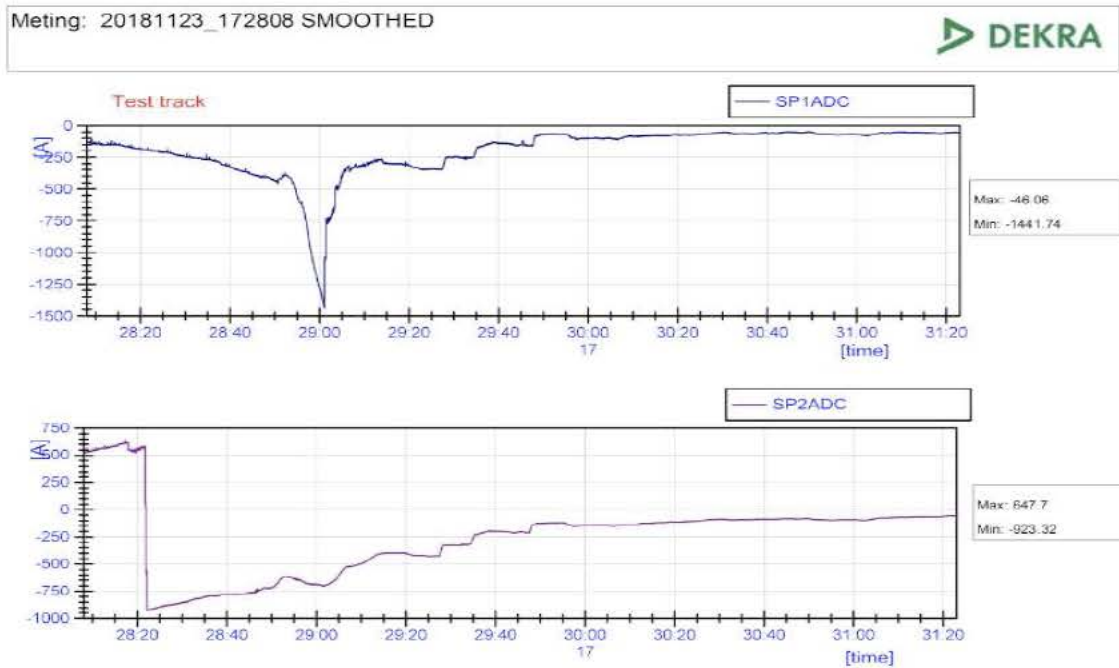

Measurement graphic:

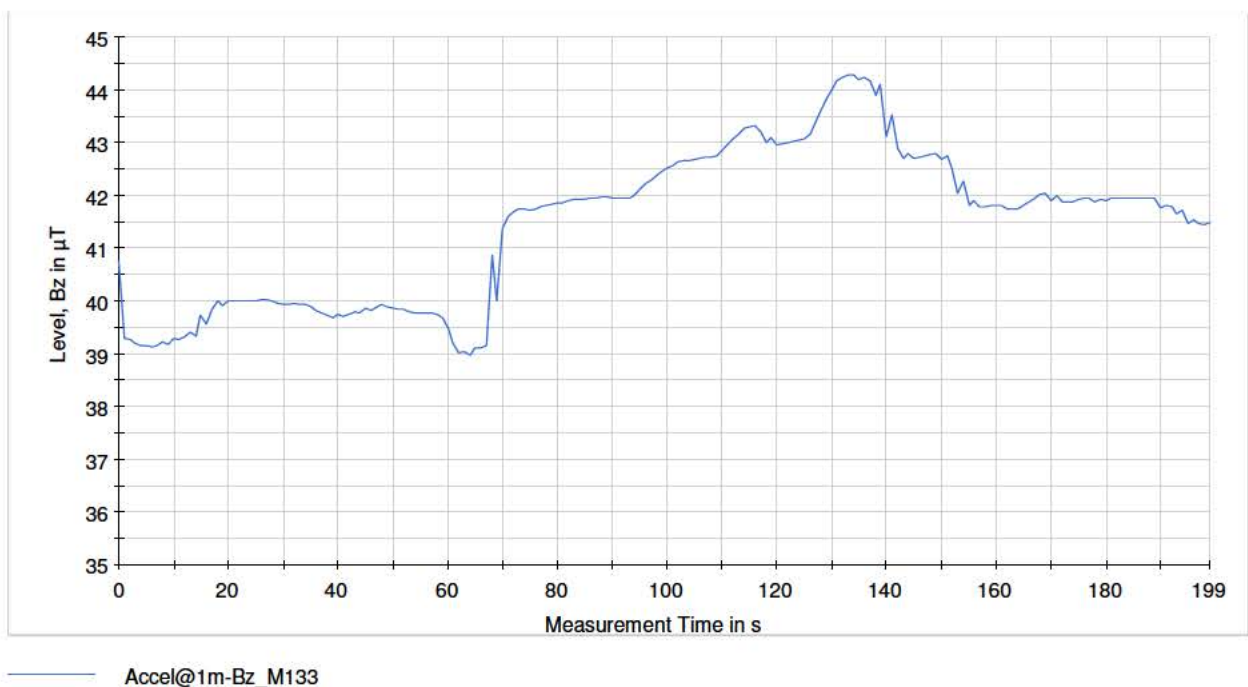

Date & Time	Direction	Operating condition / Train type	Train serial #		Estimated current during test [A]		Distance to track [m]	Height - sensor [m]	Remark
			1	2	Min	Max			
2018/11/23 15:47	W => O	Stoptrein (accel) / Flirt	2508	2229	-1248	1048	10	1	P-5, Bx-axis

Current data:

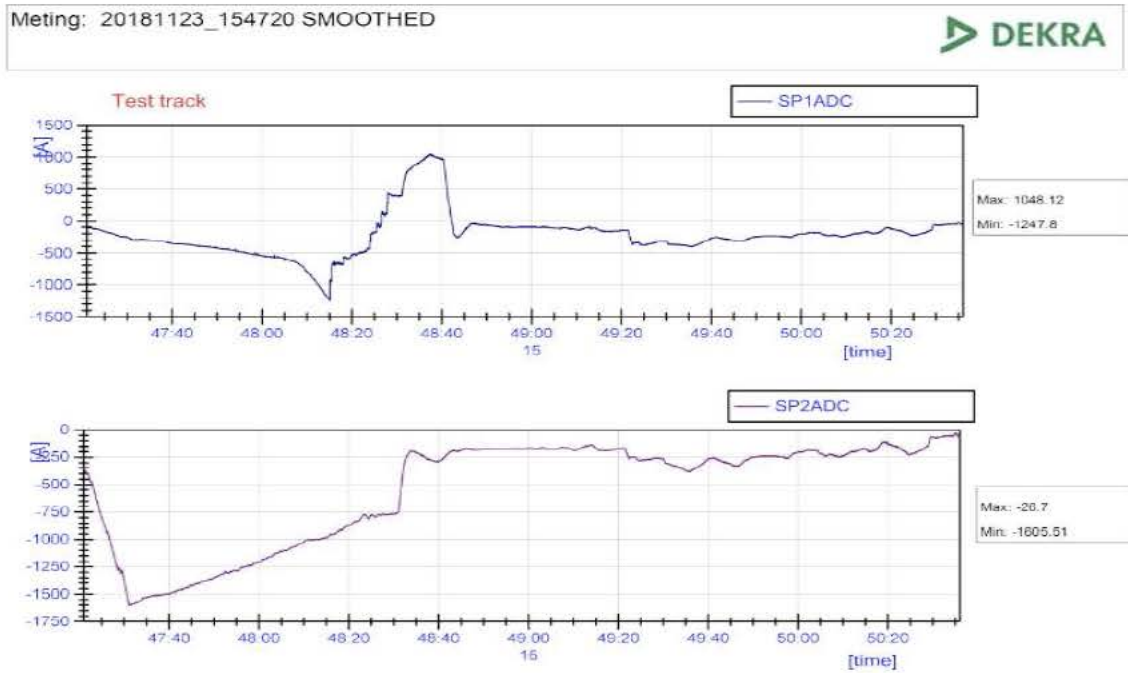

Measurement graphic:

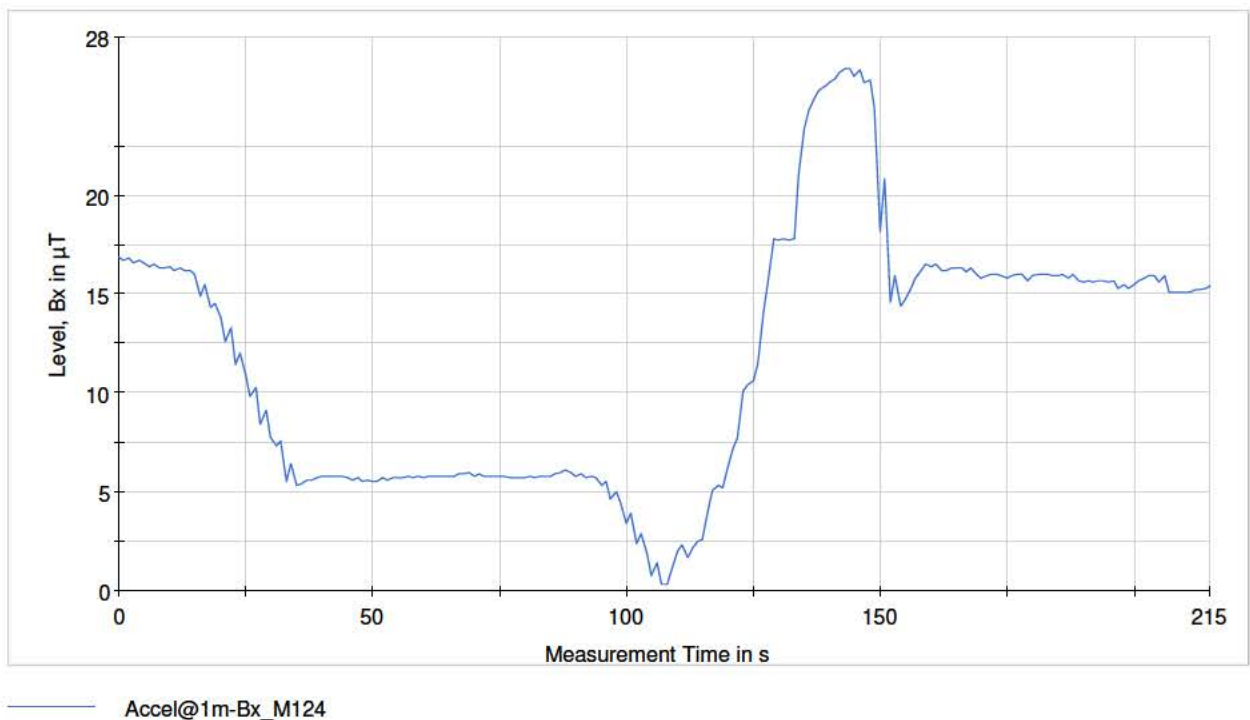

A1.25 Intercity-IC (transit), h=1 m., d=10 m.

Date & Time	Direction	Operating condition / Train type	Train serial #		Estimated current during test [A]		Distance to track [m]	Height - sensor [m]	Remark
			1	2	Min	Max			
2018/11/23 17:04	W => O	Intercity-IC (transit) / DDZ	7637	---	-385	182	10	1	P-5, Bz-axis

Current data:

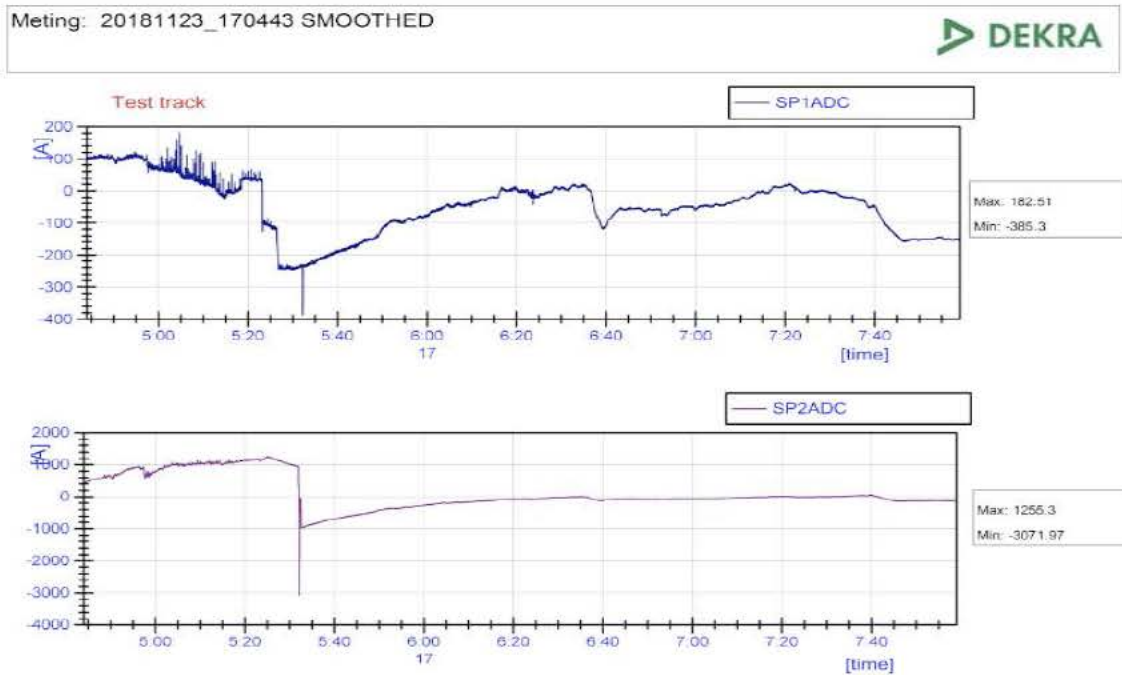

Measurement graphic:

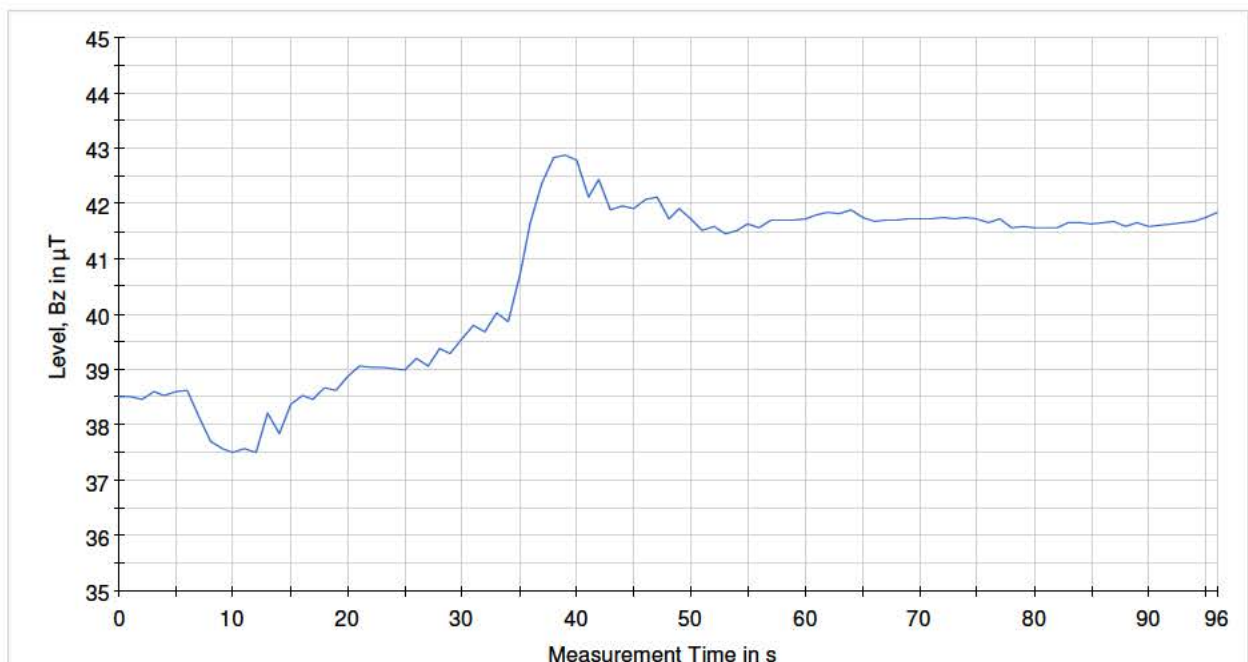

— Transit@1m-Bz_M130

Date & Time	Direction	Operating condition / Train type	Train serial #		Estimated current during test [A]		Distance to track [m]	Height - sensor [m]	Remark
			1	2	Min	Max			
2018/11/23 15:05	W => O	Intercity-IC (transit) / DDZ	7521	7646	-253	144	10	1	P-5, Bx-axis

Current data:

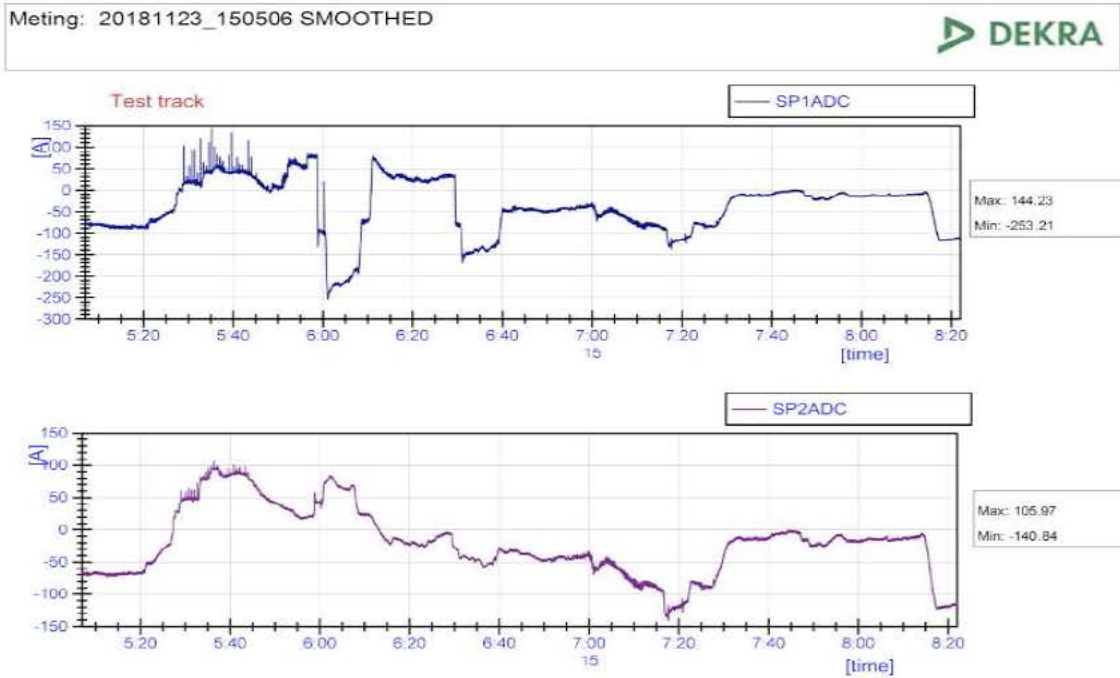

Measurement graphic:

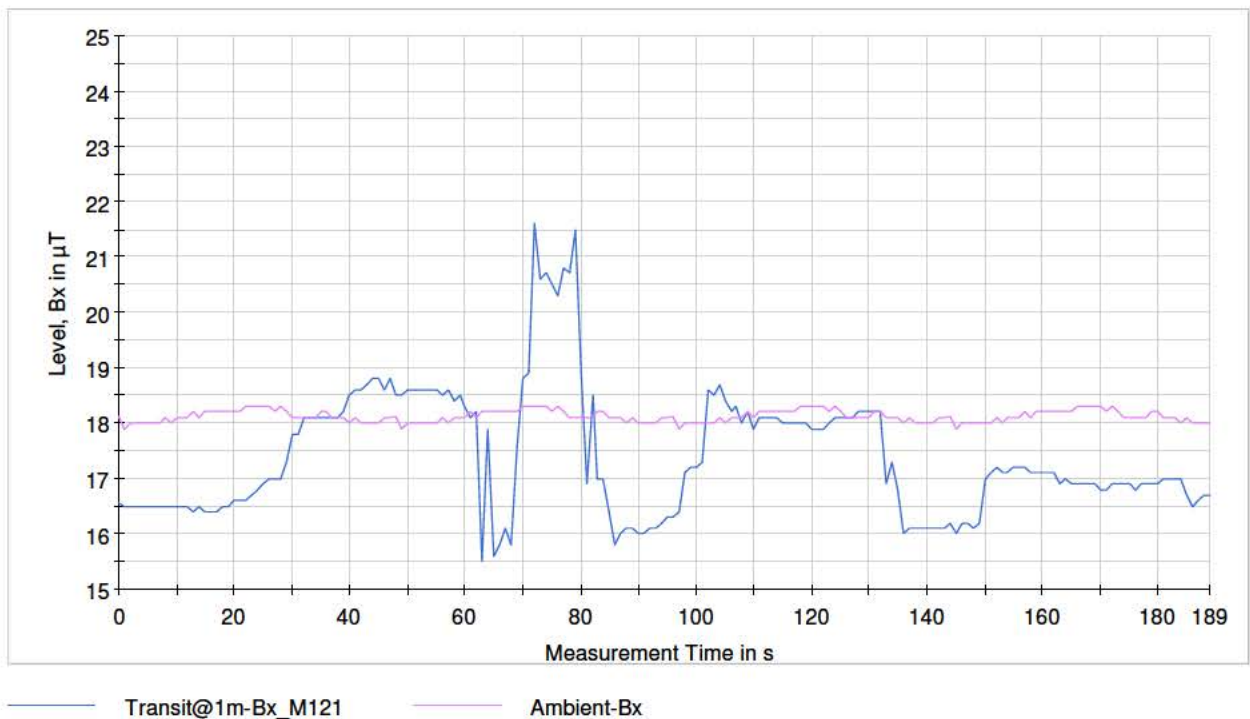

A1.26 Stoptrein (acceleration), h=1 m., d=30 m.

Date & Time	Direction	Operating condition / Train type	Train serial #		Estimated current during test [A]		Distance to track [m]	Height - sensor [m]	Remark
			1	2	Min	Max			
2018/11/26 15:17	W => O	Stoptrein (accel) / Flirt	2228	2507	-328	1328	30	1	P-6, Bz-axis

Current data:

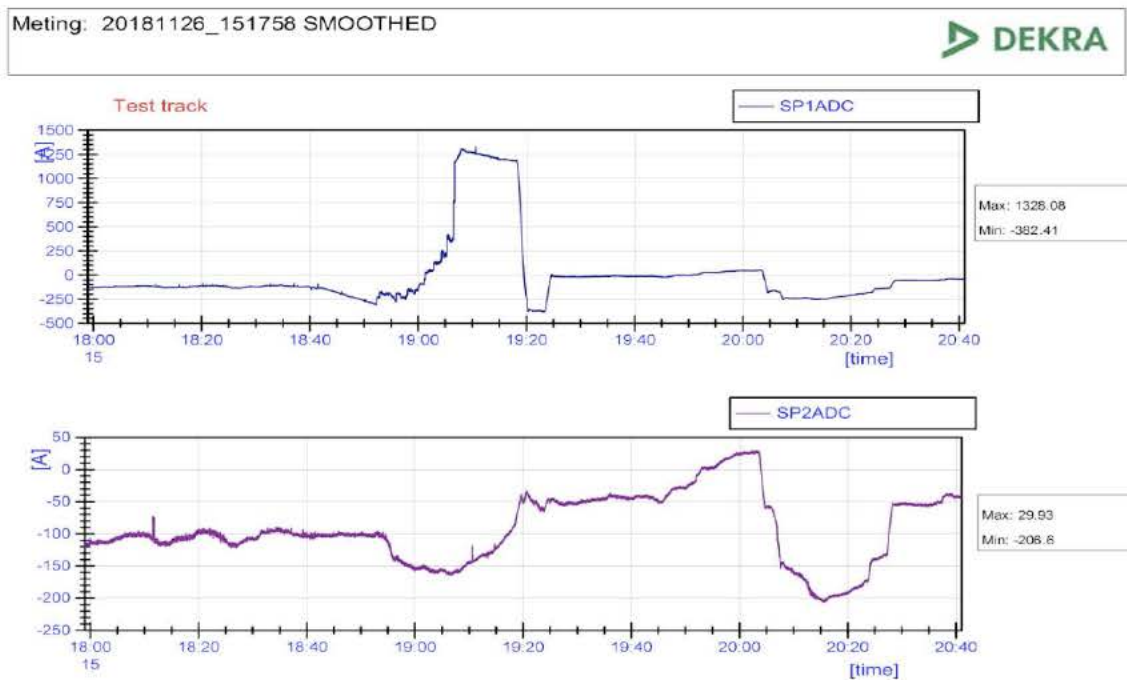

Measurement graphic:

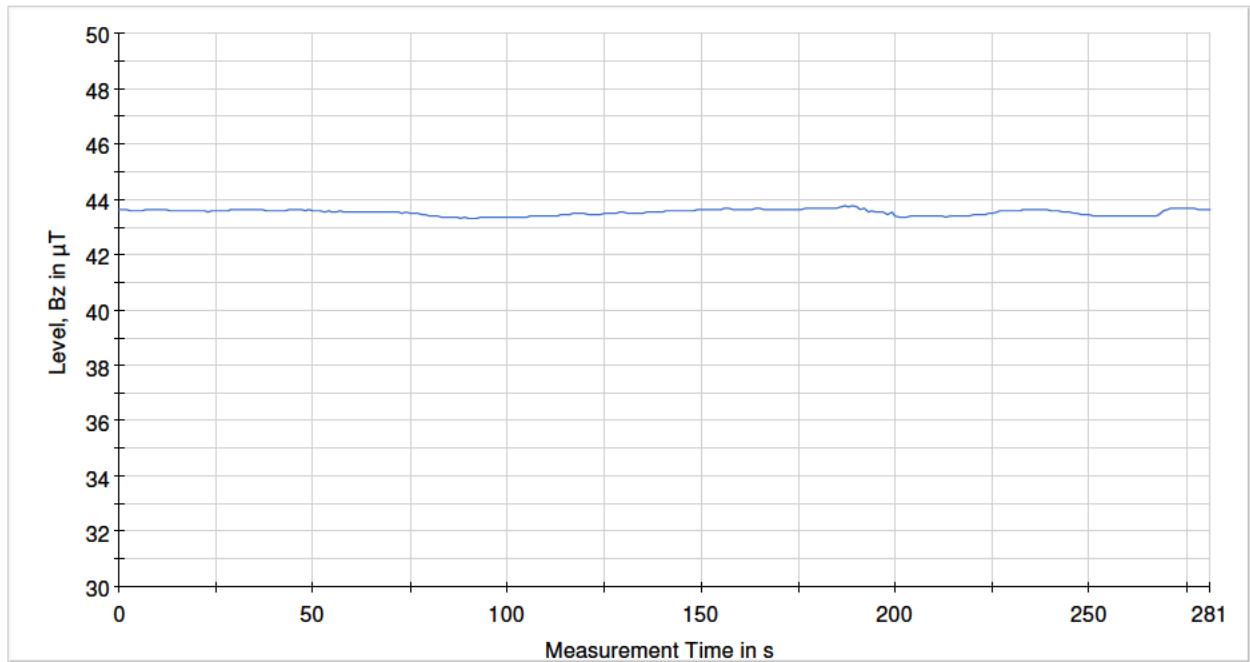

— Accel@1m-Bz_M143

Date & Time	Direction	Operating condition / Train type	Train serial #		Estimated current during test [A]		Distance to track [m]	Height - sensor [m]	Remark
			1	2	Min	Max			
2018/11/26 17:17	W => O	Stoptrein (accel) / Flirt	2505	2233	-946	640	30	1	P-6, Bx-axis

Current data:

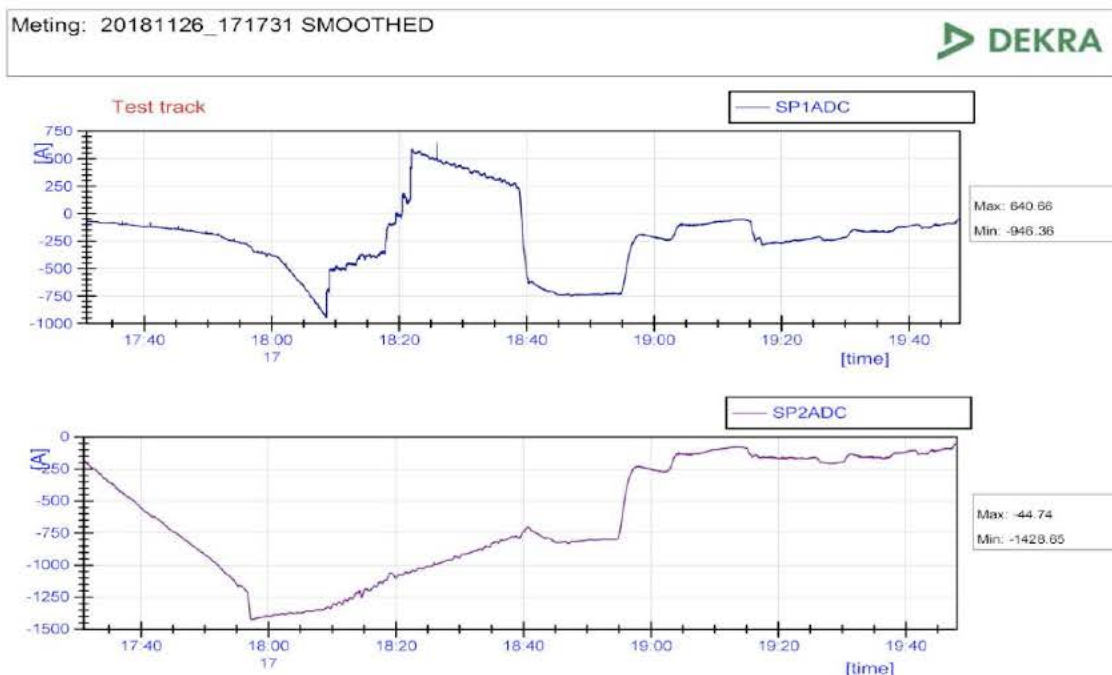

Measurement graphic:

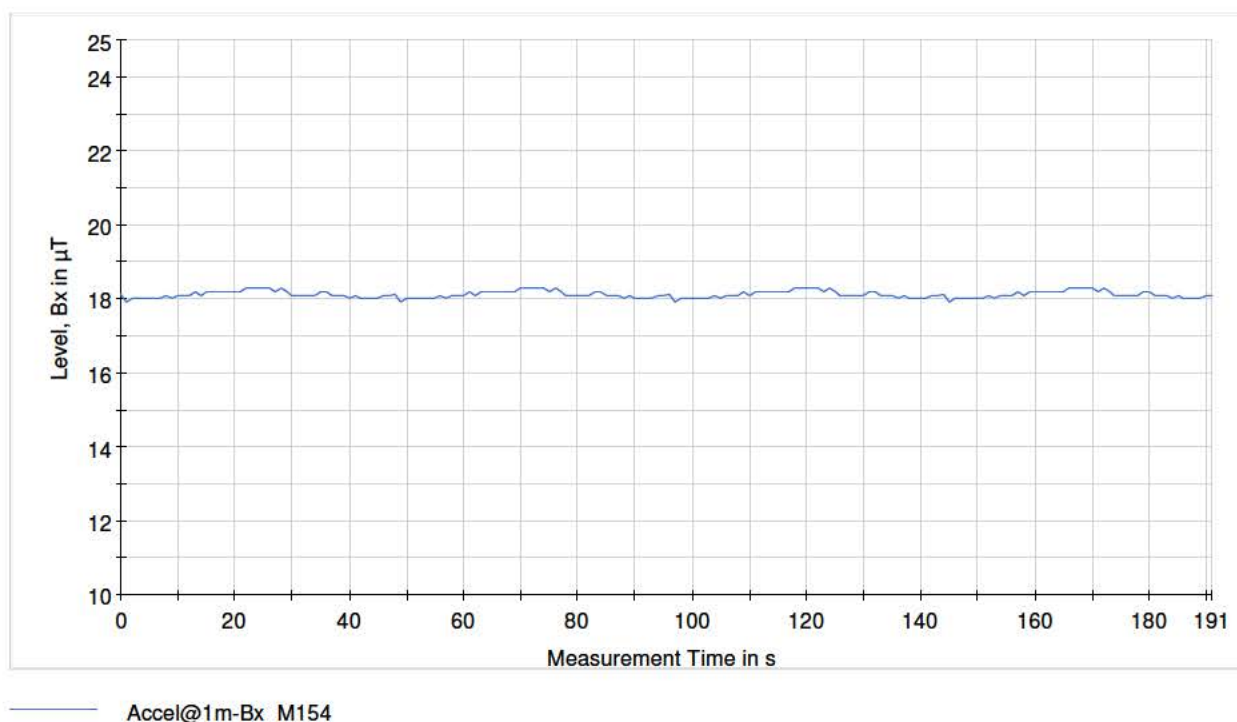

A1.27 Intercity-IC (transit), h=1 m., d=30 m.

Date & Time	Direction	Operating condition / Train type	Train serial #		Estimated current during test [A]		Distance to track [m]	Height - sensor [m]	Remark
			1	2	Min	Max			
2018/11/26 15:04	W => O	Intercity-IC (transit) / DDZ	7650	---	-250	54	30	1	P-6, Bz-axis

Current data:

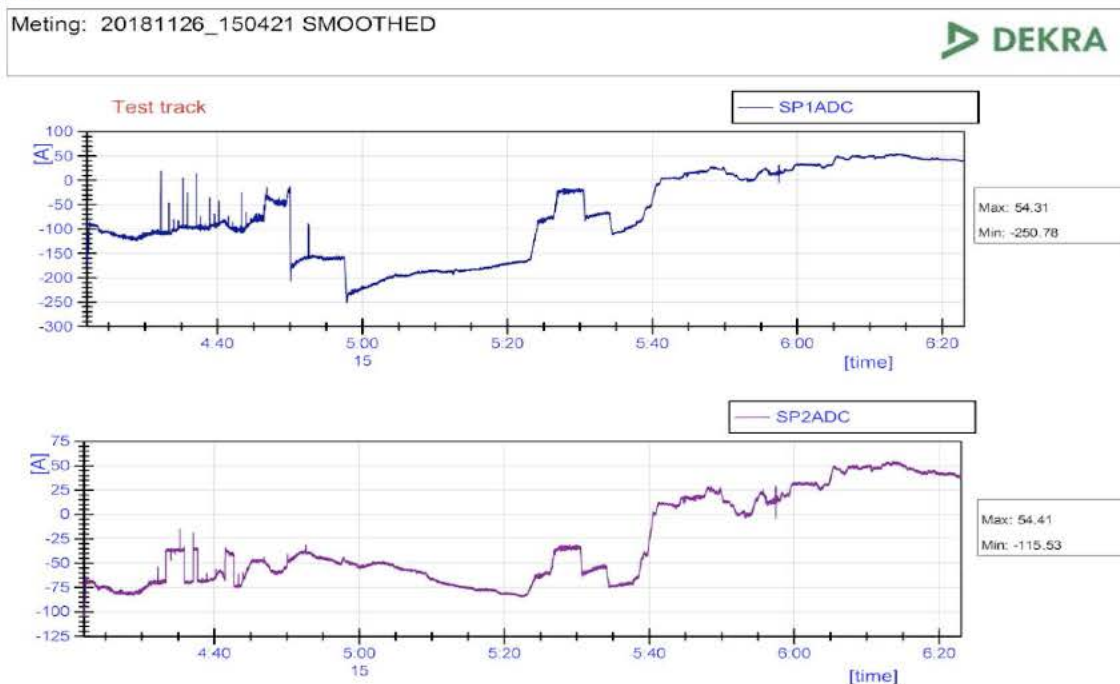

Measurement graphic:

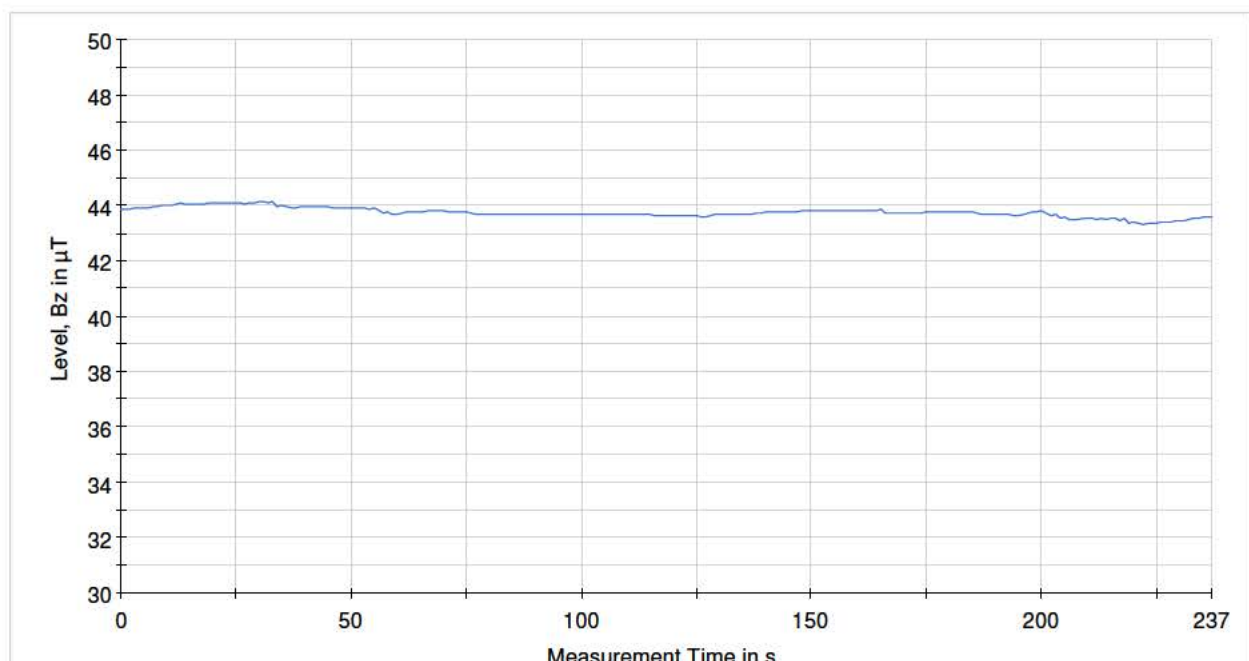

Transit@1m-Bz_M142

Date & Time	Direction	Operating condition / Train type	Train serial #		Estimated current during test [A]		Distance to track [m]	Height - sensor [m]	Remark
			1	2	Min	Max			
2018/11/26 17:34	W => O	Intercity-IC (transit) / DDZ	7612	---	-275	186	30	1	P-6, Bx-axis

Current data:

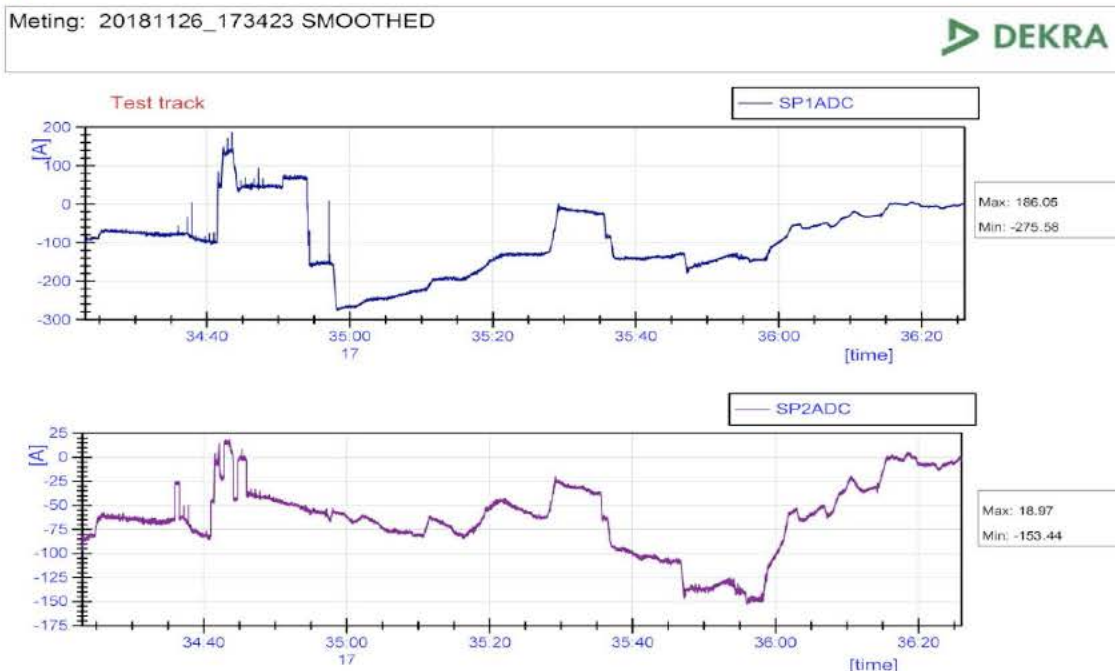

Measurement graphic:

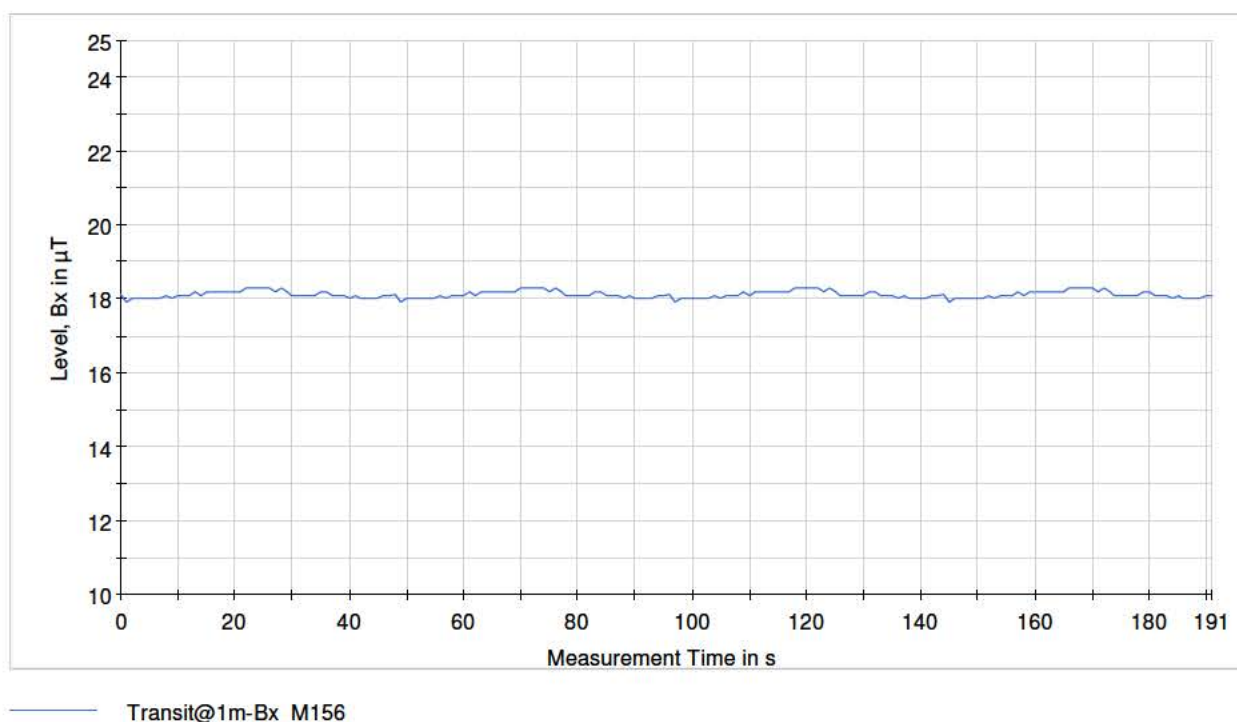

ANNEX 2: RADIATED EM FIELD EMISSION MEASUREMENT RESULTS (5 HZ – 30 MHZ)

A2.1 Stoptrain (acceleration)/ Transit / Braking, h=0 m., d=0 m.

The data given in this section has been obtained by doing long term (longer than 30 minutes) measurements when the sensor was located between the rails of the test track. The measurement data (EM field level) has been recorded continuously during stoptrains, transit trains and braking trains on track SP2ADC. The current data given below is the highest current measured during this period.

Date & Time	Direction	Operating condition / Train type	Train serial #		Estimated current during test [A]		Distance to track [m]	Height - sensor [m]	Remark
			1	2	Min	Max			
2018/11/23 11:48	W => O ¹⁾	Stoptrain / Flirt	2204	2219	-871	1237	0	0	P-1

¹⁾ Oss-West => Oss

Current data:

Meting: 20181123_114812 SMOOTHED

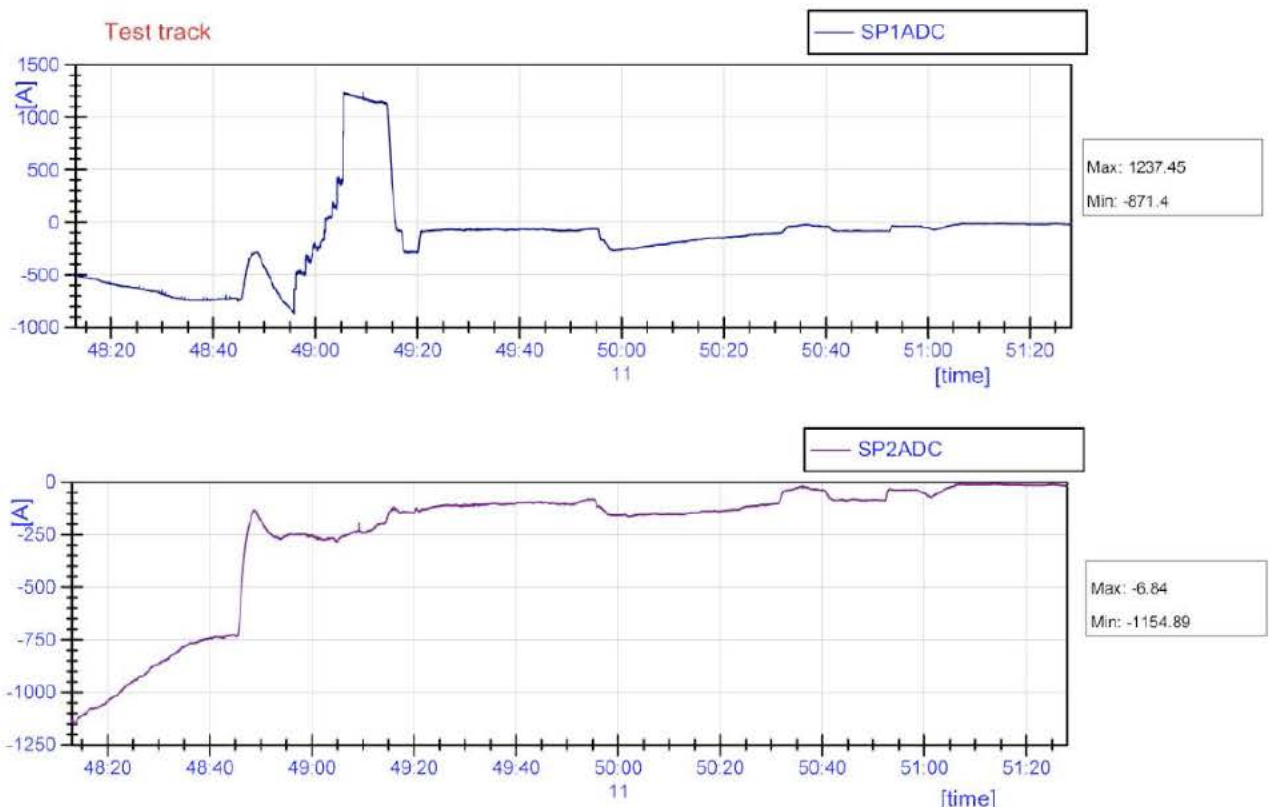

Measurement graphic:

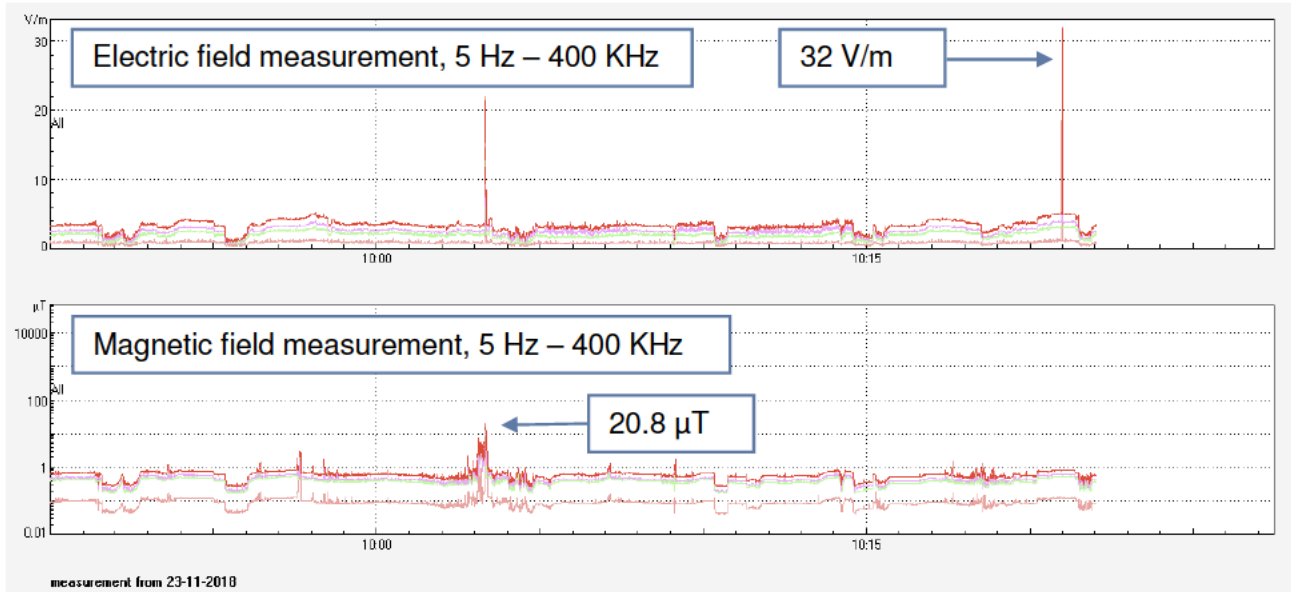

These lines show the position where the measurements have been paused.

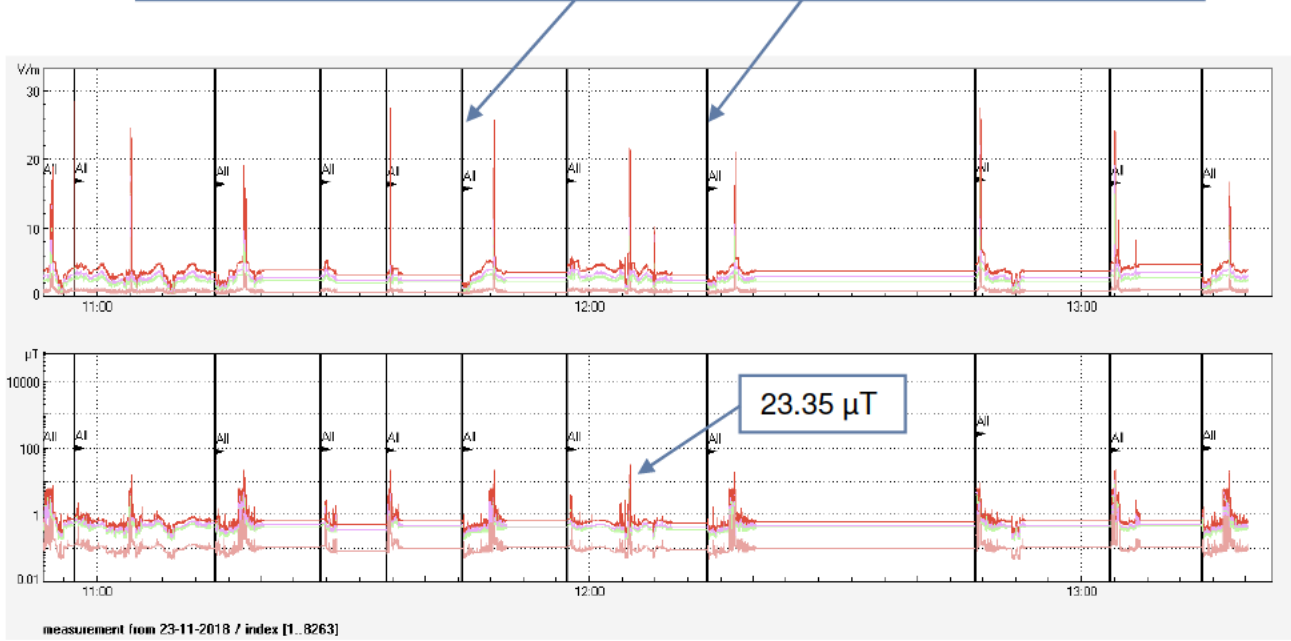

The data given below has been obtained by using magnetic loop antenna) which was located between the rails of the test track. The purpose of the measurements were only to identify the frequencies which are present in the railway environment at frequency range 20 Hz – 500 KHz. The measurement data has been recorded using peak detector and “max-hold” function of the spectrum analyzer. The measurements have been performed at the operating conditions acceleration, transit and braking of the train.

Date & Time	Direction	Operating condition / Train type	Train serial #		Estimated current during test [A]		Distance to track [m]	Height - antenna [m]	Remark
			1	2	Min	Max			
2018/11/23 12:47	W => O ¹⁾	Stoptrein / Flirt	2525	2227	-692	360	0	0	P-1, Z-axis

¹⁾ Oss-West => Oss

Current data:

Meting: 20181123_124723 SMOOTHED

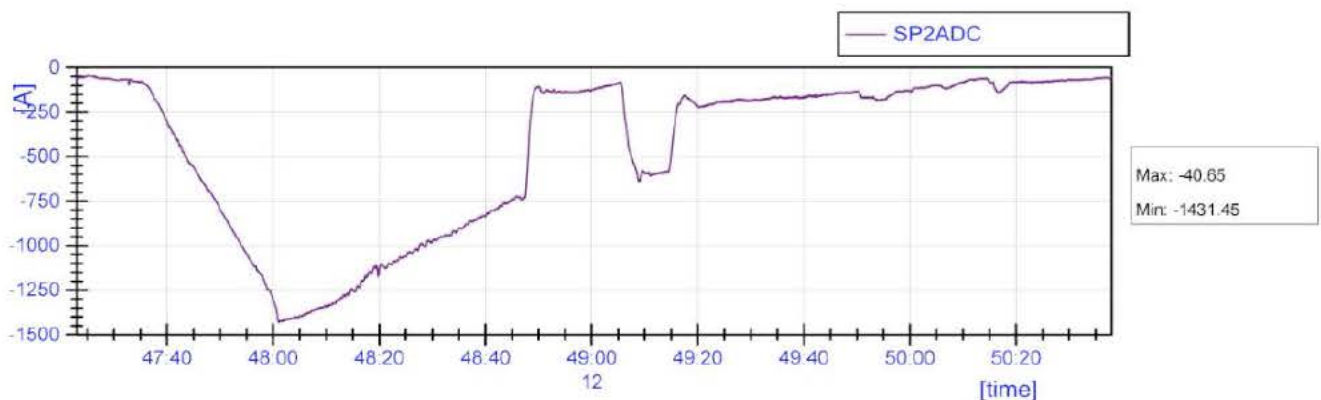
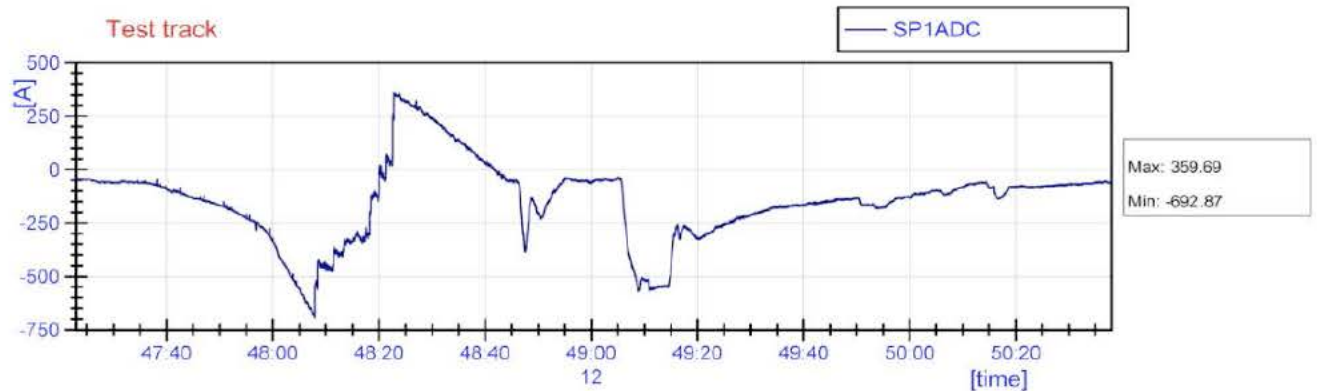

Measurement graphic:

Subrange	Step Size	Detectors	Bandwidth	Sweep Time	Preamp
20 Hz - 1 kHz	2.45 Hz	PK+	10 Hz	Coupled	0 dB

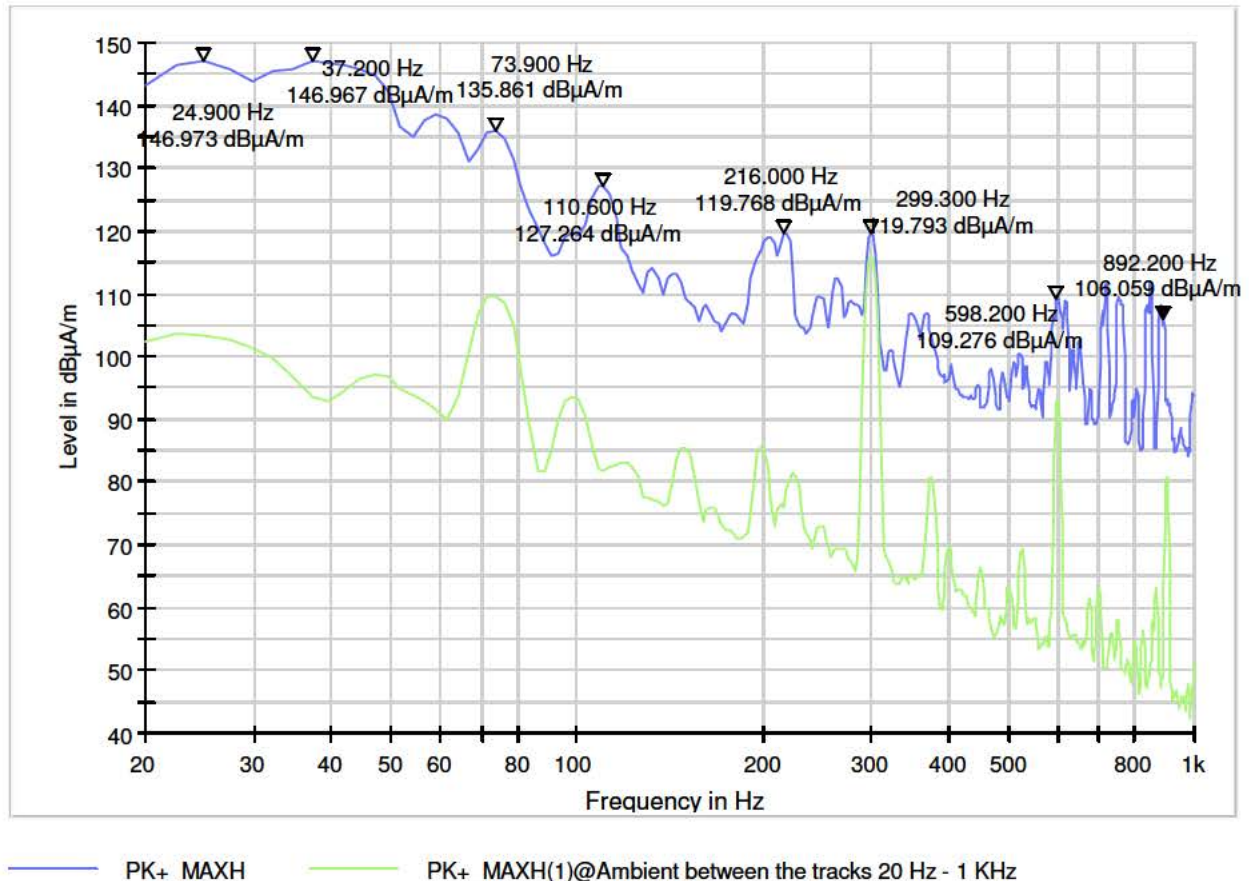

The green graphic line belongs to the ambient measurement when there is no train on the track. The blue one has been recorded when the train was on the track. The difference between the green and blue graphic lines show the increase of the EM field strenght due to the train.

The same comment is also valid for the other graphics given below.

Date & Time	Direction	Operating condition / Train type	Train serial #		Estimated current during test [A]		Distance to track [m]	Height - antenna [m]	Remark
			1	2	Min	Max			
2018/11/23 12:35	W => O	Transit / DDZ	7616	---	-163	128	0	0	P-1, Z-axis

Current data:

Meting: 20181123_123540 SMOOTHED

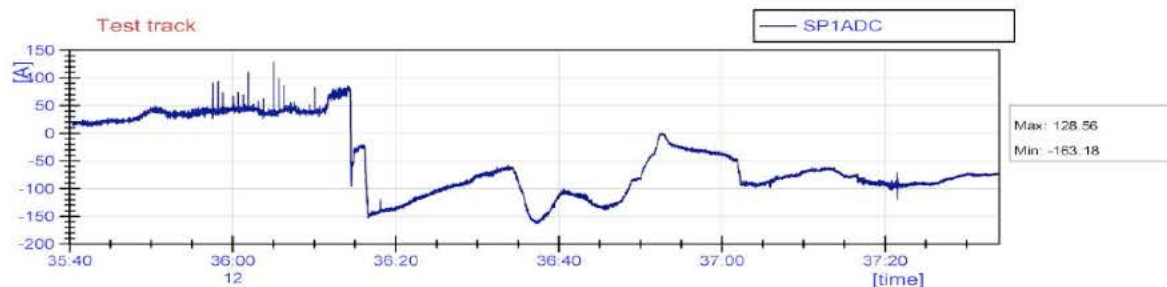

Measurement graphic:

Subrange 20 Hz - 1 kHz Step Size 2.45 Hz Detectors PK+ Bandwidth 10 Hz Sweep Time Coupled Preamp 0 dB

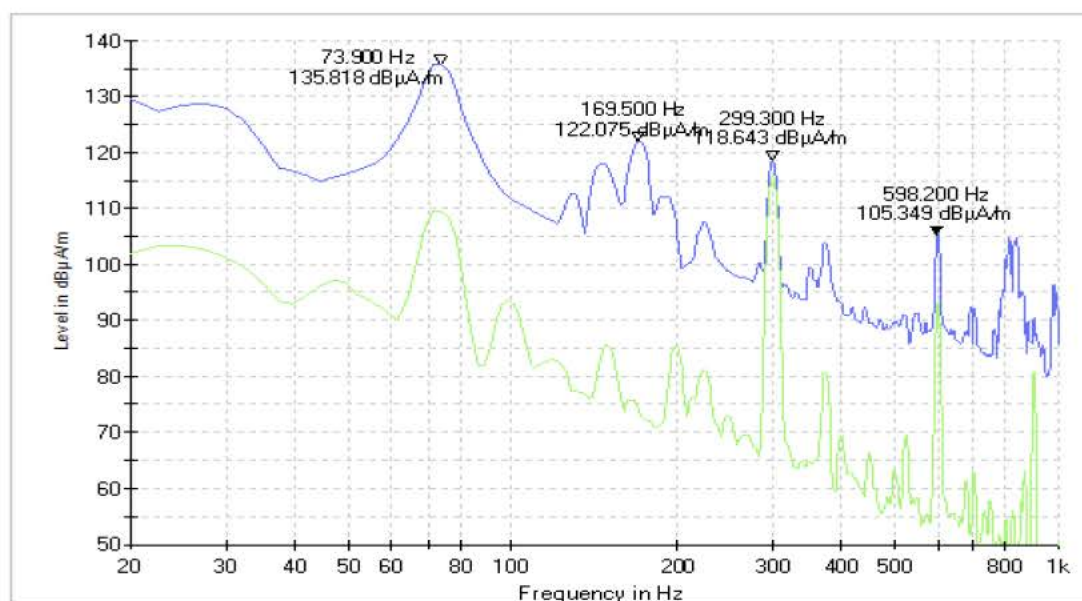

— PK+_MAXH — PK+_MAXH(1)@M1 a 20Hz-1K ambient between the tracks 12-44

Date & Time	Direction	Operating condition / Train type	Train serial #		Estimated current during test [A]		Distance to track [m]	Height - antenna [m]	Remark
			1	2	Min	Max			
2018/11/23 12:47	O => W ¹⁾	Braking on SP2ADC / Flirt	---	---	-1431	-40	0	0	P-1, Z-axis

¹⁾ Oss => Oss-West

Current data:

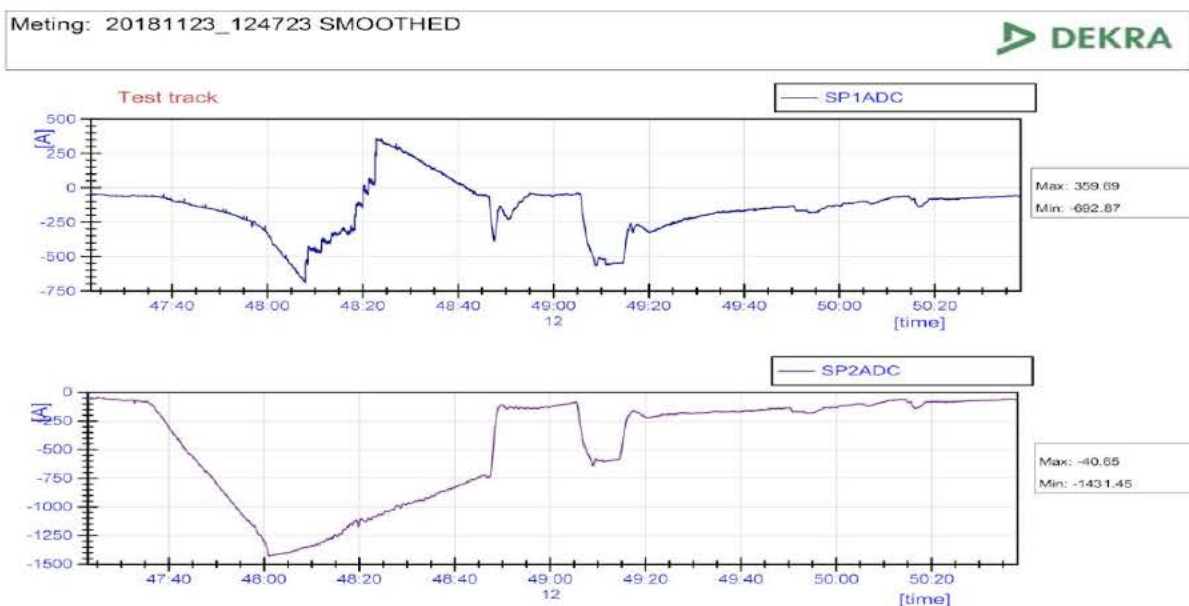

Measurement graphic:

Subrange 20 Hz - 1 kHz Step Size 2.45 Hz Detectors PK+ Bandwidth 10 Hz Sweep Time Coupled Preamp 0 dB

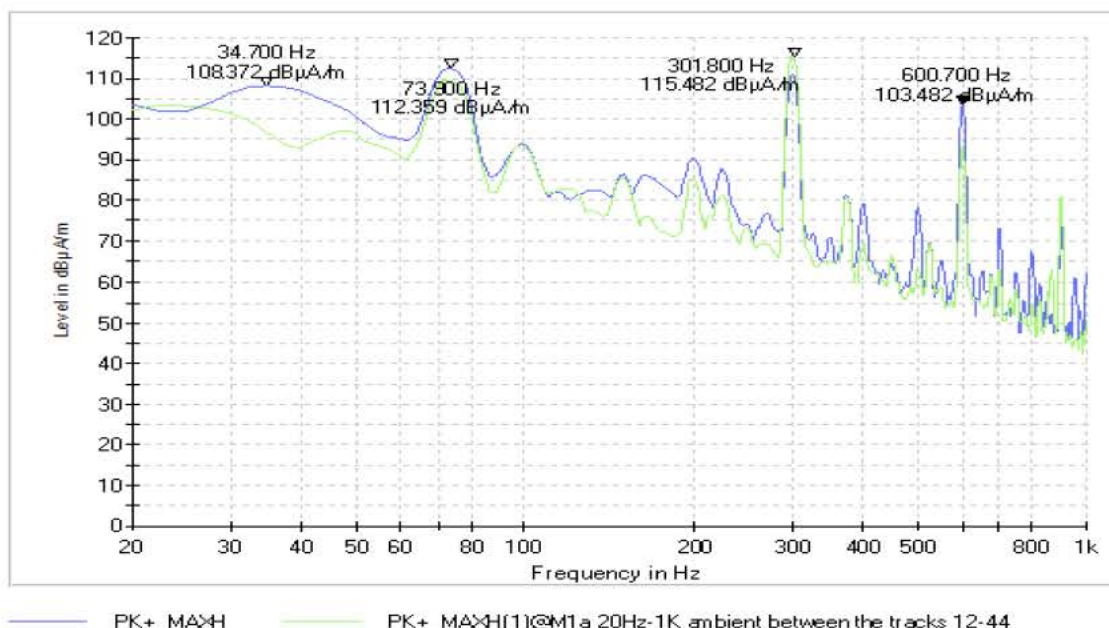

Date & Time	Direction	Operating condition / Train type	Train serial #		Estimated current during test [A]		Distance to track [m]	Height - antenna [m]	Remark
			1	2	Min	Max			
2018/11/23 13:17	W => O	Stoptrein / Flirt	2522	---	-640	331	0	0	P-1, Z-axis

Current data:



Measurement graphic:

Subrange 1 kHz - 10 kHz Step Size 22.5 Hz Detectors PK+ Bandwidth 100 Hz Sweep Time Coupled Preamp 20 dB

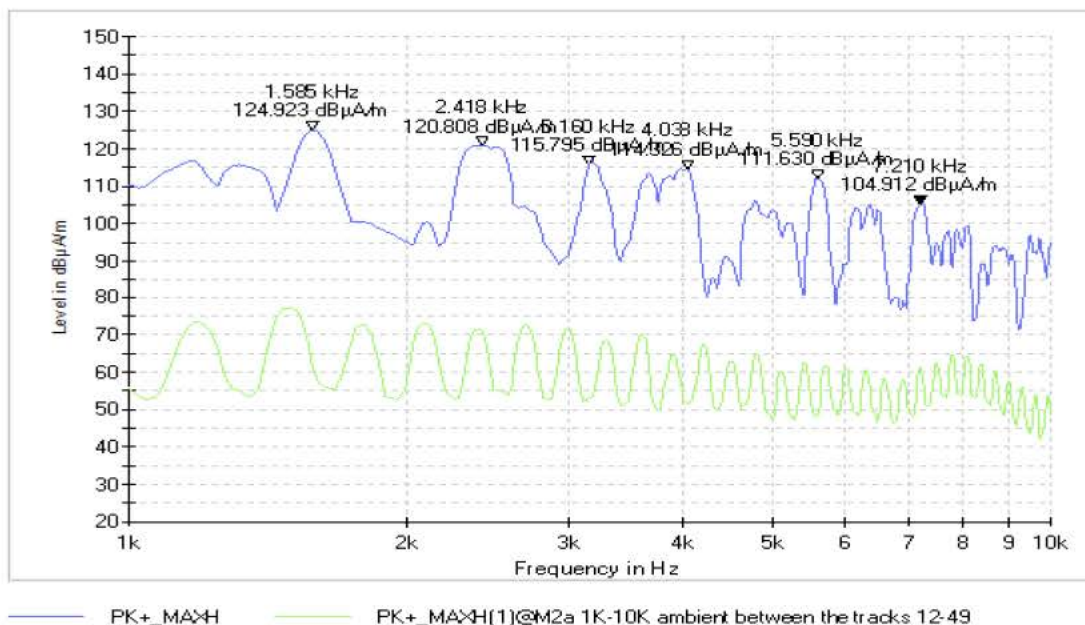

Date & Time	Direction	Operating condition / Train type	Train serial #		Estimated current during test [A]		Distance to track [m]	Height - antenna [m]	Remark
			1	2	Min	Max			
2018/11/23 13:04	W => O	Transit-IC / ICM	4247	4024	-159	232	0	0	P-1, Z-axis

Current data:

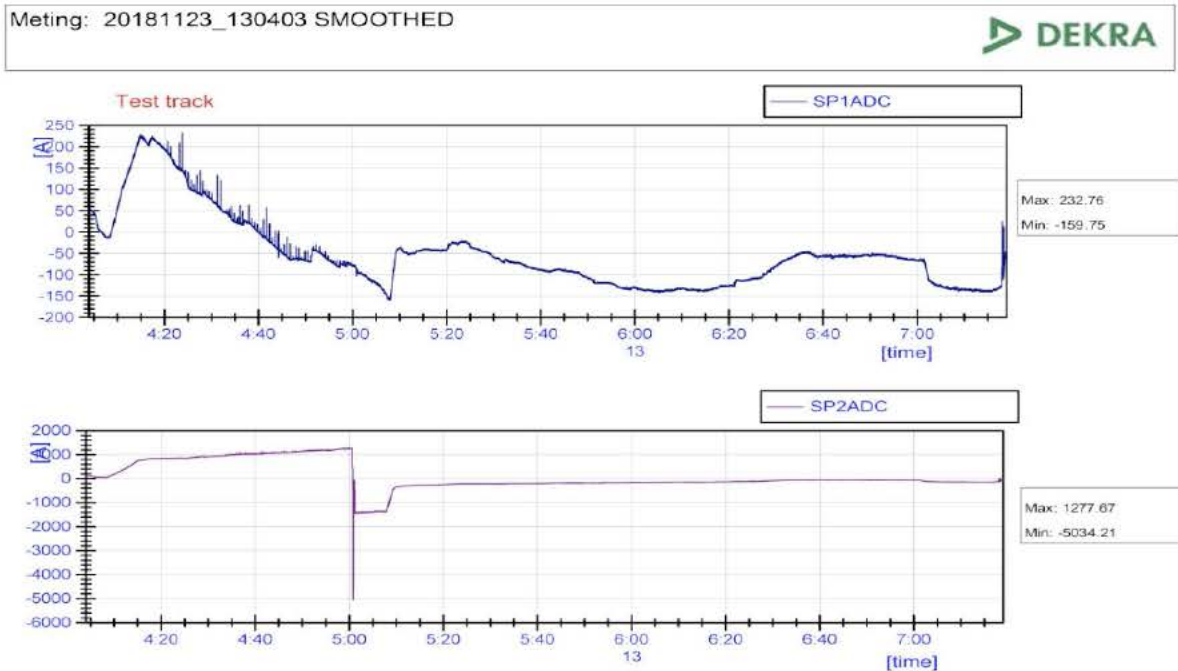

Measurement graphic:

Subrange 1 kHz - 10 kHz Step Size 22.5 Hz Detectors PK+ Bandwidth 100 Hz Sweep Time Coupled Preamp 20 dB

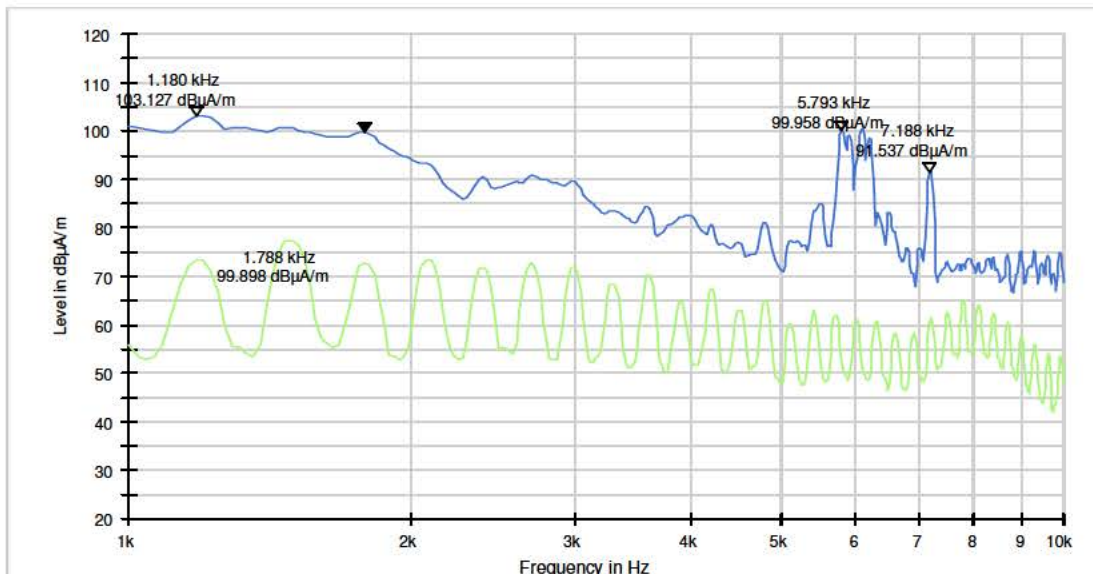

— PK+_MAXH@M4 1K-10K transit@track1 and 2 (freight train) antenna btw the tracks
 — PK+_MAXH@M2a 1K-10K ambient

Date & Time	Direction	Operating condition / Train type	Train serial #		Estimated current during test [A]		Distance to track [m]	Height - antenna [m]	Remark
			1	2	Min	Max			
2018/11/23 13:47	W => O	Stoptrein / Flirt	2209	2518	-385	777	0	0	P-1, Z-axis

Current data:

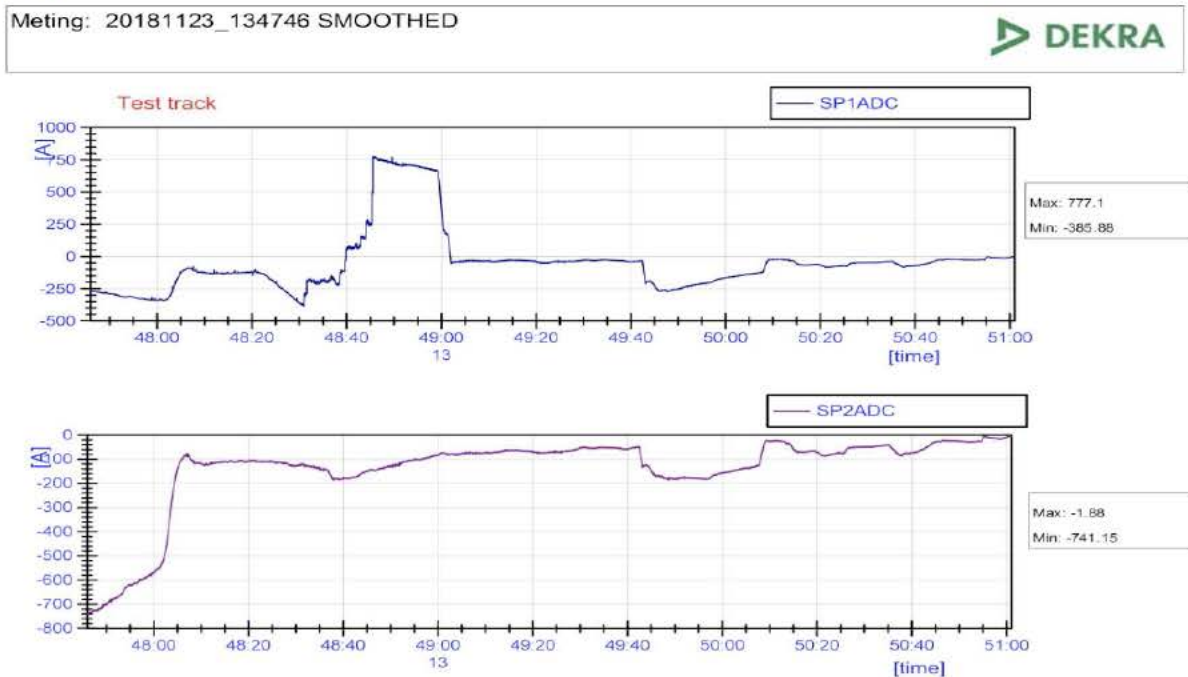

Measurement graphic:

Subrange 10 kHz - 500 kHz Step Size 245 Hz Detectors PK+ Bandwidth 1 kHz Sweep Time Coupled Preamp 20 dB

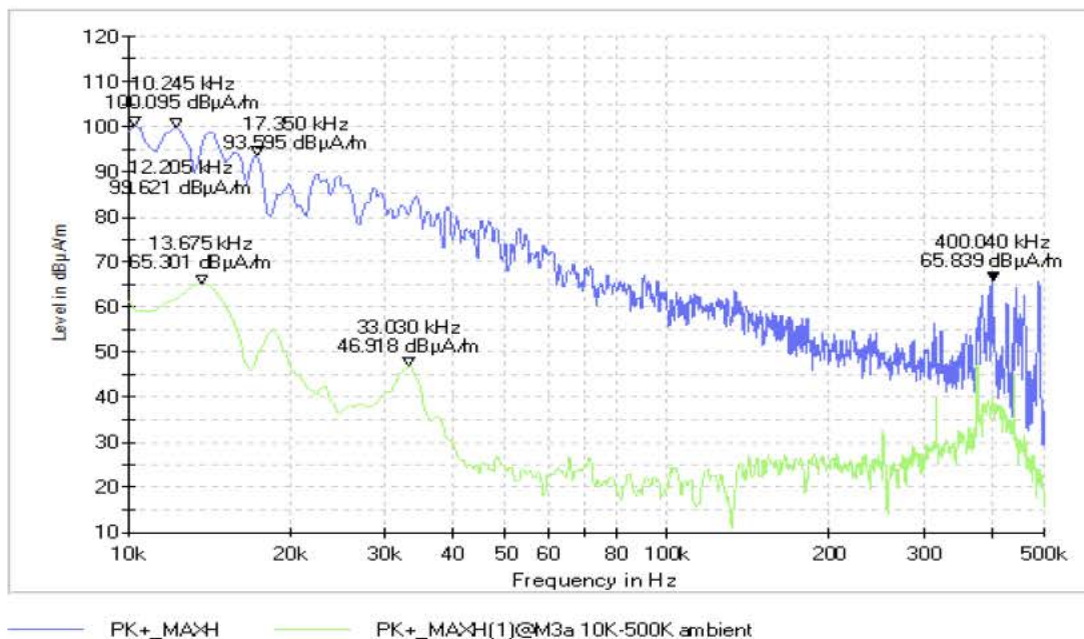

Date & Time	Direction	Operating condition / Train type	Train serial #		Estimated current during test [A]		Distance to track [m]	Height - antenna [m]	Remark
			1	2	Min	Max			
2018/11/23 13:34	W => O	Transit-IC / DDZ	7637	---	-200	71	0	0	P-1, Z-axis

Current data:

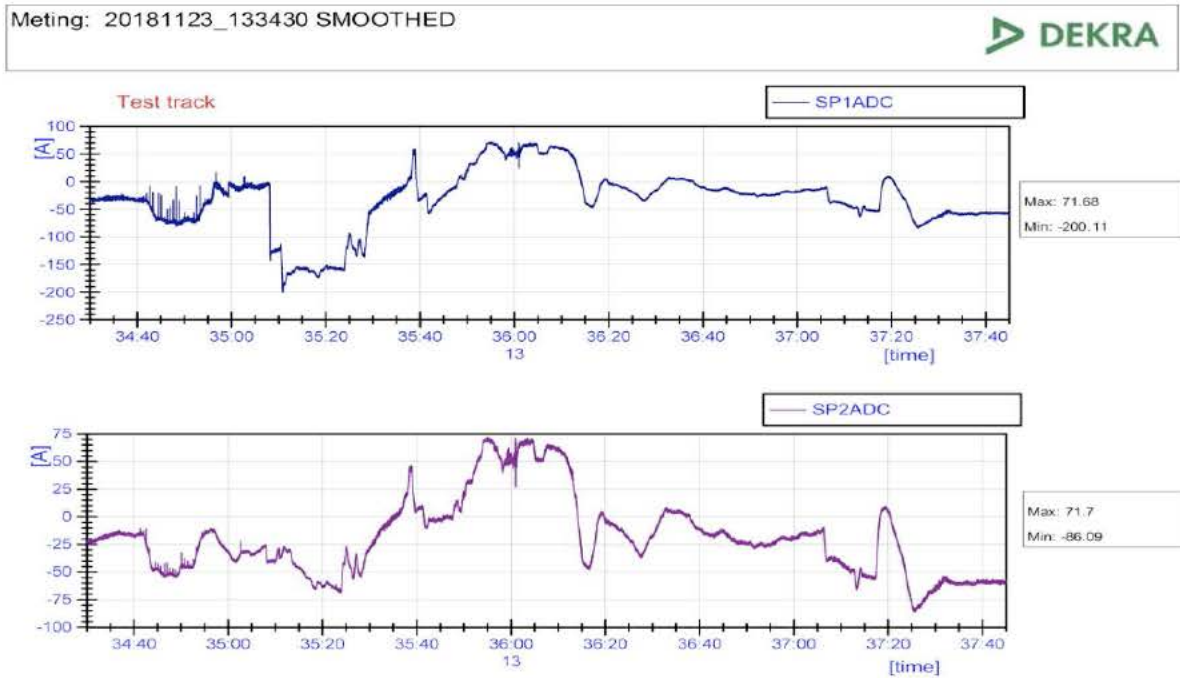

Measurement graphic:

Subrange 10 kHz - 500 kHz **Step Size** 245 Hz **Detectors** PK+ **Bandwidth** 1 kHz **Sweep Time** Coupled **Preamp** 20 dB

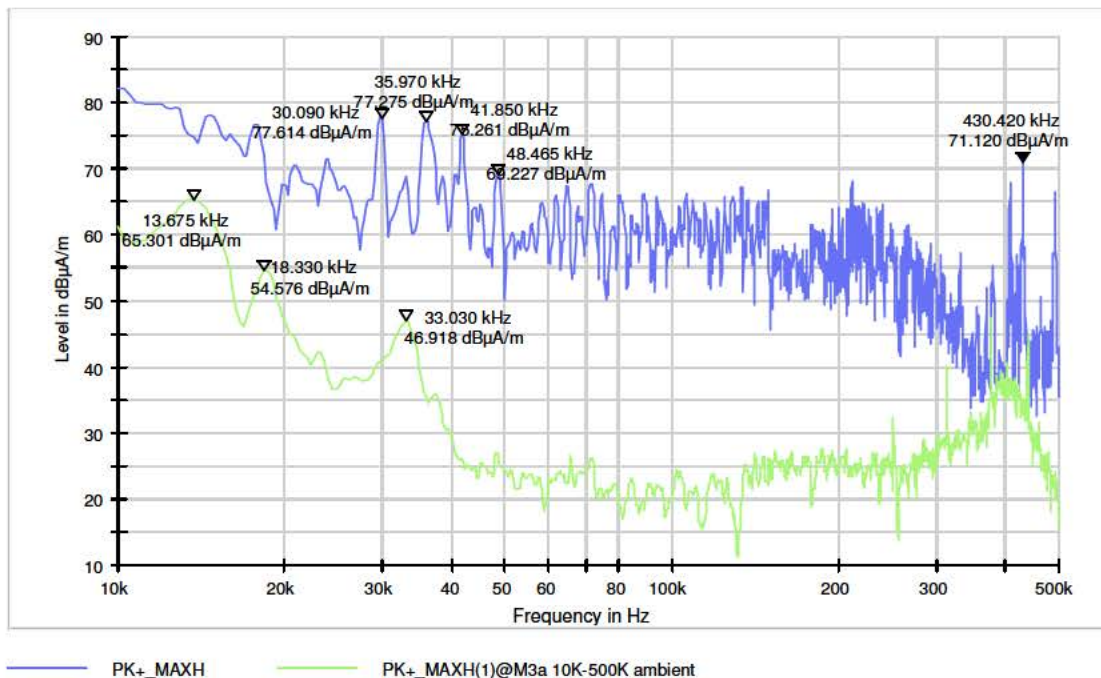

Date & Time	Direction	Operating condition / Train type	Train serial #		Estimated current during test [A]		Distance to track [m]	Height - antenna [m]	Remark
			1	2	Min	Max			
2018/11/23 13:45	O => W	Braking on SP2ADC / Flirt	2xxx	2xxx	-286	167	0	0	P-1, Z-axis

Current data:

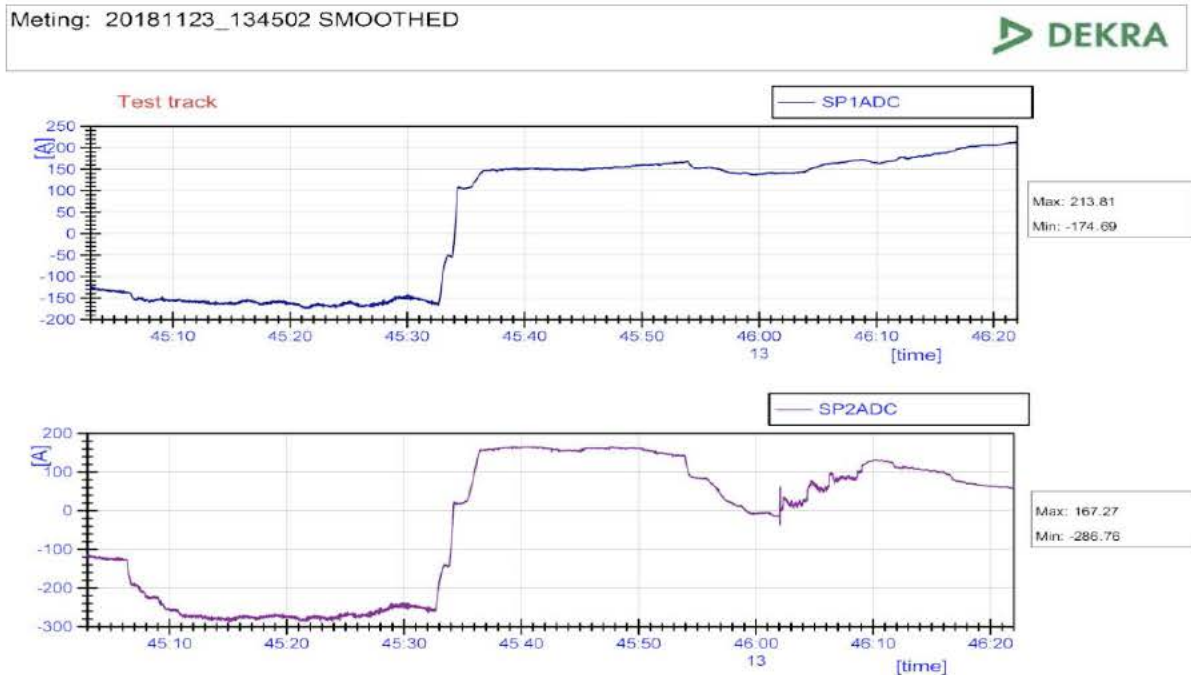

Measurement graphic:

Subrange: 10 kHz - 500 kHz Step Size: 245 Hz Detectors: PK+ Bandwidth: 1 kHz Sweep Time: Coupled Preamp: 20 dB

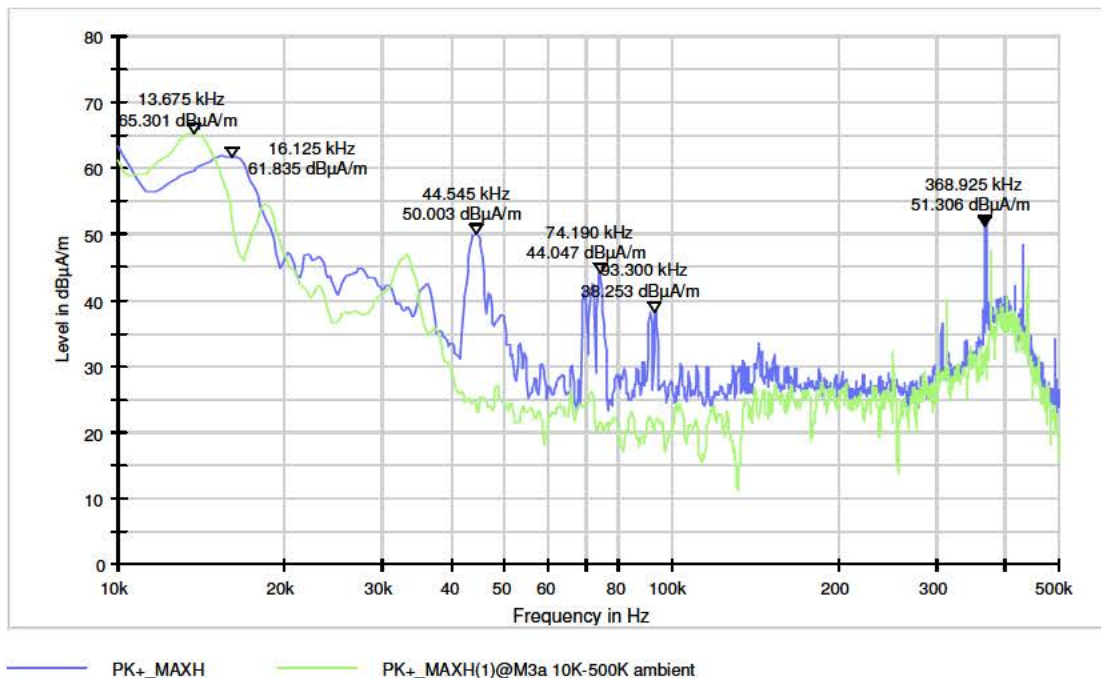

A2.2 Stoptrain (acceleration)/ Transit / Braking, h=0.3 m., d=1.25 m. (5 Hz – 400 KHz)

Date & Time	Direction	Operating condition / Train type	Train serial #		Estimated current during test [A]		Distance to track [m]	Height - sensor [m]	Remark
			1	2	Min	Max			
2018/11/20 14:18	W => O	Stoptrain / Flirt	2232	2512	-439	856	1.25	0.3	P-2

Current data:

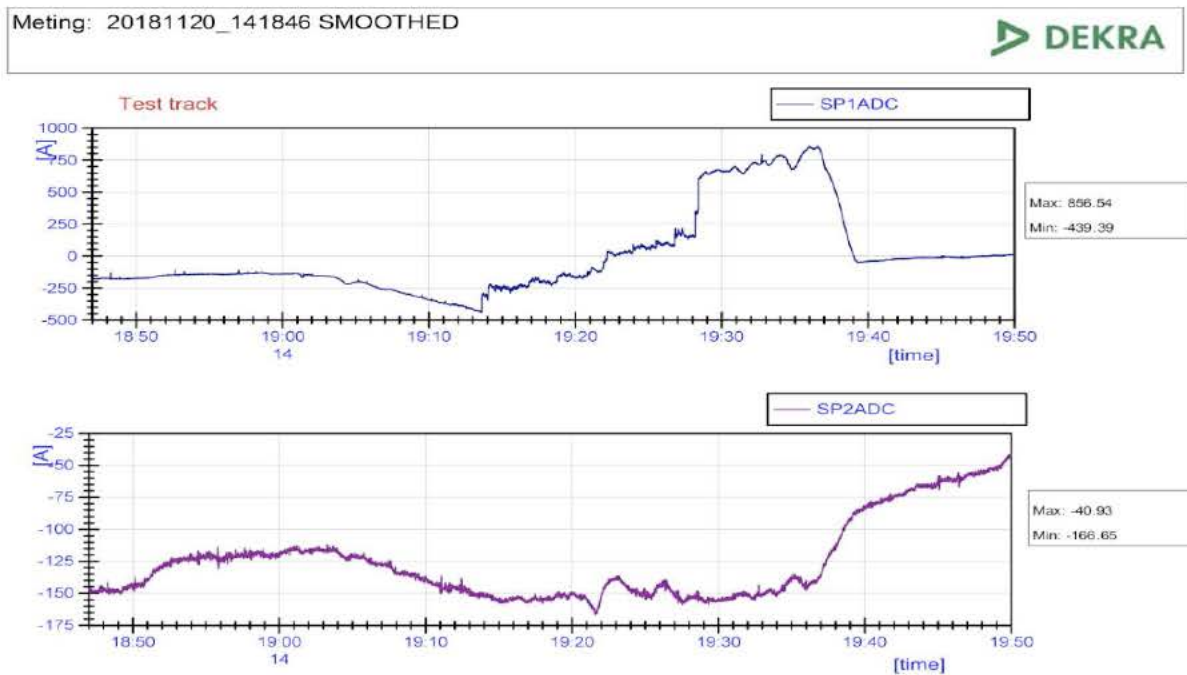

Measurement graphic:

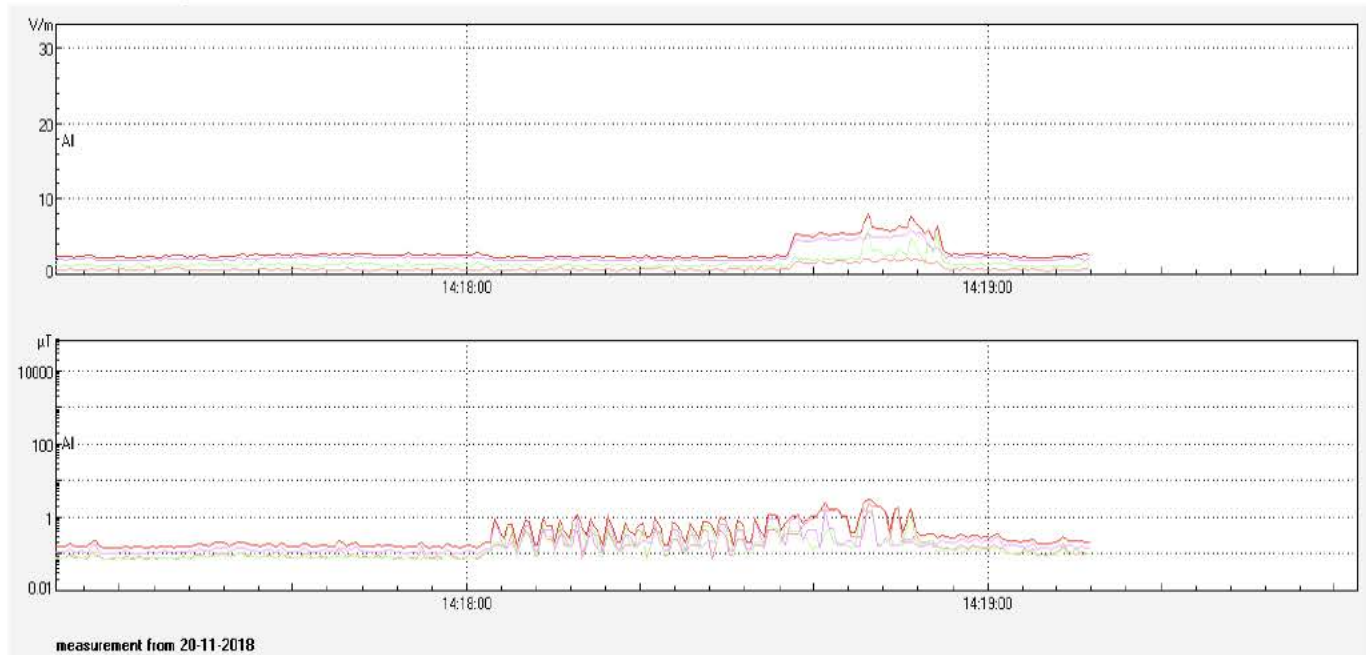

Date & Time	Direction	Operating condition / Train type	Train serial #		Estimated current during test [A]		Distance to track [m]	Height - sensor [m]	Remark
			1	2	Min	Max			
2018/11/20 13:04	W => O	Transit-IC / DDZ	7650	---	-235	80	1.25	0.3	P-2

Current data:

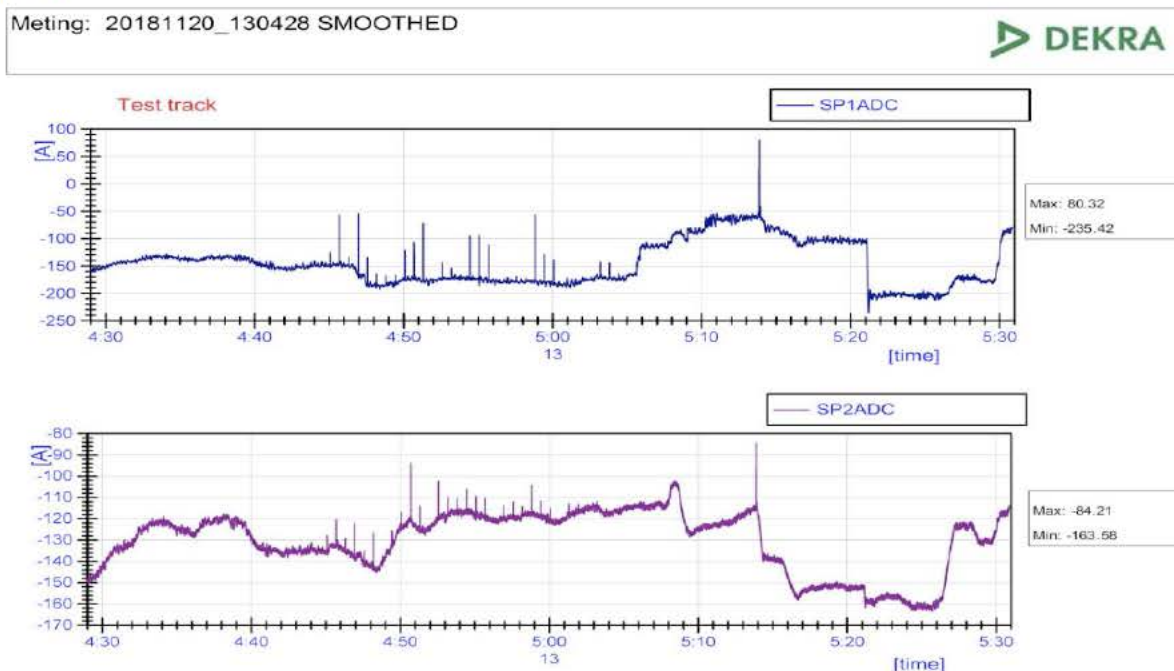

Measurement graphic:

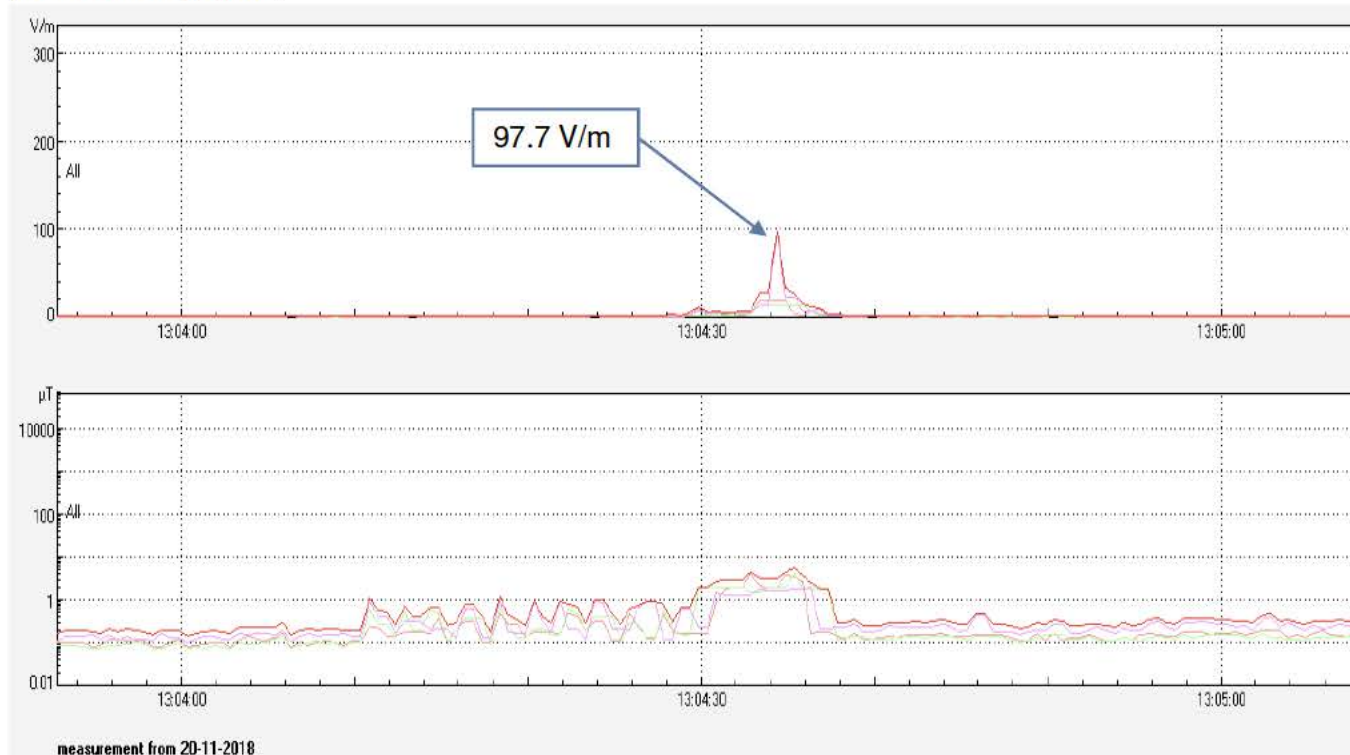

A2.3 Stoptrain (acceleration)/ Transit / Braking, h=1 m., d=1.25 m. (5 Hz – 400 KHz)

Date & Time	Direction	Operating condition / Train type	Train serial #		Estimated current during test [A]		Distance to track [m]	Height - sensor [m]	Remark
			1	2	Min	Max			
2018/11/19 10:48	W => O	Stoptrain / Flirt	2224	---	-710	591	1.25	1	P-2

Current data:

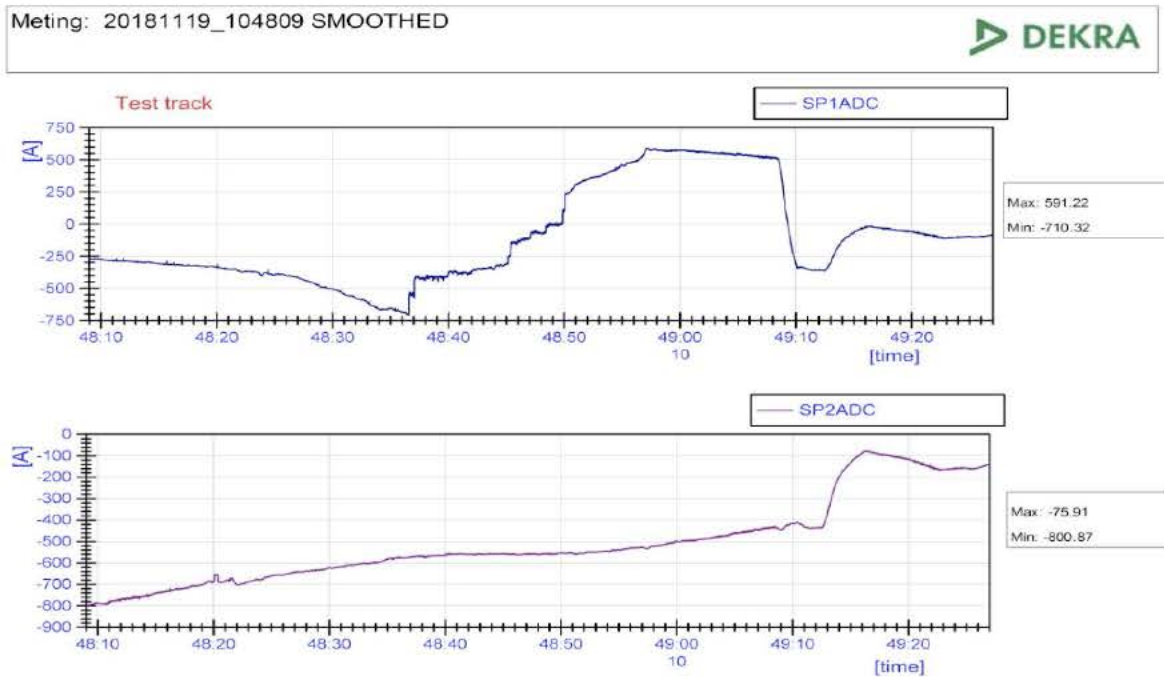

Measurement graphic:

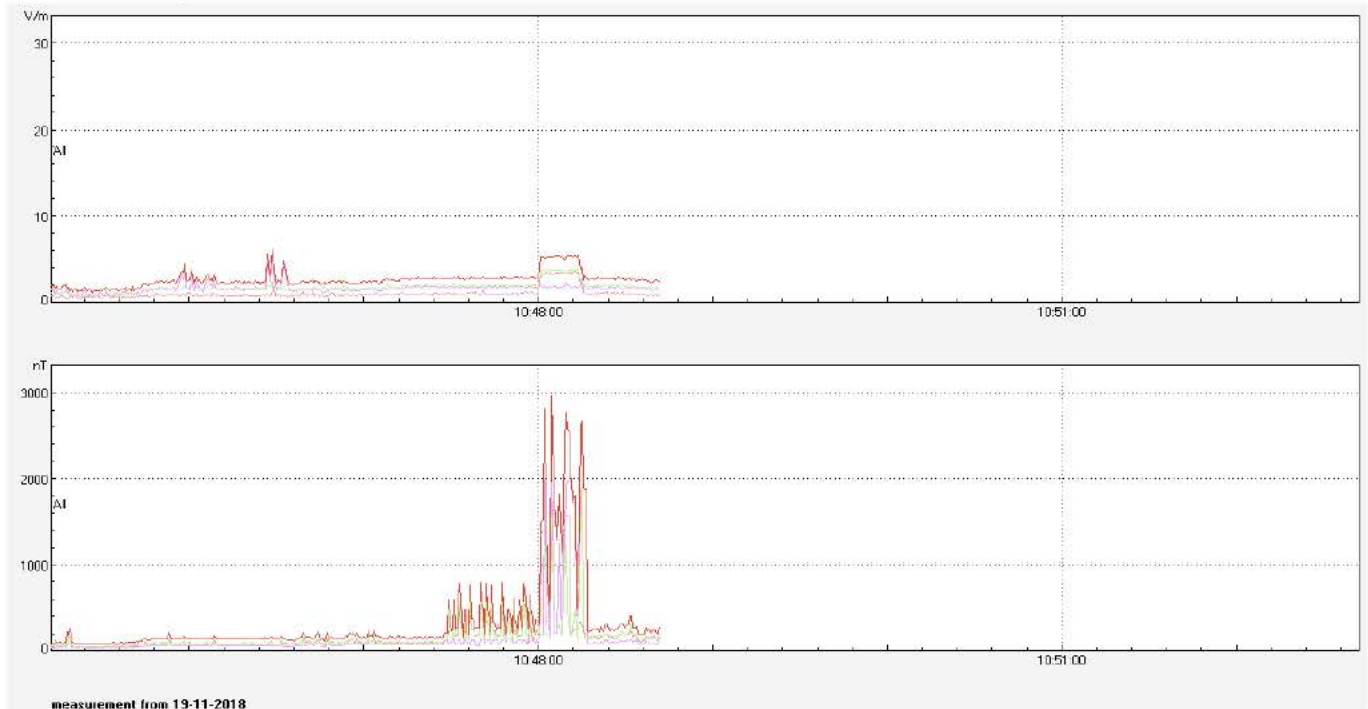

Date & Time	Direction	Operating condition / Train type	Train serial #		Estimated current during test [A]		Distance to track [m]	Height - sensor [m]	Remark
			1	2	Min	Max			
2018/11/19 10:34	W => O	Transit-IC / DDZ	7637	---	-66	132	1.25	1	P-2

Current data:

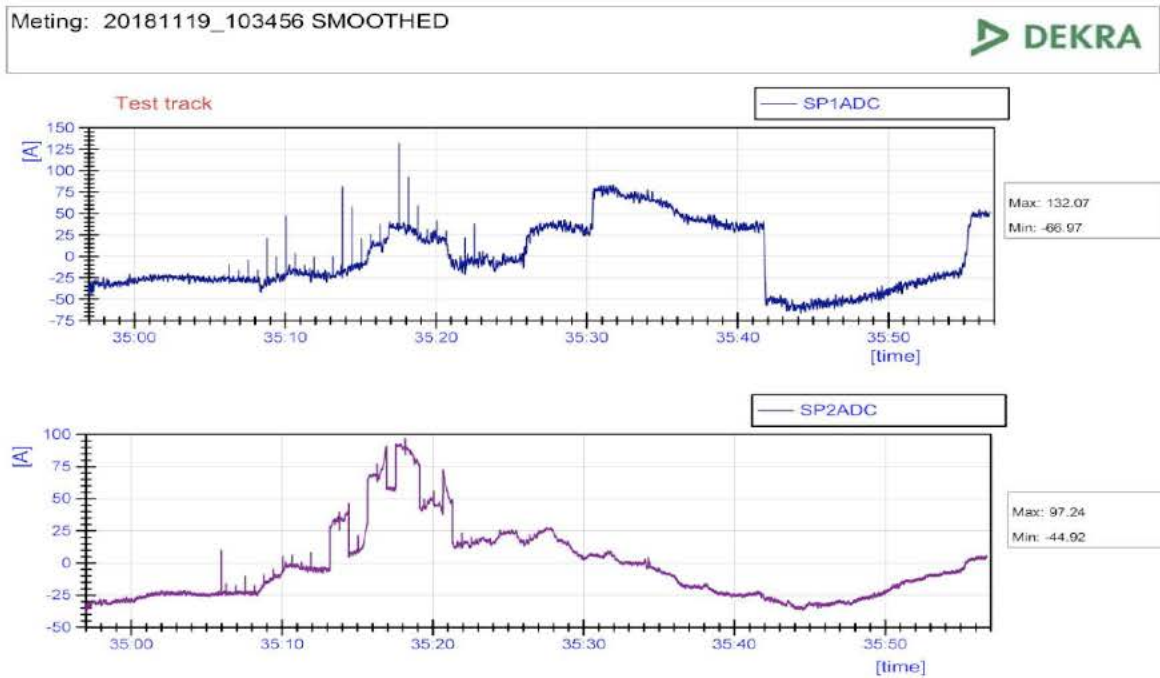

Measurement graphic:

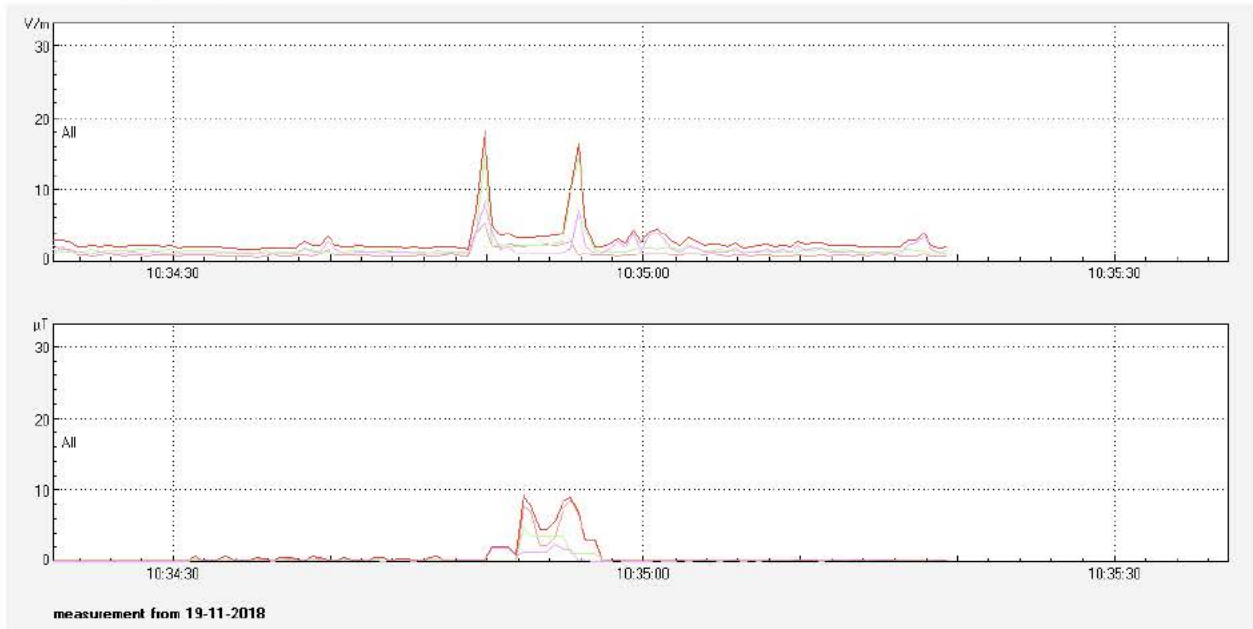

A2.4 Stoptrain (acceleration)/ Transit / Braking, h=0.3 m., d=3 m. (5 Hz – 400 KHz)

Date & Time	Direction	Operating condition / Train type	Train serial #		Estimated current during test [A]		Distance to track [m]	Height - sensor [m]	Remark
			1	2	Min	Max			
2018/11/20 14:48	W => O	Stoptrain / Flirt	2209	2510	-612	637	3	0.3	P-3

Current data:

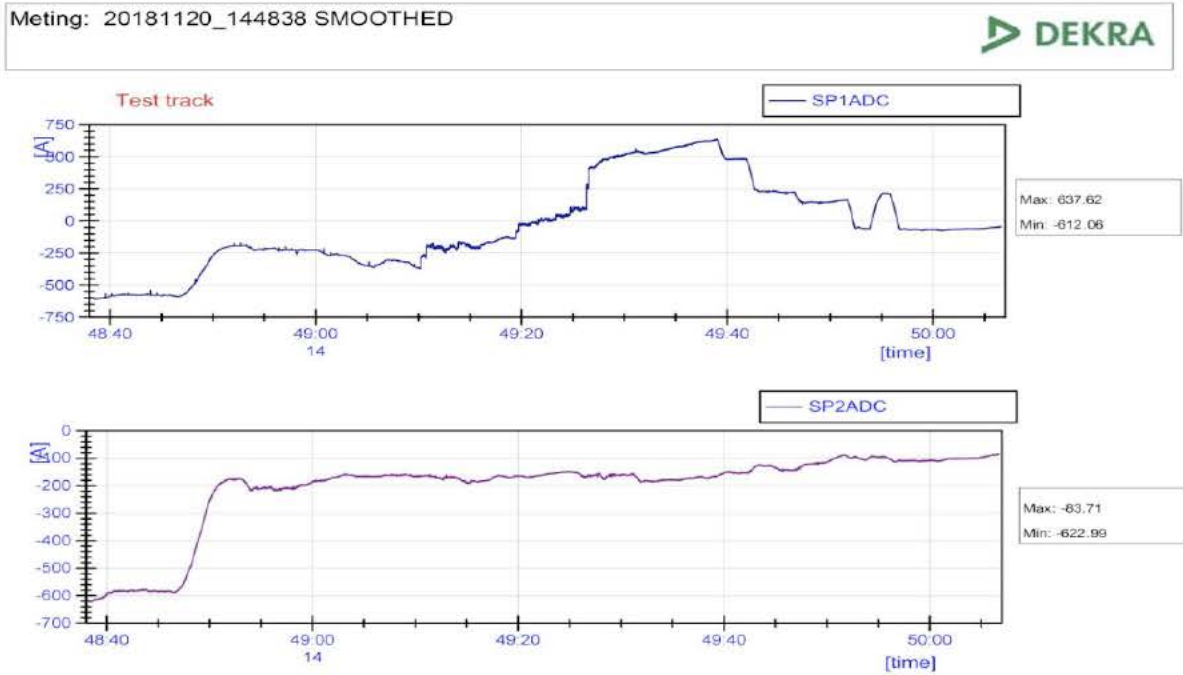

Measurement graphic:

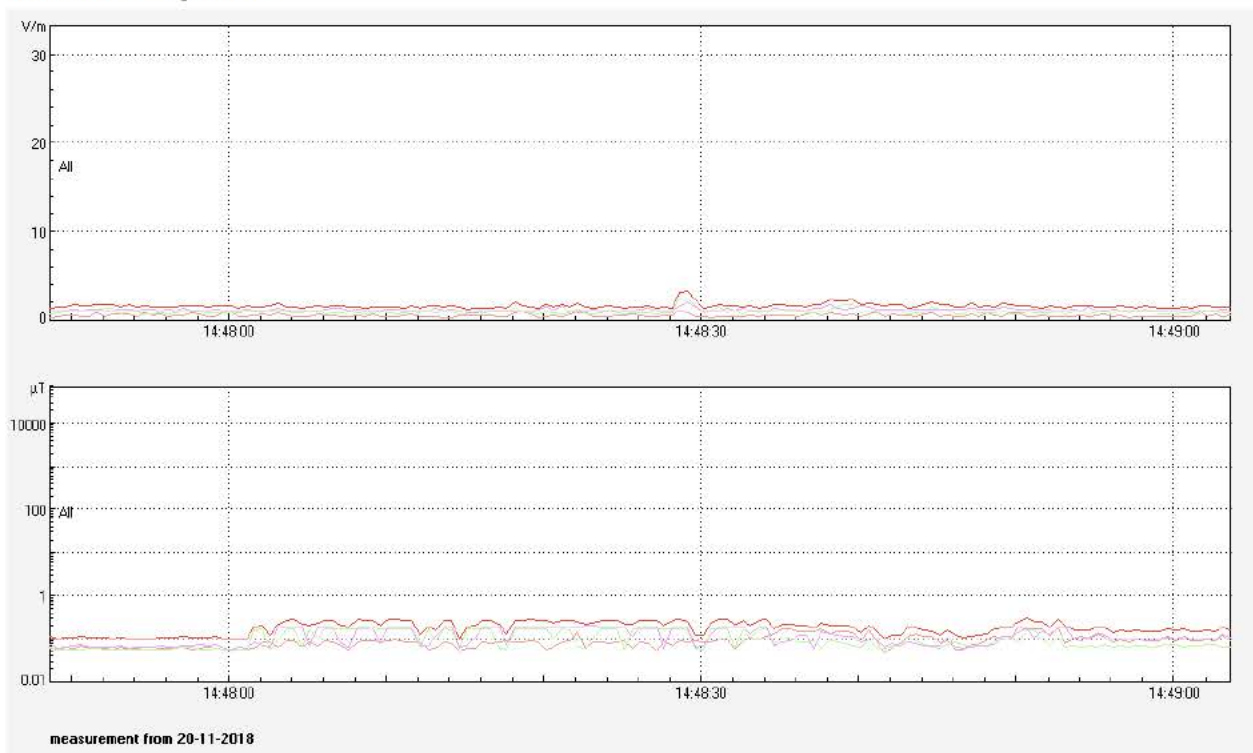

Date & Time	Direction	Operating condition / Train type	Train serial #		Estimated current during test [A]		Distance to track [m]	Height - sensor [m]	Remark
			1	2	Min	Max			
2018/11/20 12:04	W => O	Transit-IC / ICM	4247	--	-56	21	3	0.3	P-3

Current data:

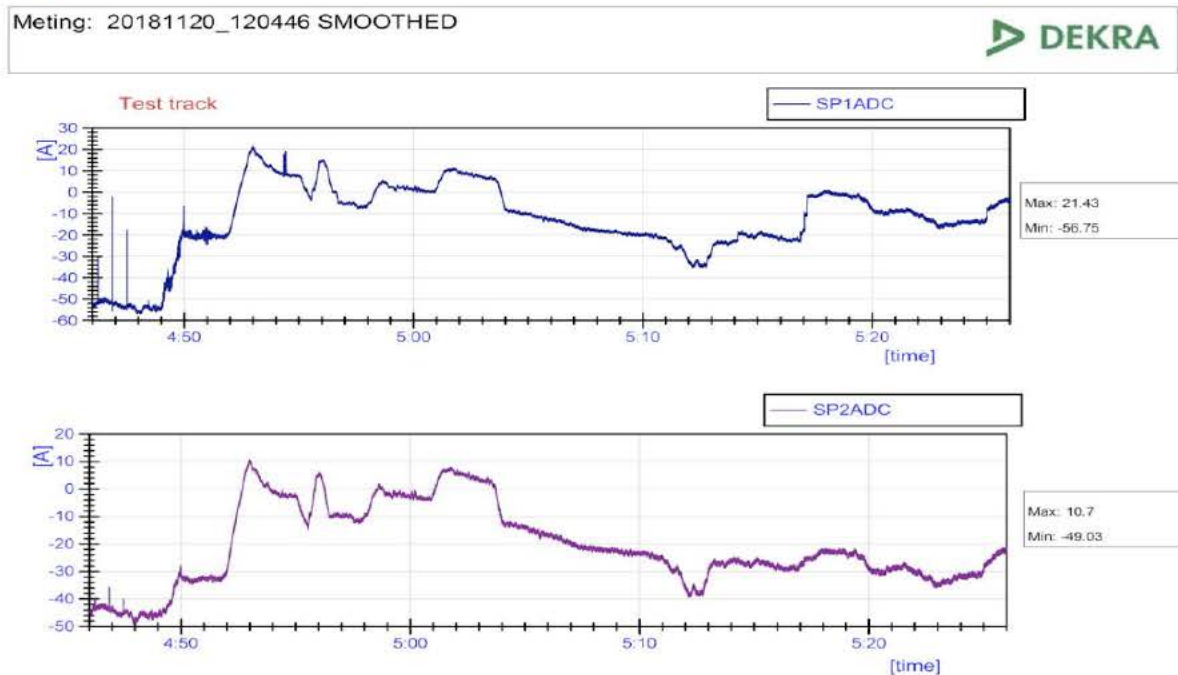

Measurement graphic:

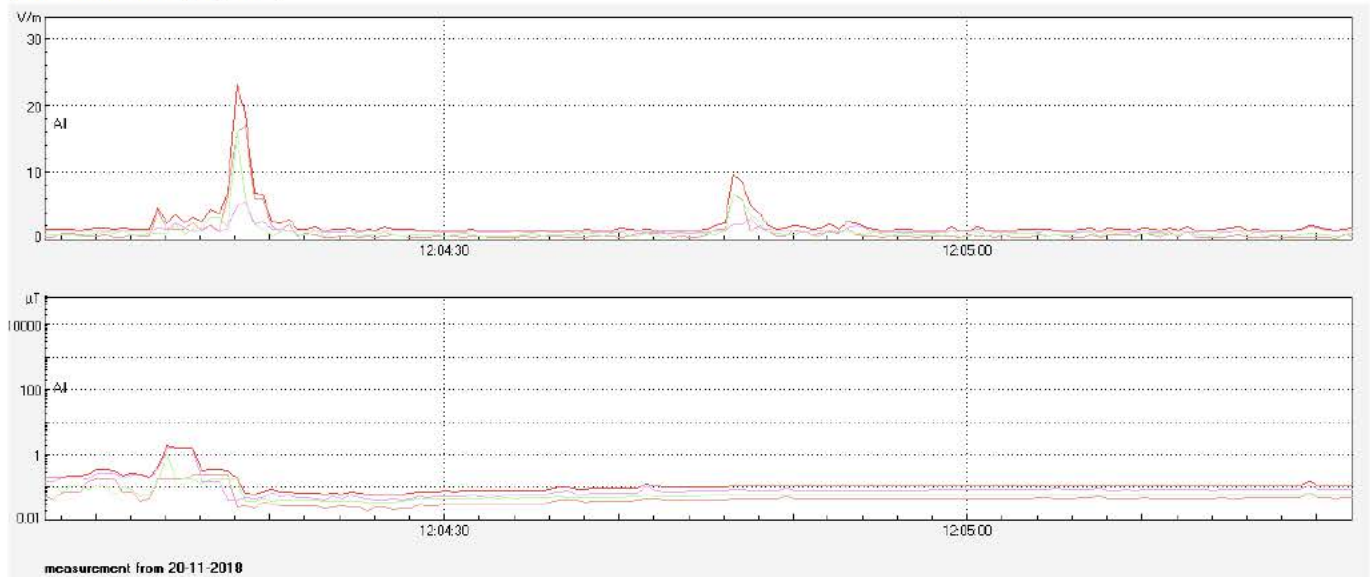

A2.5 Stoptrain (acceleration)/ Transit / Braking, h=1 m., d=3 m. (5 Hz – 400 KHz)

Date & Time	Direction	Operating condition / Train type	Train serial #		Estimated current during test [A]		Distance to track [m]	Height - sensor [m]	Remark
			1	2	Min	Max			
2018/11/20 10:19	W => O	Stoptrain / Flirt	2510	2209	-354	847	3	1	P-3

Current data:

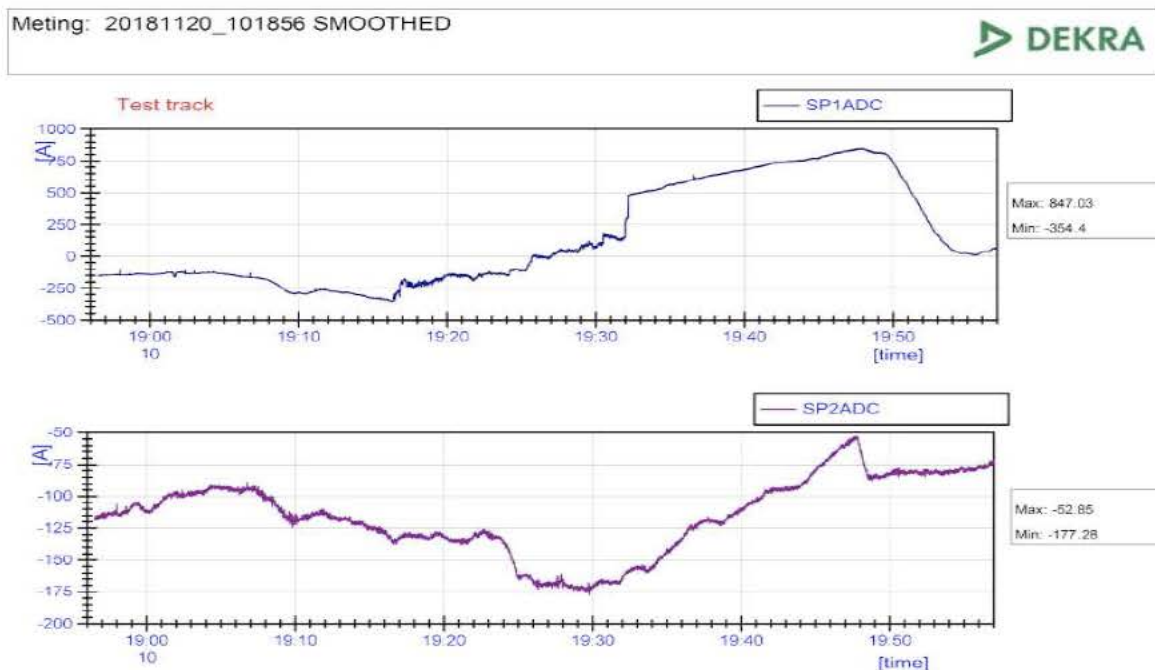

Measurement graphic:

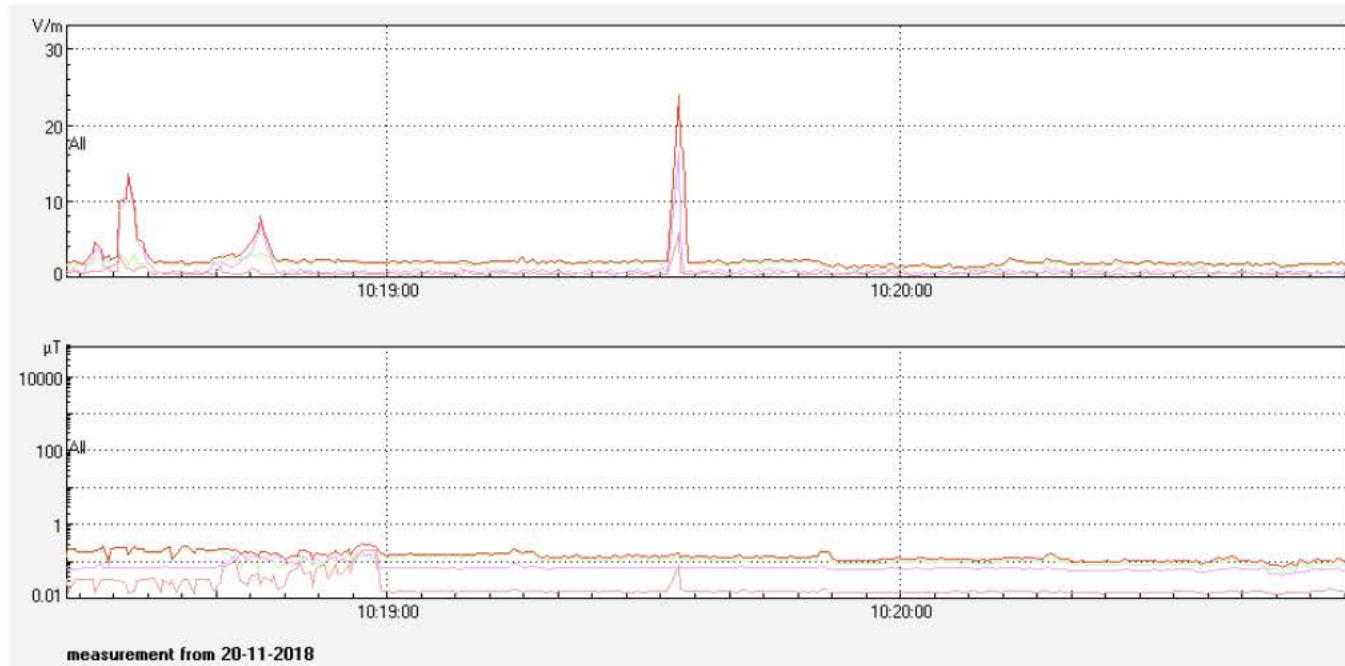

Date & Time	Direction	Operating condition / Train type	Train serial #		Estimated current during test [A]		Distance to track [m]	Height - sensor [m]	Remark
			1	2	Min	Max			
2018/11/20 10:34	W => O	Transit-IC / DDZ	7635	---	-354	847	3	1	P-3

Current data:

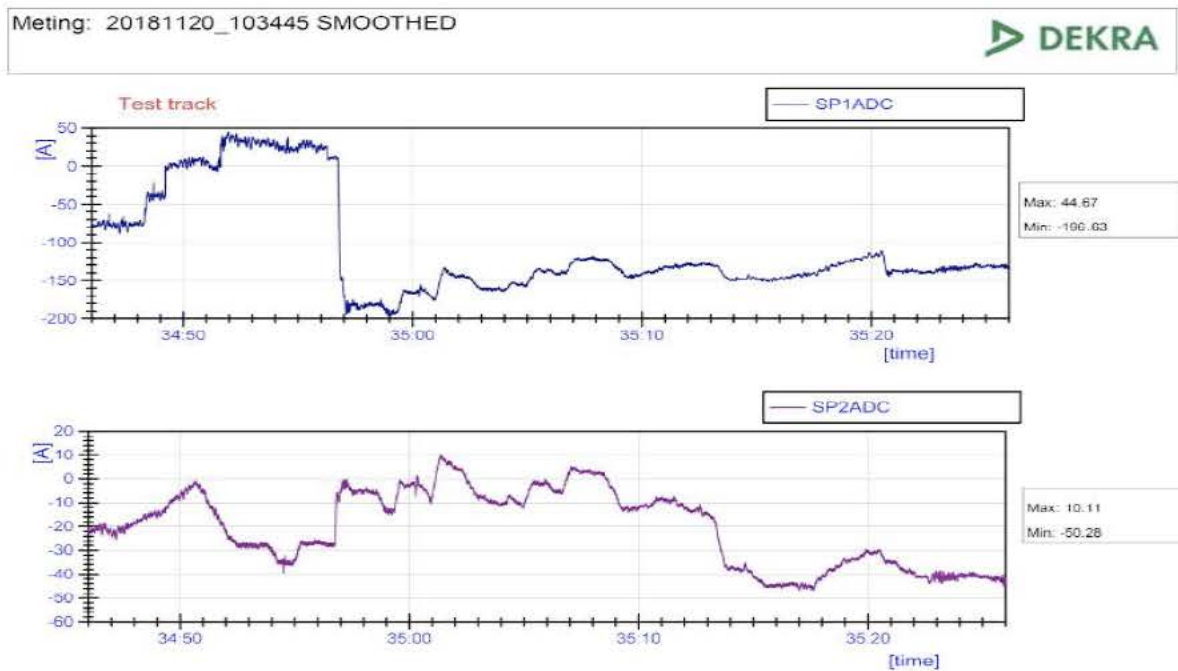

Measurement graphic:

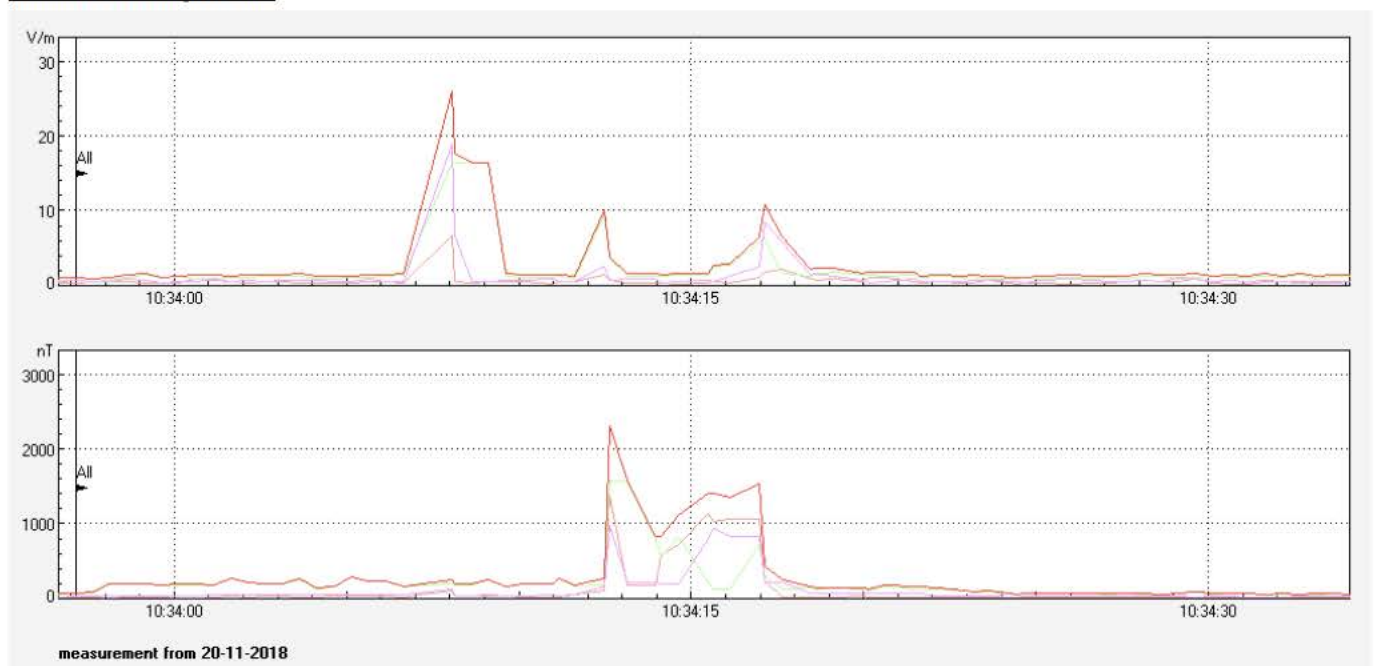

A2.6 Stoptrain (acceleration)/ Transit / Braking, h=1.5 m., d=6 m. (5 Hz – 400 KHz)

The data given in this section has been obtained by doing long term (longer than 30 minutes) measurements. The measurement data (EM field level) has been recorded continuously during stoptrains, transit trains and braking trains on track SP2ADC. The current data given below is the highest current measured during this period.

Date & Time	Direction	Operating condition / Train type	Train serial #		Estimated current during test [A]		Distance to track [m]	Height - sensor [m]	Remark
			1	2	Min	Max			
2018/11/21 15:48	W => O	Stoptrain / Flirt	2506	2208	-569	1279	6	1.5	P-4

Current data:

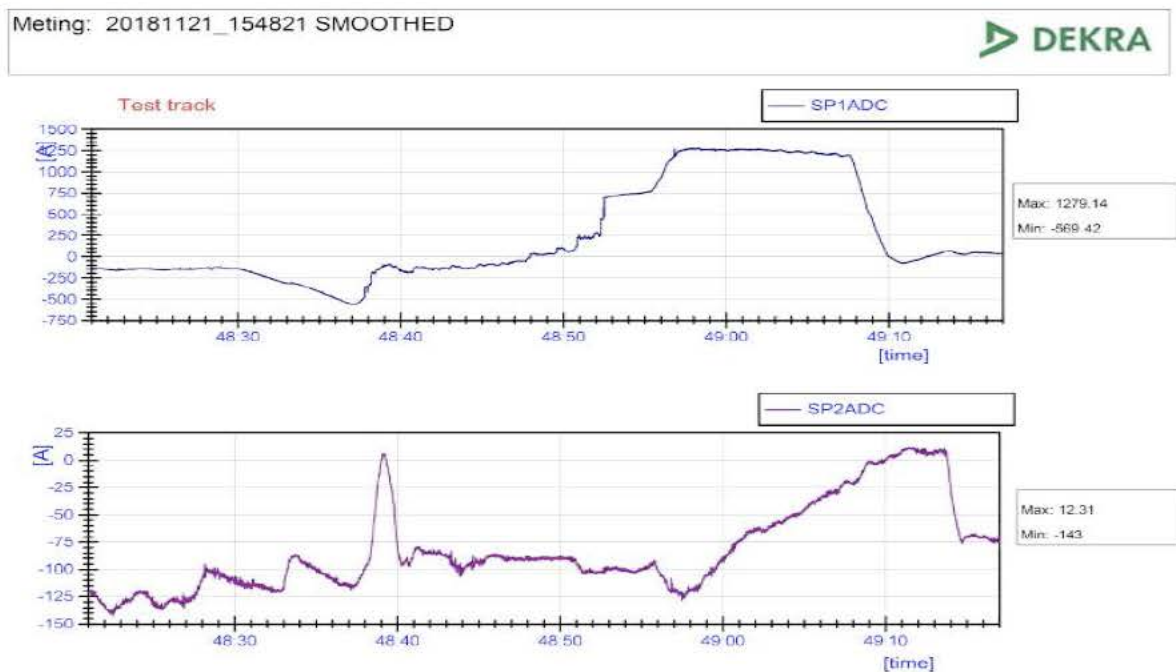

Measurement graphic:

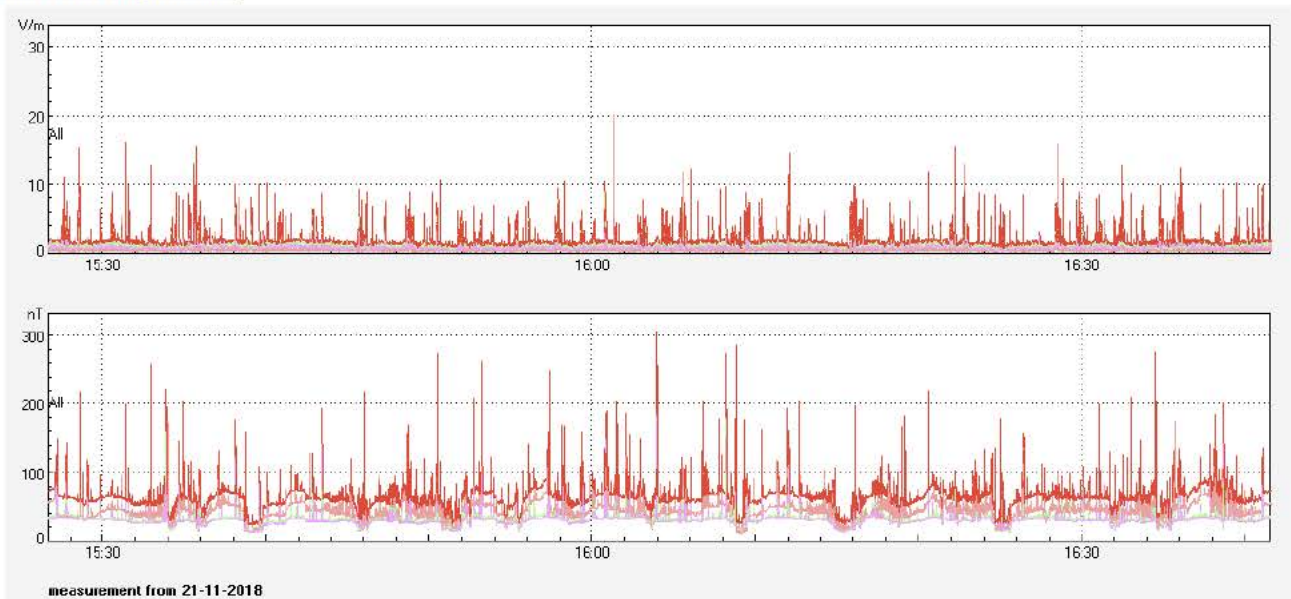

A2.7 Stoptrain (acceleration)/ Transit / Braking, h=1 m., d=10 m. (5 Hz – 400 KHz)

The data given in this section has been obtained by doing long term (longer than 30 minutes) measurements. The measurement data (EM field level) has been recorded continuously during stoptrains, transit trains and braking trains on track SP2ADC. The current data given below is the highest current measured during this period.

Date & Time	Direction	Operating condition / Train type	Train serial #		Estimated current during test [A]		Distance to track [m]	Height - sensor [m]	Remark
			1	2	Min	Max			
2018/11/23 15:47	W => O	Stoptrain / Flirt	2508	2229	-569	1279	10	1	P-5

Current data:

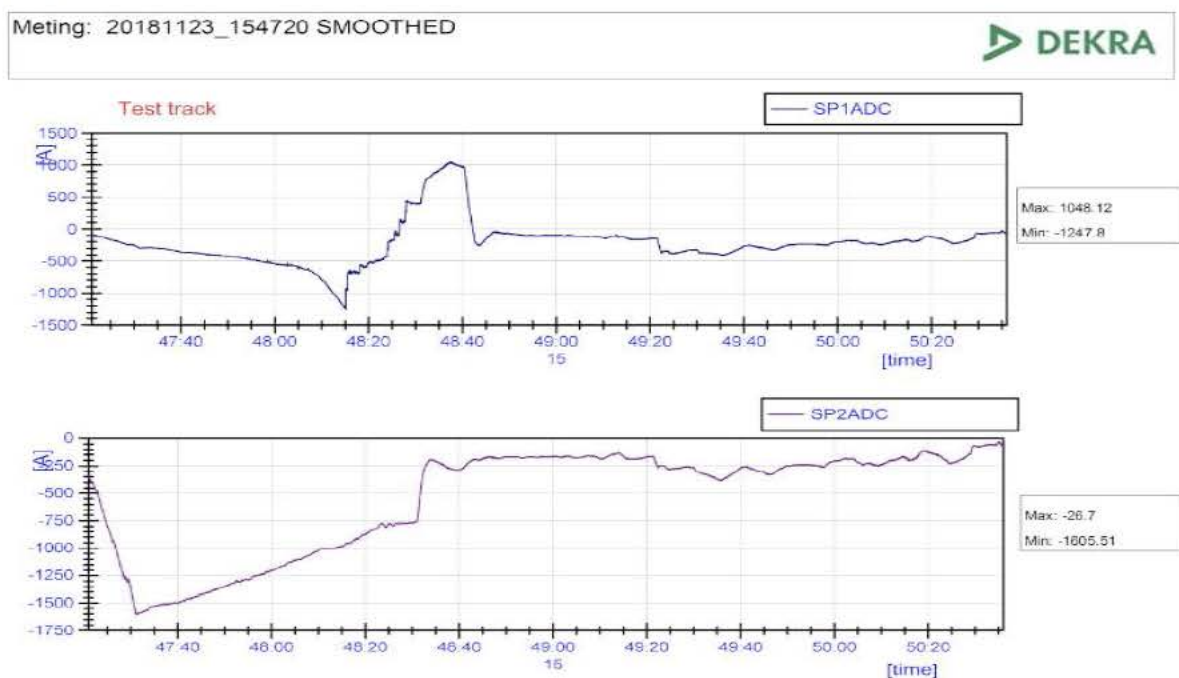

Measurement graphic:

These lines show the position where the measurements have been paused.



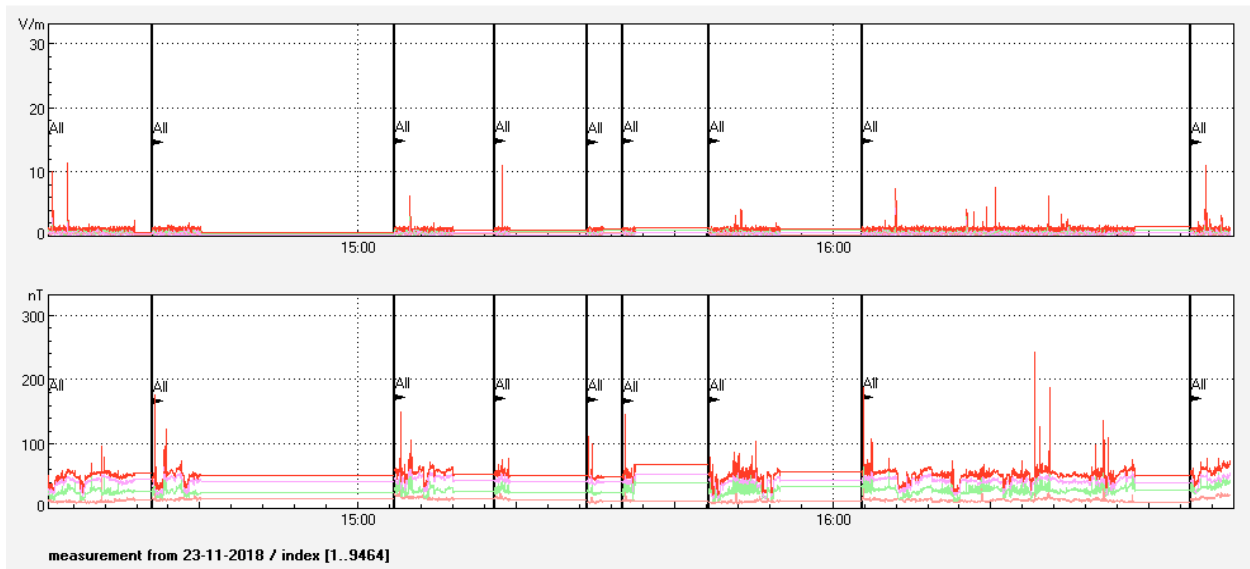

A2.8 Stoptrain (acceleration)/ Transit / Braking, h=1 m., d=30 m. (5 Hz – 400 KHz)

The data given in this section has been obtained by doing long term (longer than 30 minutes) measurements. The measurement data (EM field level) has been recorded continuously during stoptrains, transit trains and braking trains on track SP2ADC. The current data given below is the highest current measured during this period.

Date & Time	Direction	Operating condition / Train type	Train serial #		Estimated current during test [A]		Distance to track [m]	Height - sensor [m]	Remark
			1	2	Min	Max			
2018/11/23 15:47	W => O	Stoptrain / Flirt	2217	2516	-644	1282	30	1	P-6

Current data:

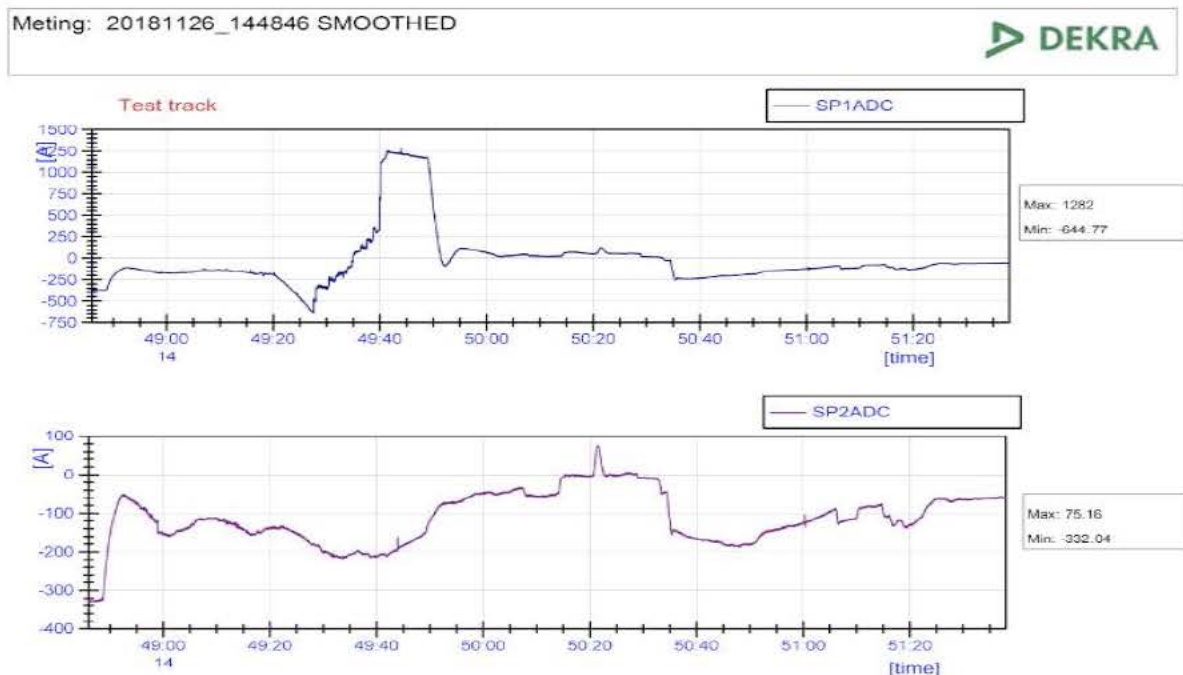

Measurement graphic:

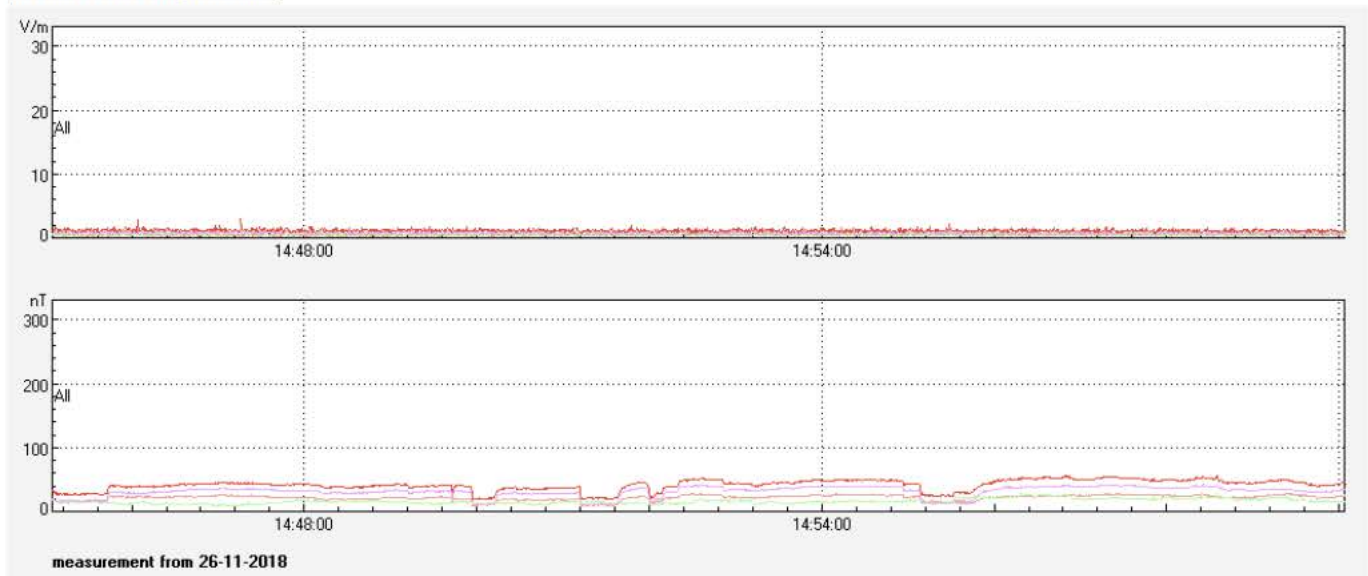

A2.9 Barrier system, $h=1.55$ m., $d=0$ m. and $d=1$ m. (5 Hz – 400 KHz)

The data given in this section belongs to the barrier system. The measurement data has been recorded continuously when the barrier was closed as well as when the barrier was changing state (Close→Open, Open→Close).

Measurement graphic at $h=1.55$ m. and $d=0$ m.:

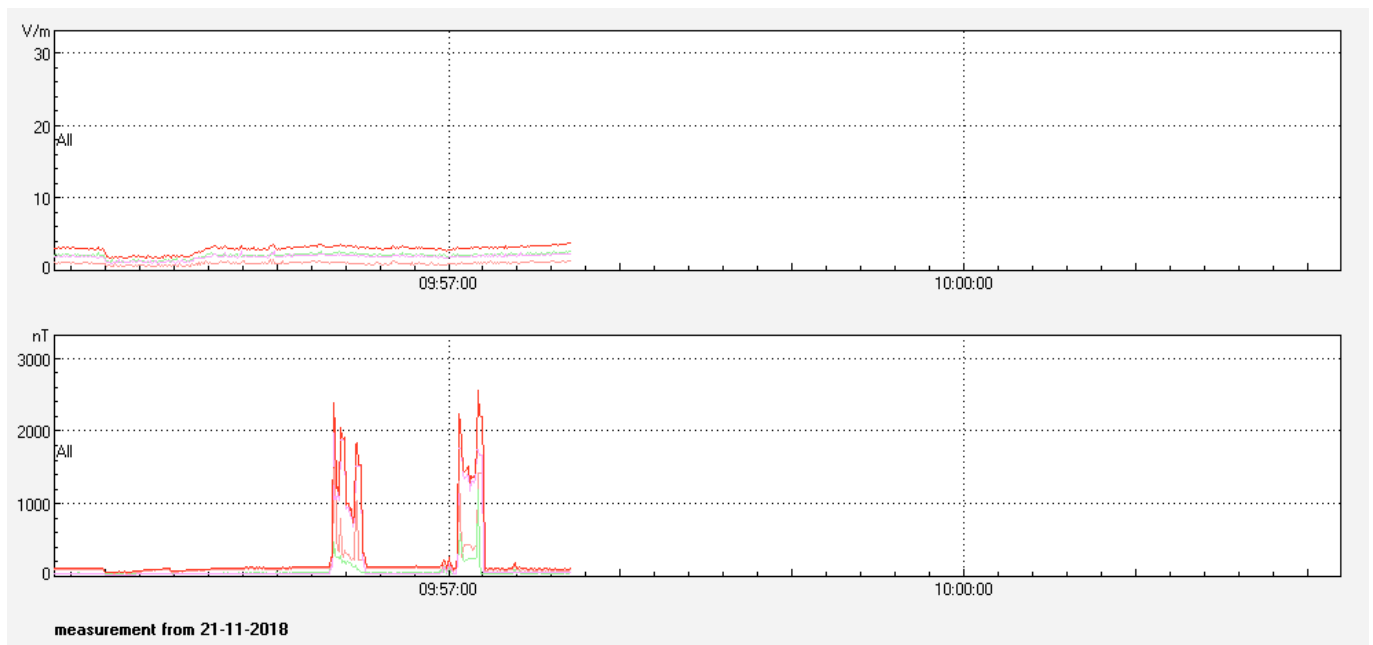
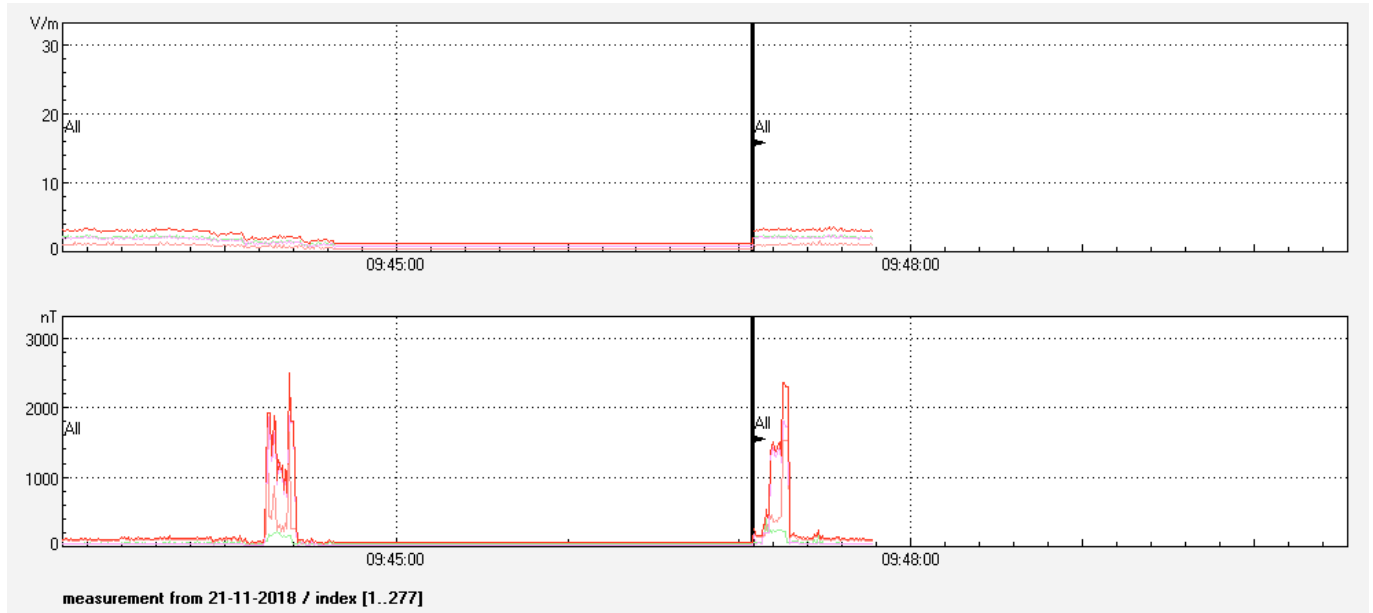

Measurement graphic at h=1.55 m. and d=1 m.:

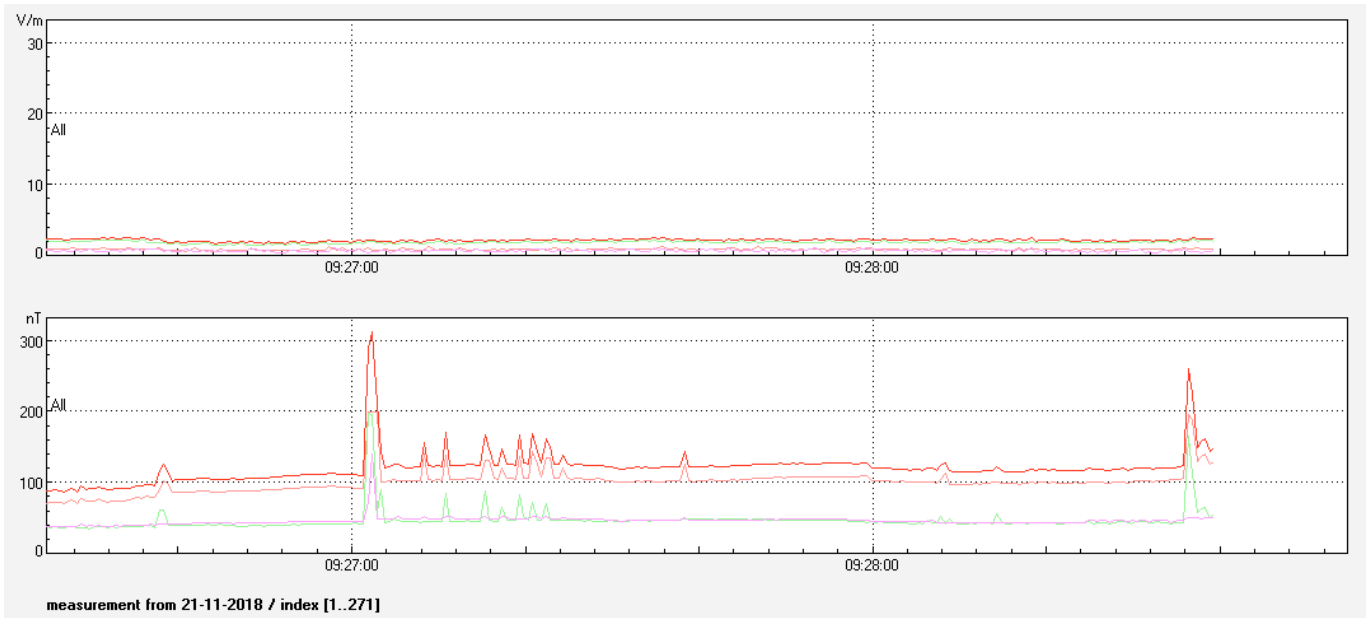
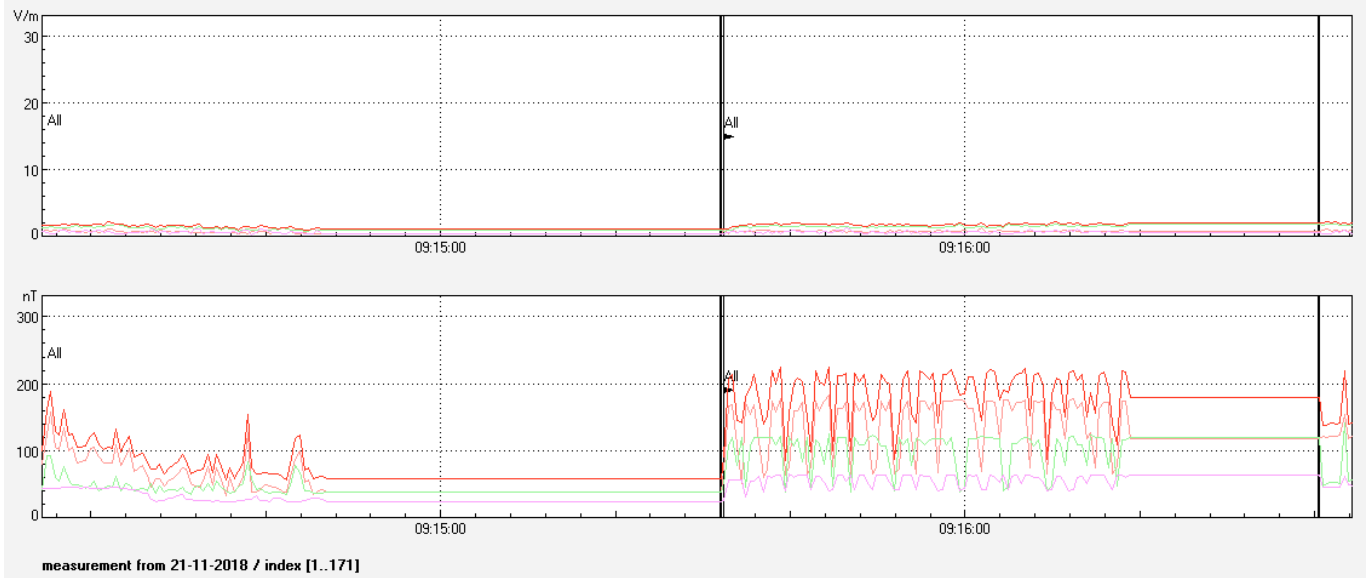

A2.10 Stoptrain (acceleration)/ Transit / Braking, h=0.5 m., d=1.25 m. (9 KHz - 30 MHz)

Frequency range	Date & Time	Direction	Operating condition / Train type	Train serial #		Estimated current during test [A]		Distance to track [m]	Height - sensor [m]	Remark
				1	2	Min	Max			
9 KHz-150 KHz	2018/11/19 14:48	W => O	Stoptrain / Flirt	2209	2510	-404	1141	1.25	0.5	P-2, X-axis
150 KHz-30 MHz	2018/11/19 10:47	W => O	Stoptrain / Flirt	2224	---	-710	591	1.25	0.5	P-2, X-axis

Measurement graphic (X-axis):

Subrange	Step Size	Detectors	Bandwidth	Sweep Time	Preamp
9 kHz - 150 kHz	14.1 Hz	PK+	200 Hz	Coupled	0 dB
150 kHz - 30 MHz	2.985 kHz	PK+	9 kHz	Coupled	20 dB

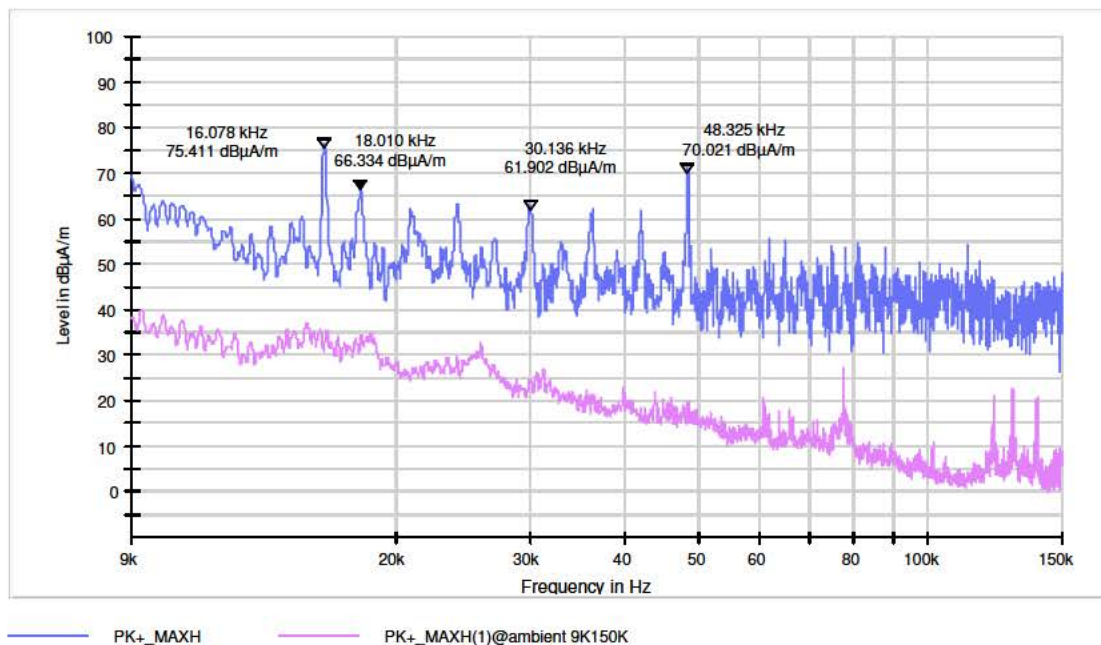

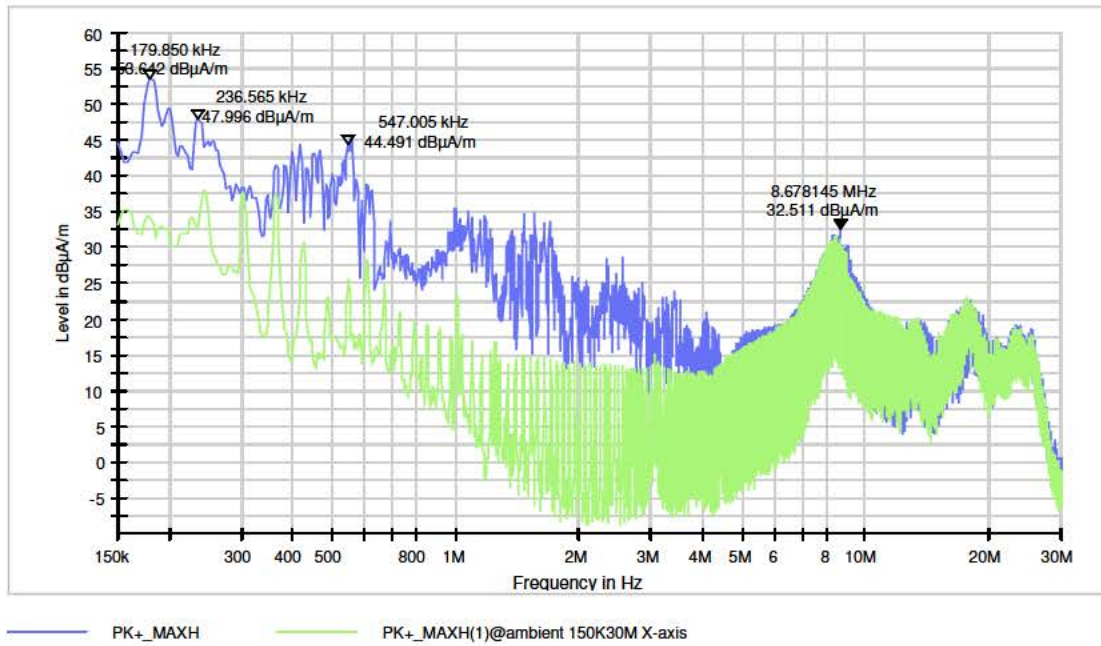

Frequency range	Date & Time	Direction	Operating condition / Train type	Train serial #		Estimated current during test [A]		Distance to track [m]	Height - sensor [m]	Remark
				1	2	Min	Max			
9 KHz-150 KHz	2018/11/19 15:04	W => O	Transit (IC) / DDZ	7618	---	-160	30	1.25	0.5	P-2, X-axis
150 KHz-30 MHz	2018/11/19 11:05	W => O	Transit (IC) / DDZ	7612	---	-200	130	1.25	0.5	P-2, X-axis

Measurement graphic (X-axis):

Subrange	Step Size	Detectors	Bandwidth	Sweep Time	Preamp
9 kHz - 150 kHz	14.1 Hz	PK+	200 Hz	Coupled	0 dB
150 kHz - 30 MHz	2.985 kHz	PK+	9 kHz	Coupled	20 dB

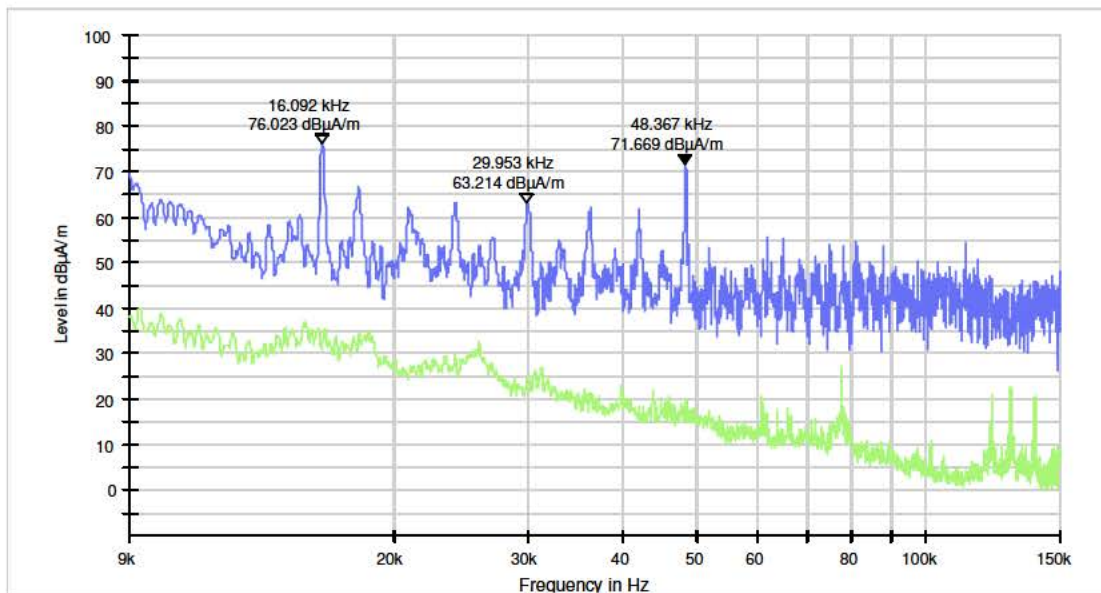

PK+_MAXH PK+_MAXH(1)@ambient 9K150K

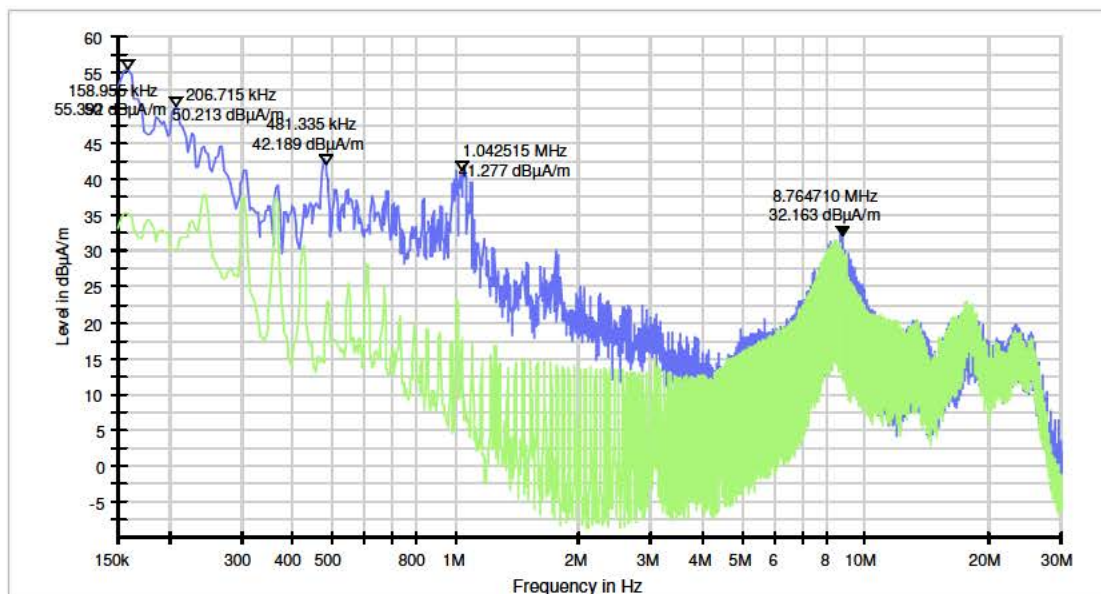

PK+_MAXH PK+_MAXH(1)@ambient 150K30M X-axis

Frequency range	Date & Time	Direction	Operating condition / Train type	Train serial #		Estimated current during test [A]		Distance to track [m]	Height - sensor [m]	Remark
				1	2	Min	Max			
9 KHz-150 KHz	2018/11/19 16:27	W => O	Stoptrain / Flirt	3523	2513	-250	130	1.25	0.5	P-2, Y-axis
150 KHz-30 MHz	2018/11/20 09:49	W => O	Stoptrain / Flirt	2219	2504	-450	950	1.25	0.5	P-2, Y-axis

Measurement graphic (Y-axis):

Subrange	Step Size	Detectors	Bandwidth	Sweep Time	Preamp
9 kHz - 150 kHz	14.1 Hz	PK+	200 Hz	Coupled	0 dB
150 kHz - 30 MHz	2.985 kHz	PK+	9 kHz	Coupled	20 dB

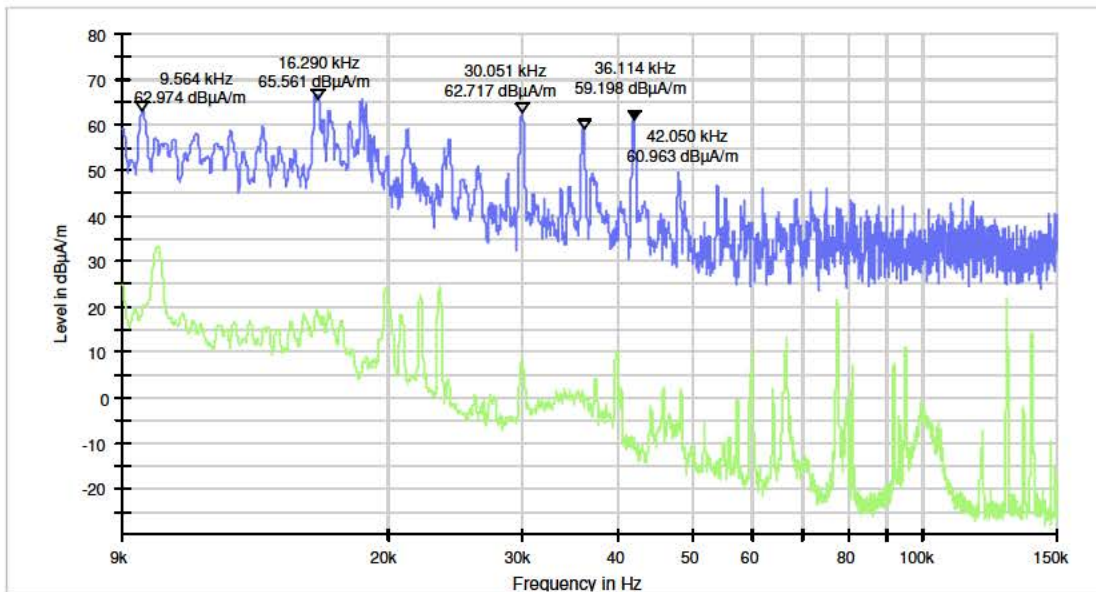

— PK+_MAXH — PK+_MAXH(1)@M3a ambient 9k - 150k

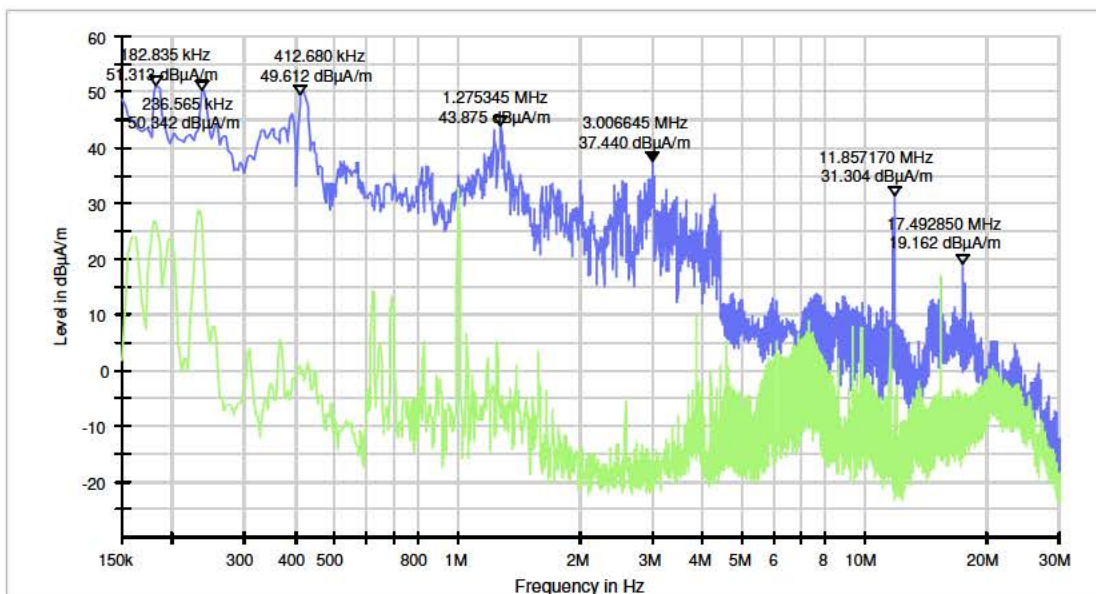

— PK+_MAXH — PK+_MAXH(1)@M2a ambient 150k - 30M

Frequency range	Date & Time	Direction	Operating condition / Train type	Train serial #		Estimated current during test [A]		Distance to track [m]	Height - sensor [m]	Remark
				1	2	Min	Max			
9 KHz-150 KHz	2018/11/19 15:34	W => O	Transit (IC) / DDZ	7620	---	-225	60	1.25	0.5	P-2, Y-axis
150 KHz-30 MHz	2018/11/20 10:34	W => O	Transit (IC) / DDZ	7635	---	-50	60	1.25	0.5	P-2, Y-axis

Measurement graphic (Y-axis):

Subrange 9 kHz - 150 kHz 150 kHz - 30 MHz	Step Size 14.1 Hz 2.985 kHz	Detectors PK+ PK+	Bandwidth 200 Hz 9 kHz	Sweep Time Coupled Coupled	Preamp 0 dB 20 dB
--	--	--------------------------------	-------------------------------------	---	--------------------------------

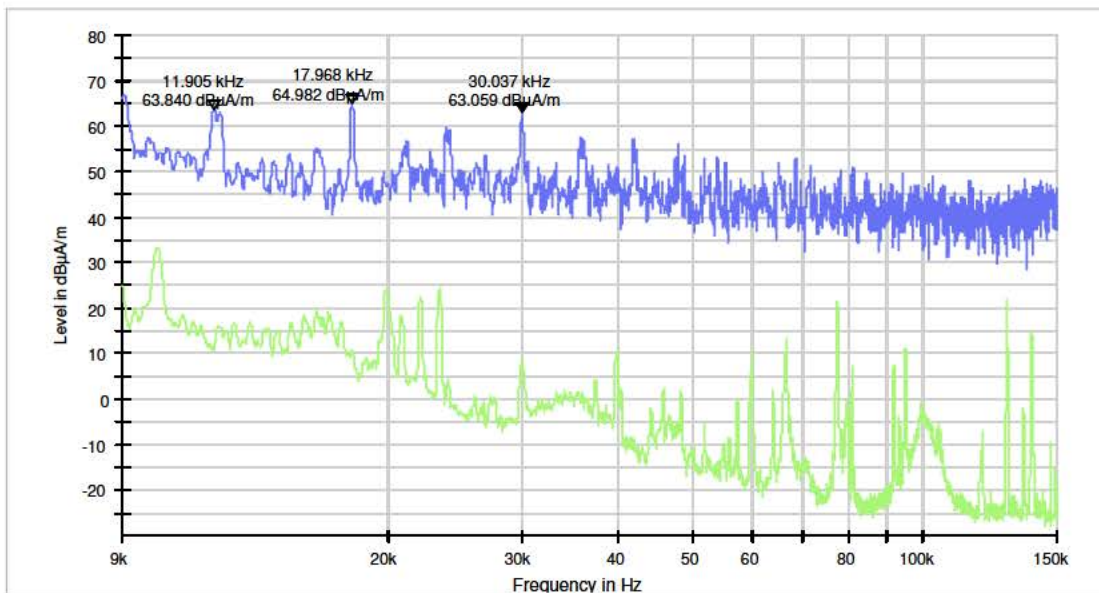

PK+_MAXH PK+_MAXH(1)@M3a ambient 9k - 150k h_100cm d_10m 15.02 Y-axis

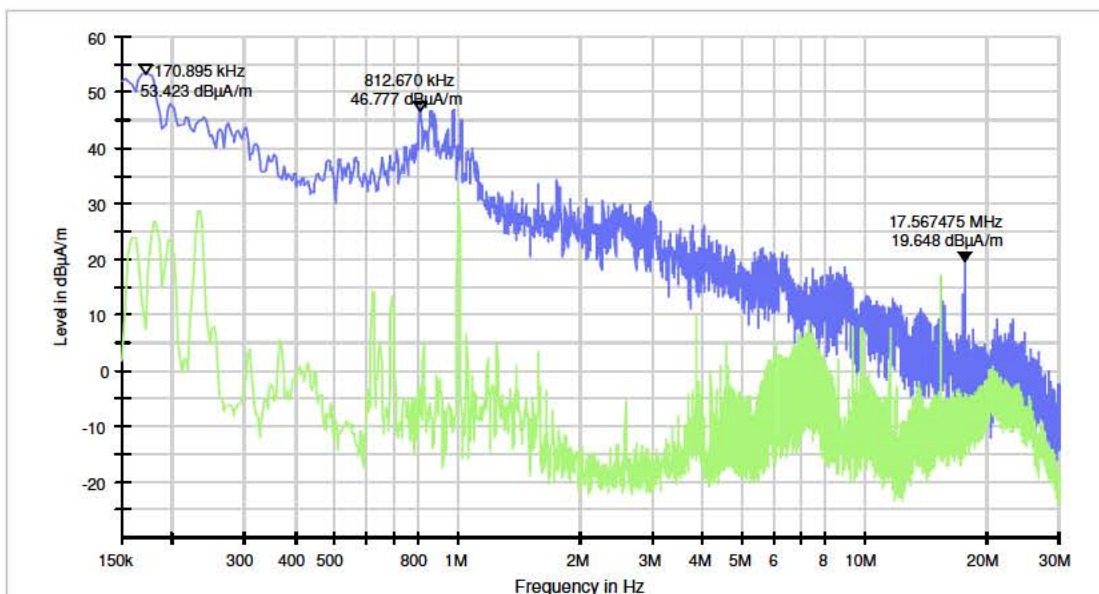

PK+_MAXH PK+_MAXH(1)@Ambient 150k - 30M

Frequency range	Date & Time	Direction	Operating condition / Train type	Train serial #		Estimated current during test [A]		Distance to track [m]	Height - sensor [m]	Remark
				1	2	Min	Max			
9 KHz-150 KHz	2018/11/20 14:48	W => O	Stoptrain / Flirt	2219	2504	-600	650	1.25	0.5	P-2, Z-axis
150 KHz-30 MHz	2018/11/20 12:48	W => O	Stoptrain / Flirt	2507	2211	-150	450	1.25	0.5	P-2, Z-axis

Measurement graphic (Z-axis):

Subrange	Step Size	Detectors	Bandwidth	Sweep Time	Preamp
9 kHz - 150 kHz	14.1 Hz	PK+	200 Hz	Coupled	0 dB
150 kHz - 30 MHz	2.985 kHz	PK+	9 kHz	Coupled	20 dB

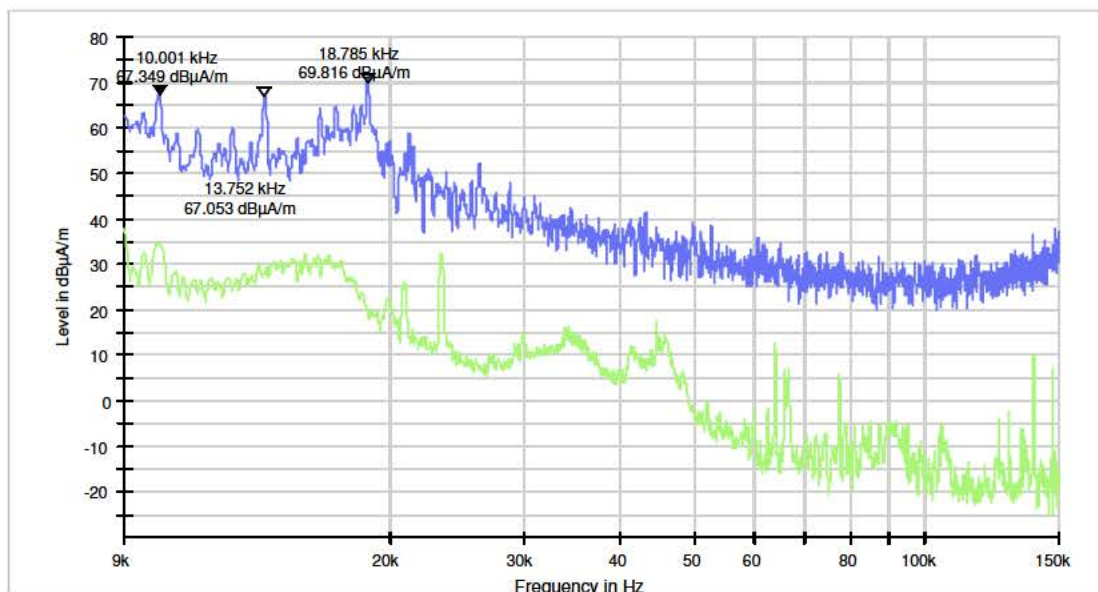

— PK+_MAXH — PK+_MAXH(1)@Ambient 9k-150k

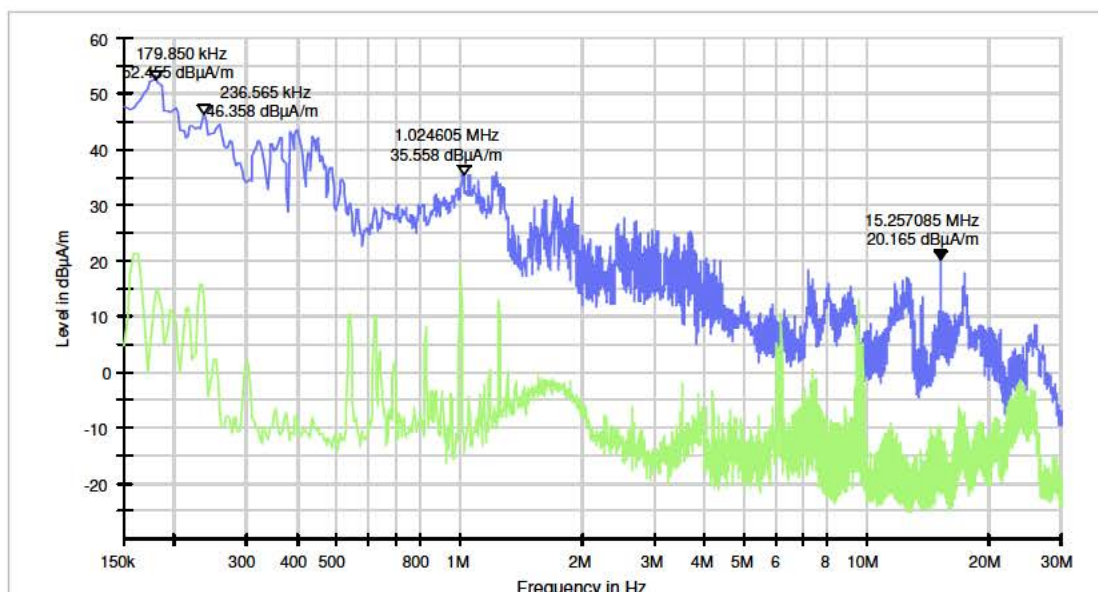

— PK+_MAXH — PK+_MAXH(1)@Ambient 150k - 30M

Frequency range	Date & Time	Direction	Operating condition / Train type	Train serial #		Estimated current during test [A]		Distance to track [m]	Height - sensor [m]	Remark
				1	2	Min	Max			
9 KHz-150 KHz	2018/11/20 15:04	W => O	Transit (IC) / DDZ	7618	---	-300	90	1.25	0.5	P-2, Z-axis
150 KHz-30 MHz	2018/11/20 11:35	W => O	Transit (IC) / DDZ	7620	---	-200	300	1.25	0.5	P-2, Z-axis

Measurement graphic (Z-axis):

Subrange	Step Size	Detectors	Bandwidth	Sweep Time	Preamp
9 kHz - 150 kHz	14.1 Hz	PK+	200 Hz	Coupled	0 dB
150 kHz - 30 MHz	2.985 kHz	PK+	9 kHz	Coupled	20 dB

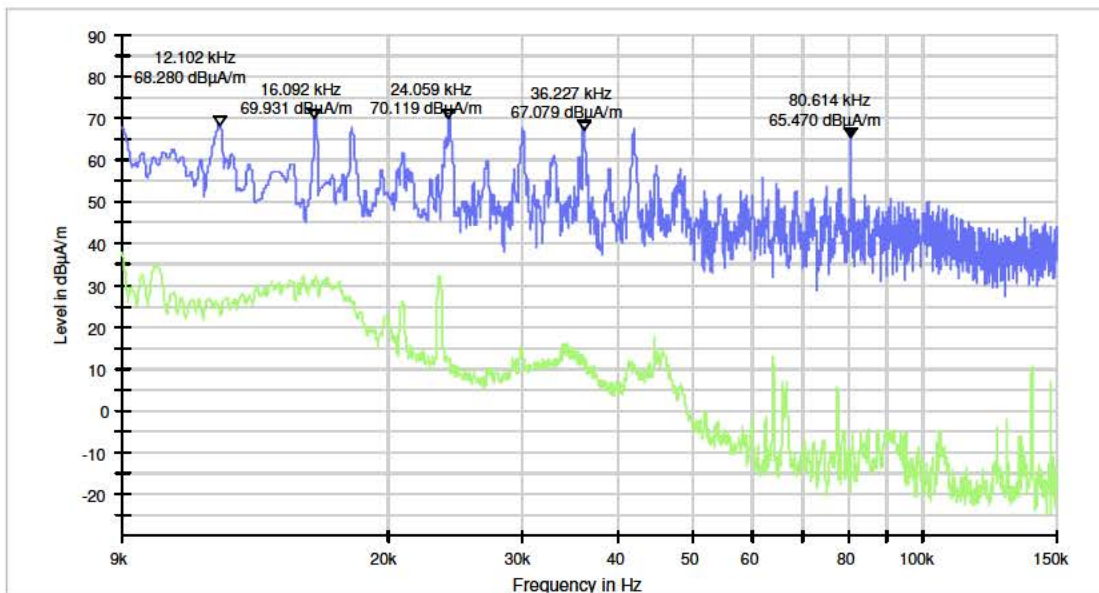

— PK+_MAXH — PK+_MAXH(1)@Ambient 9k-150K

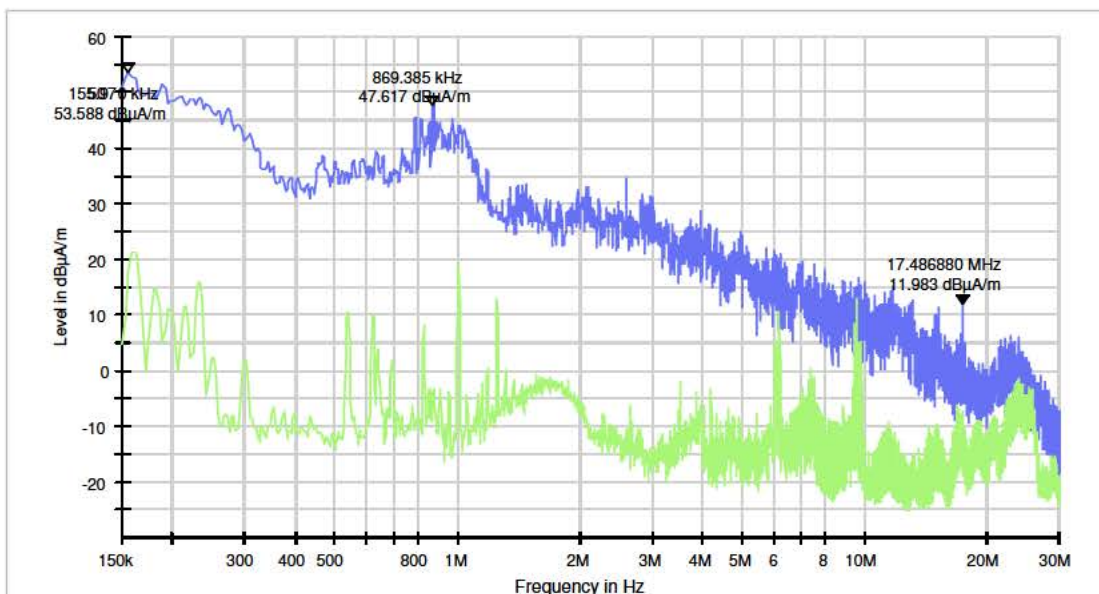

— PK+_MAXH — PK+_MAXH(1)@Ambient 150k - 30M

A2.11 Stoptrain (acceleration)/ Transit / Braking, h=1 m., d=1.25 m. (9 KHz - 30 MHz)

Frequency range	Date & Time	Direction	Operating condition / Train type	Train serial #		Estimated current during test [A]		Distance to track [m]	Height - sensor [m]	Remark
				1	2	Min	Max			
9 KHz-150 KHz	2018/11/21 10:19	W => O	Stoptrain / Flirt	2219	2504	-510	890	1.25	1	P-2, X-axis
150 KHz-30 MHz	2018/11/21 10:49	W => O	Stoptrain / Flirt	2506	2208	-200	1370	1.25	1	P-2, X-axis ¹⁾

¹⁾ Acceleration train on track SP1ADC and braking train on track SP2ADC.

Measurement graphic (X-axis):

Subrange	Step Size	Detectors	Bandwidth	Sweep Time	Preamp
9 kHz - 150 kHz	14.1 Hz	PK+	200 Hz	Coupled	0 dB
150 kHz - 30 MHz	2.985 kHz	PK+	9 kHz	Coupled	20 dB

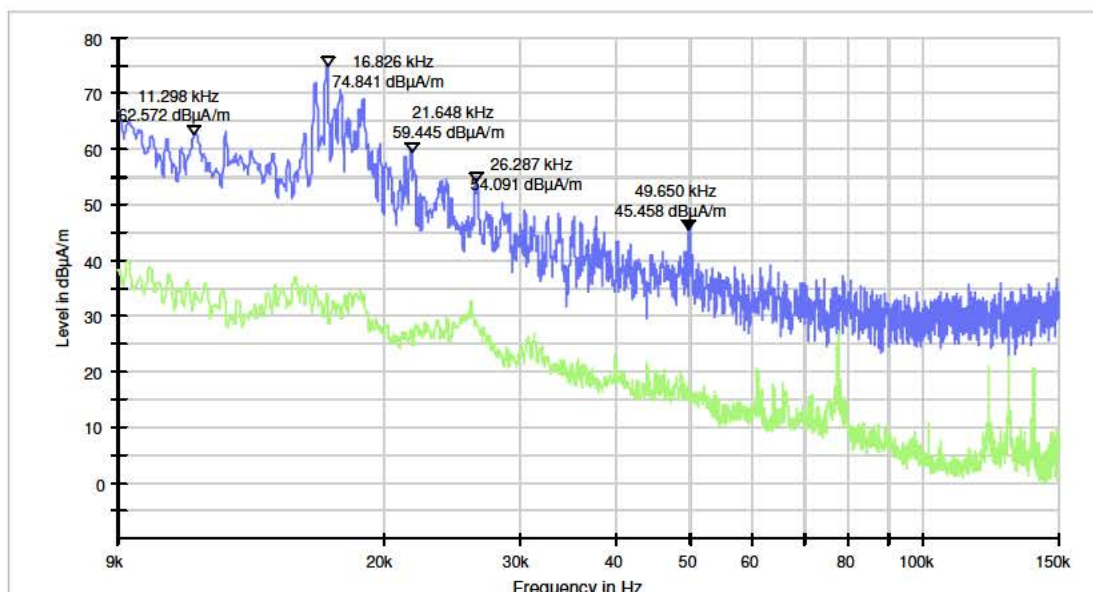

PK+_MAXH PK+_MAXH(1)@Ambient 9K150K

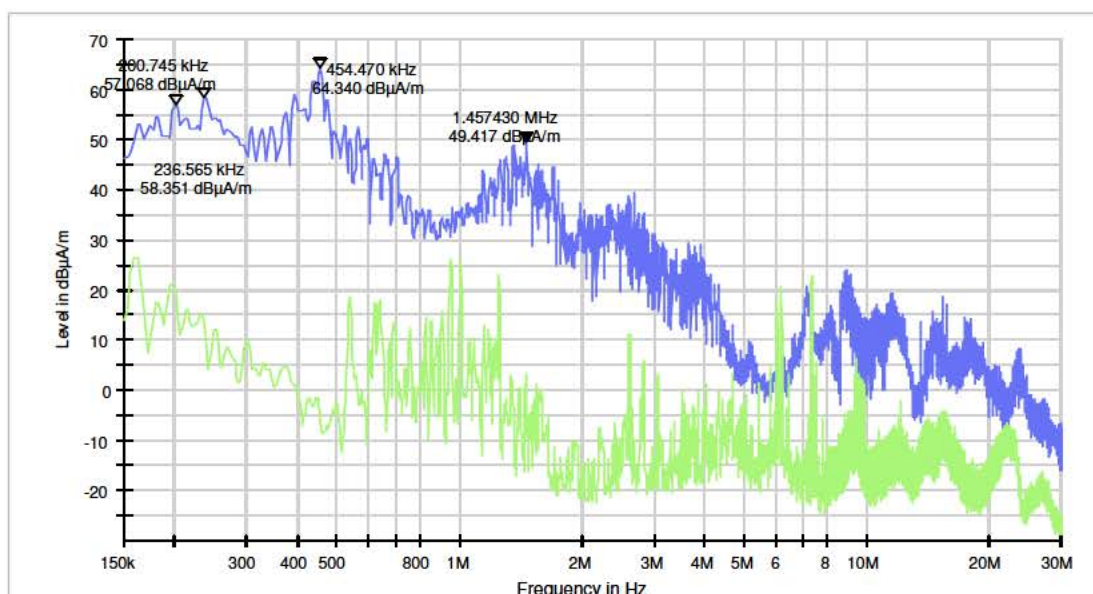

PK+_MAXH PK+_MAXH(1)@Ambient

Frequency range	Date & Time	Direction	Operating condition / Train type	Train serial #		Estimated current during test [A]		Distance to track [m]	Height - sensor [m]	Remark
				1	2	Min	Max			
9 KHz-150 KHz	2018/11/21 09:02	W => O	Transit (IC) / DDZ	---	---	---	---	1.25	1	P-2, X-axis
150 KHz-30 MHz	2018/11/21 11:05	W => O	Transit (IC) / DDZ	7609	---	-160	100	1.25	1	P-2, X-axis

Measurement graphic (X-axis):

Subrange	Step Size	Detectors	Bandwidth	Sweep Time	Preamp
9 kHz - 150 kHz	14.1 Hz	PK+	200 Hz	Coupled	0 dB
150 kHz - 30 MHz	2.985 kHz	PK+	9 kHz	Coupled	20 dB

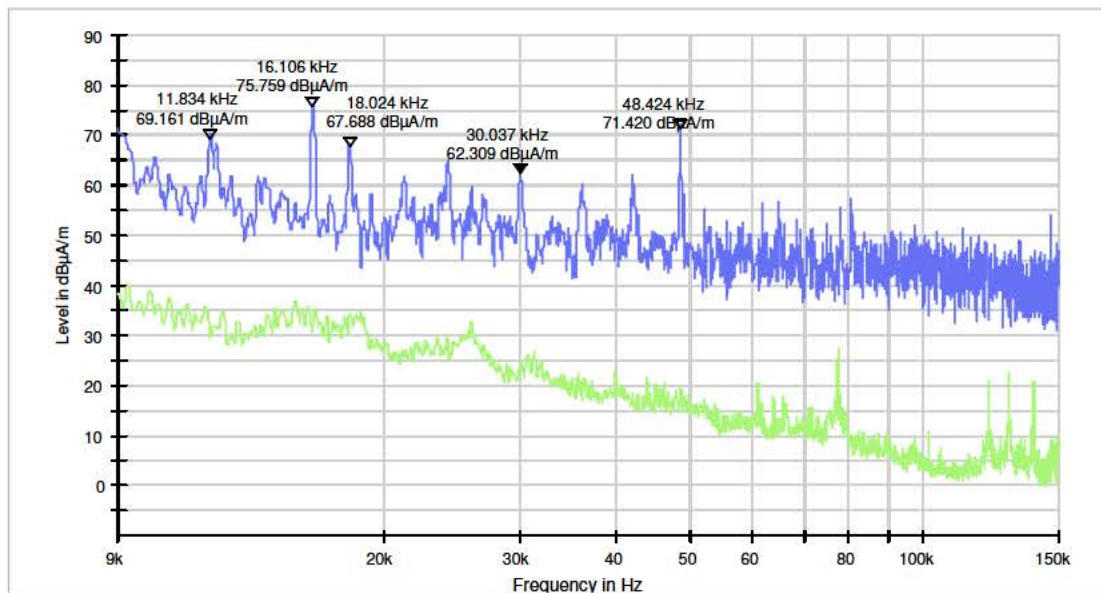

PK+_MAXH PK+_MAXH(1)@Ambient 9K150K

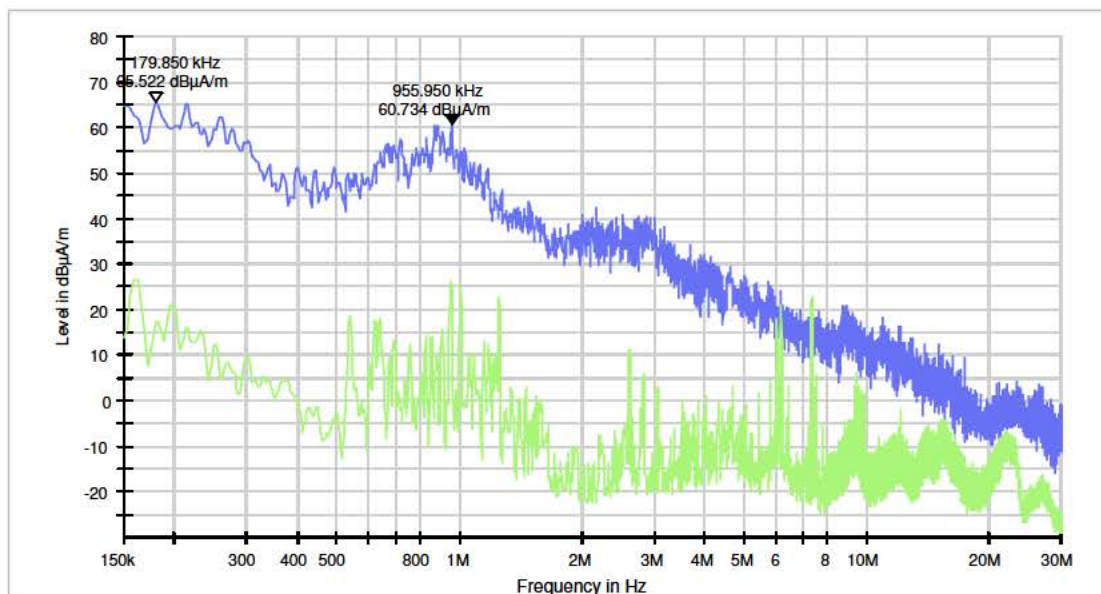

PK+_MAXH PK+_MAXH(1)@Ambient 150K30M

Frequency range	Date & Time	Direction	Operating condition / Train type	Train serial #		Estimated current during test [A]		Distance to track [m]	Height - sensor [m]	Remark
				1	2	Min	Max			
9 KHz-150 KHz	2018/11/21 14:48	W => O	Stoptrain / Flirt	2512	2229	-650	1011	1.25	1	P-2, Y-axis
150 KHz-30 MHz	2018/11/21 13:18	W => O	Stoptrain / Flirt	2210	---	-100	310	1.25	1	P-2, Y-axis

Measurement graphic (Y-axis):

Subrange	Step Size	Detectors	Bandwidth	Sweep Time	Preamp
9 kHz - 150 kHz	14.1 Hz	PK+	200 Hz	Coupled	0 dB
150 kHz - 30 MHz	2.985 kHz	PK+	9 kHz	Coupled	20 dB

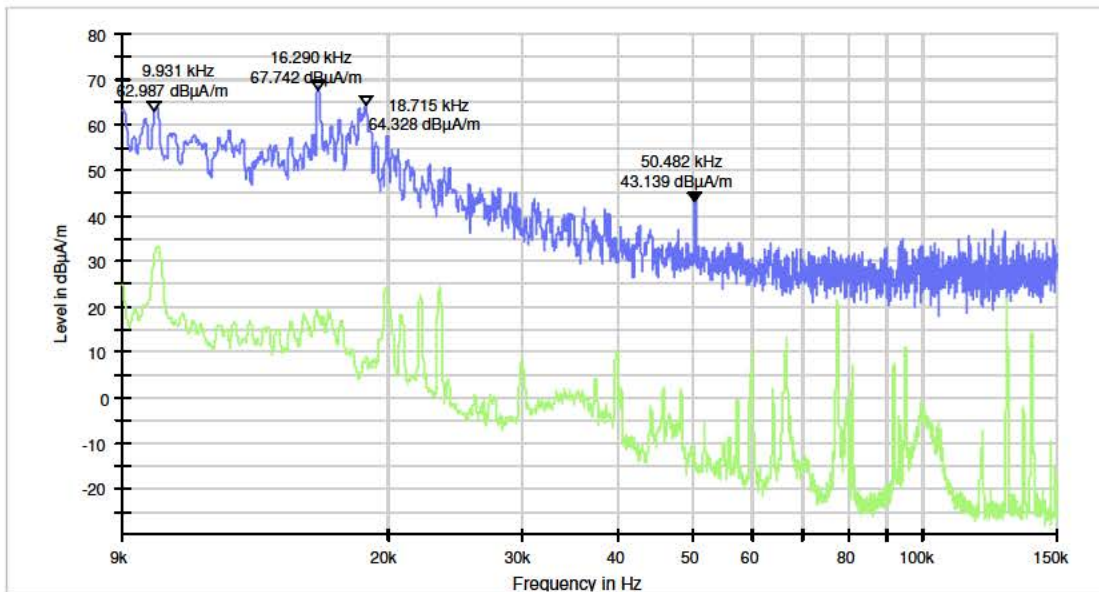

— PK+_MAXH — PK+_MAXH(1)@Ambient 9k - 150k

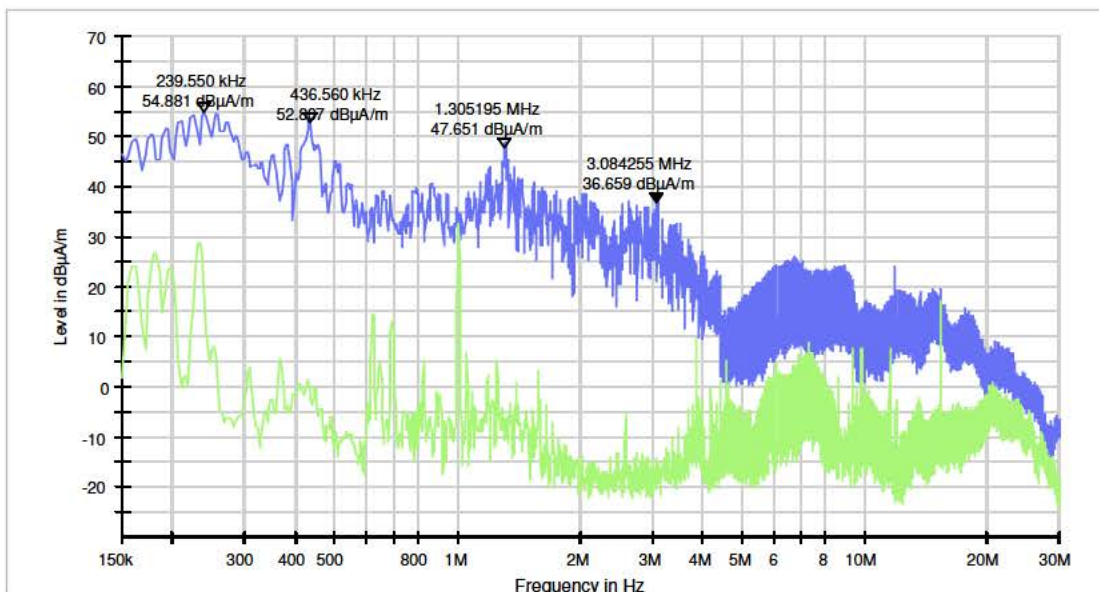

— PK+_MAXH — PK+_MAXH(1)@Ambient 150k - 30M

Frequency range	Date & Time	Direction	Operating condition / Train type	Train serial #		Estimated current during test [A]		Distance to track [m]	Height - sensor [m]	Remark
				1	2	Min	Max			
9 KHz-150 KHz	2018/11/21 15:04	W => O	Transit (IC) / DDZ	7608	---	-222	75	1.25	1	P-2, Y-axis
150 KHz-30 MHz	2018/11/21 13:04	W => O	Transit (IC) / DDZ	7616	---	-250	15	1.25	1	P-2, Y-axis

Measurement graphic (Y-axis):

Subrange 9 kHz - 150 kHz 150 kHz - 30 MHz	Step Size 14.1 Hz 2.985 kHz	Detectors PK+ PK+	Bandwidth 200 Hz 9 kHz	Sweep Time Coupled Coupled	Preamp 0 dB 20 dB
--	--	--------------------------------	-------------------------------------	---	--------------------------------

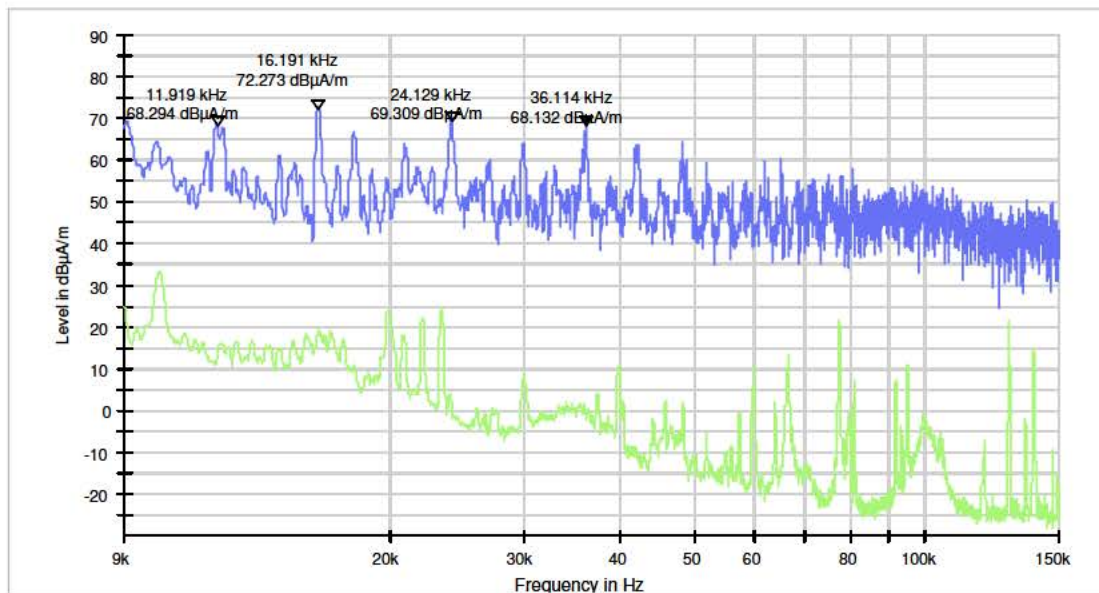

— PK+_MAXH — PK+_MAXH(1)@Ambient 9k - 150k

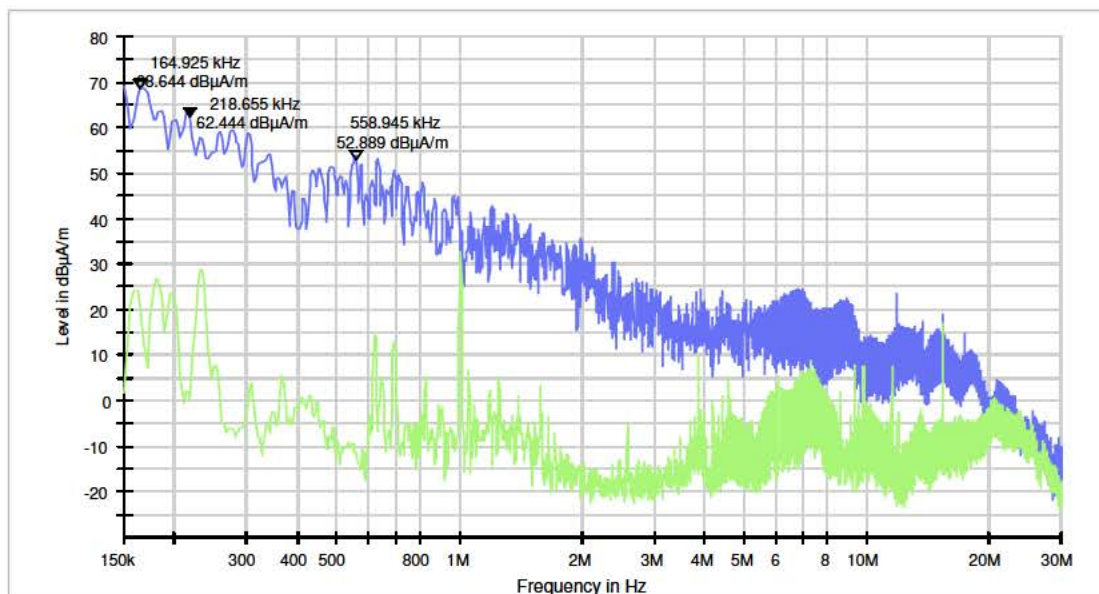

— PK+_MAXH — PK+_MAXH(1)@Ambient 150k - 30M

Frequency range	Date & Time	Direction	Operating condition / Train type	Train serial #		Estimated current during test [A]		Distance to track [m]	Height - sensor [m]	Remark
				1	2	Min	Max			
9 KHz-150 KHz	2018/11/21 15:48	W => O	Stoptrain / Flirt	2506	2208	-520	1265	1.25	1	P-2, Z-axis
150 KHz-30 MHz	2018/11/21 16:49	W => O	Stoptrain / Flirt	2224	2507	-678	789	1.25	1	P-2, Z-axis

Measurement graphic (Z-axis):

Subrange	Step Size	Detectors	Bandwidth	Sweep Time	Preamp
9 kHz - 150 kHz	14.1 Hz	PK+	200 Hz	Coupled	0 dB
150 kHz - 30 MHz	2.985 kHz	PK+	9 kHz	Coupled	20 dB

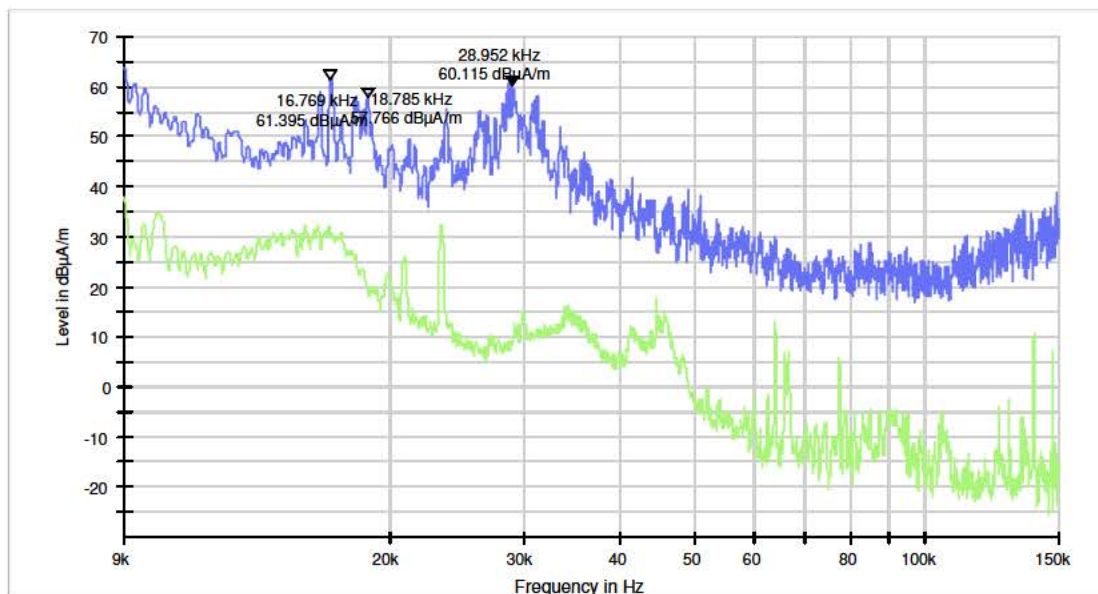

PK+_MAXH PK+_MAXH(1)@Ambient 9k-150K

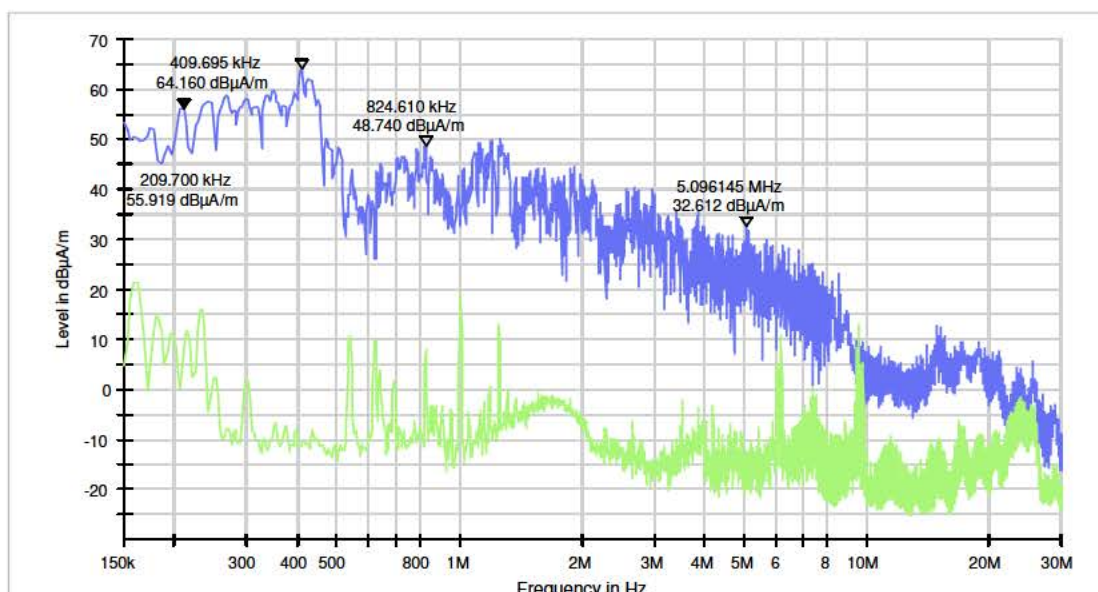

PK+_MAXH PK+_MAXH(1)@Ambient 150k-30M

Frequency range	Date & Time	Direction	Operating condition / Train type	Train serial #		Estimated current during test [A]		Distance to track [m]	Height - sensor [m]	Remark
				1	2	Min	Max			
9 KHz-150 KHz	2018/11/21 16:34	W => O	Transit (IC) / DDZ	7635	---	-202	77	1.25	1	P-2, Z-axis
150 KHz-30 MHz	2018/11/21 17:34	W => O	Transit (IC) / DDZ	7649	---	-194	45	1.25	1	P-2, Z-axis

Measurement graphic (Z-axis):

Subrange	Step Size	Detectors	Bandwidth	Sweep Time	Preamp
9 kHz - 150 kHz	14.1 Hz	PK+	200 Hz	Coupled	0 dB
150 kHz - 30 MHz	2.985 kHz	PK+	9 kHz	Coupled	20 dB

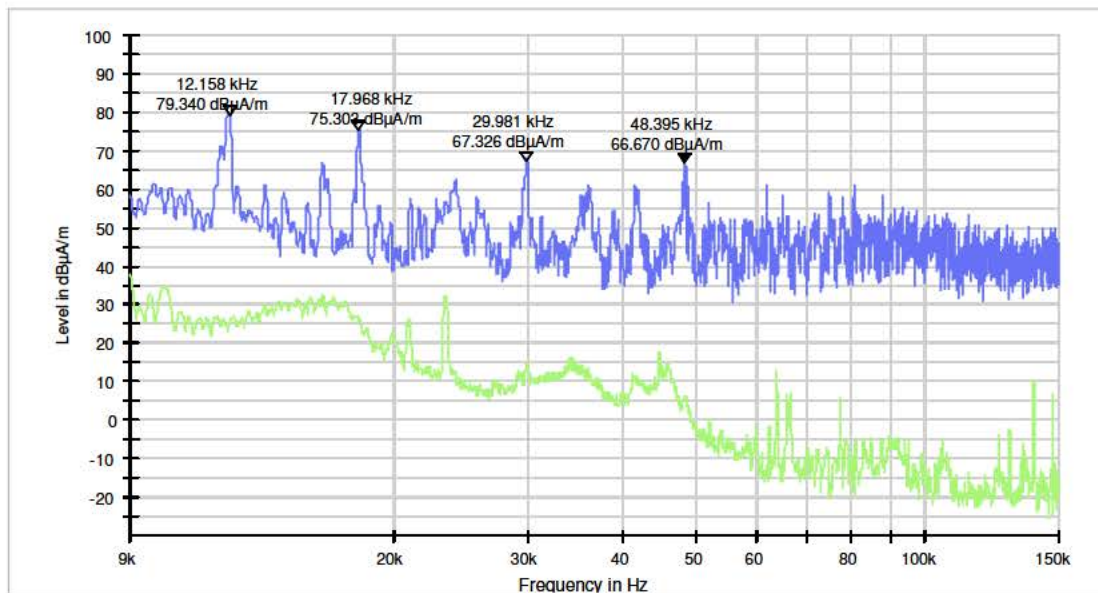

PK+_MAXH PK+_MAXH(1)@Ambient 9k-150K

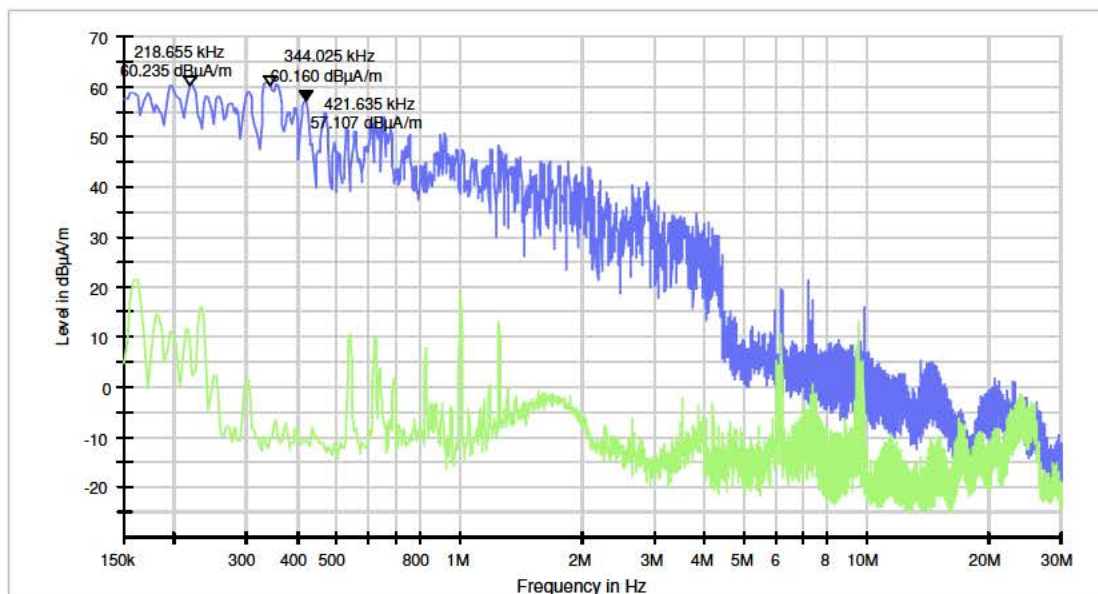

PK+_MAXH PK+_MAXH(1)@Ambient 150k-30M

A2.12 Stoptrain (acceleration)/ Transit / Braking, Barrier, h=1 m., d=3 m. (9 KHz - 30 MHz)

Frequency range	Date & Time	Direction	Operating condition / Train type	Train serial #		Estimated current during test [A]		Distance to track [m]	Height - sensor [m]	Remark
				1	2	Min	Max			
9 KHz-150 KHz	2018/11/23 09:17	W => O	Stoptrain / Flirt	2221	2224	-350	1200	3	1	P-3, X-axis
150 KHz-30 MHz	2018/11/23 11:40	W => O	Stoptrain / Flirt	2204	2219	-700	1200	3	1	P-3, X-axis ¹⁾

¹⁾ Acceleration train on track SP1ADC and braking train on track SP2ADC.

Measurement graphic (X-axis):

Subrange	Step Size	Detectors	Bandwidth	Sweep Time	Preamp
9 kHz - 150 kHz	14.1 Hz	PK+	200 Hz	Coupled	0 dB
150 kHz - 30 MHz	2.985 kHz	PK+	9 kHz	Coupled	20 dB

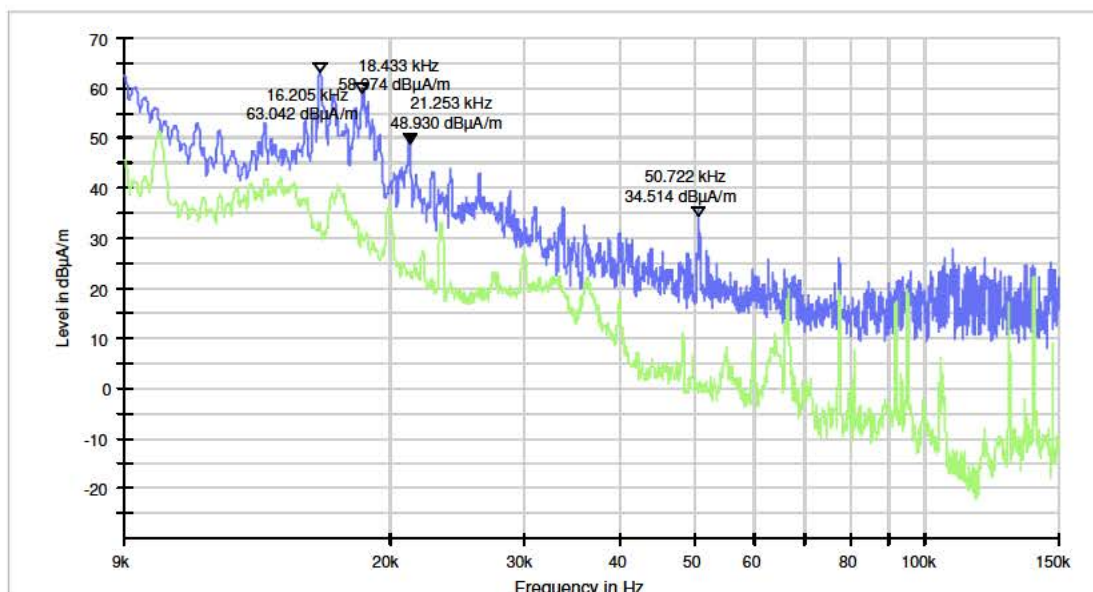

PK+_MAXH PK+_MAXH(1)@Ambient 9k - 150k

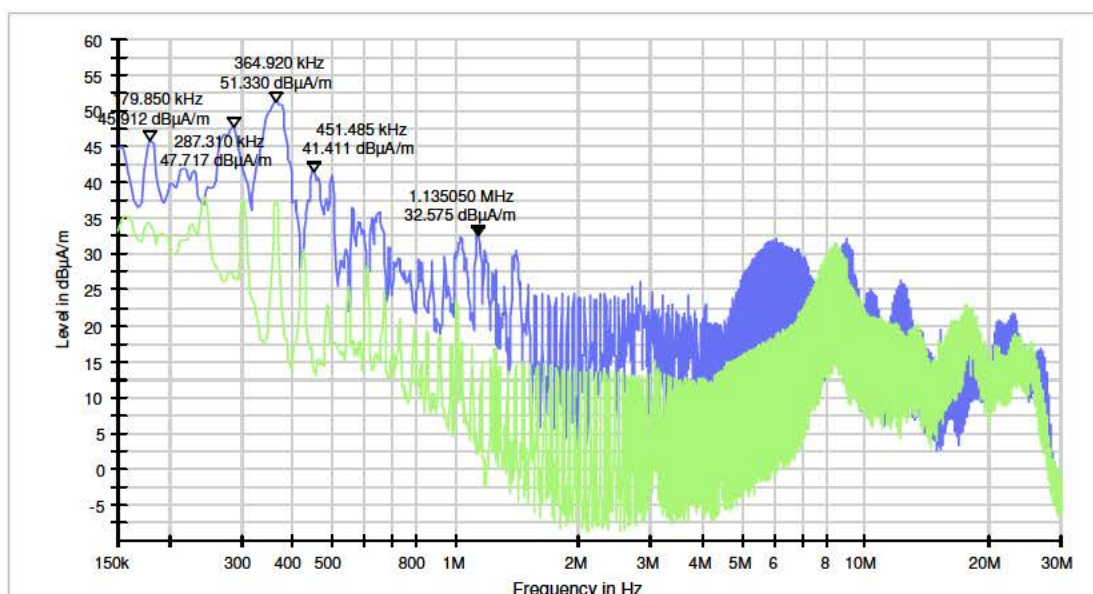

PK+_MAXH PK+_MAXH(1)@Ambient 150K30M

Frequency range	Date & Time	Direction	Operating condition / Train type	Train serial #		Estimated current during test [A]		Distance to track [m]	Height - sensor [m]	Remark
				1	2	Min	Max			
9 KHz-150 KHz	2018/11/23 09:05	W => O	Transit (IC) / DDZ	7521	7646	-300	0	3	1	P-3, X-axis
150 KHz-30 MHz	2018/11/23 09:35	W => O	Transit (IC) / DDZ	7632	---	-250	40	3	1	P-3, X-axis

Measurement graphic (X-axis):

Subrange	Step Size	Detectors	Bandwidth	Sweep Time	Preamp
9 kHz - 150 kHz	14.1 Hz	PK+	200 Hz	Coupled	0 dB
150 kHz - 30 MHz	2.985 kHz	PK+	9 kHz	Coupled	20 dB

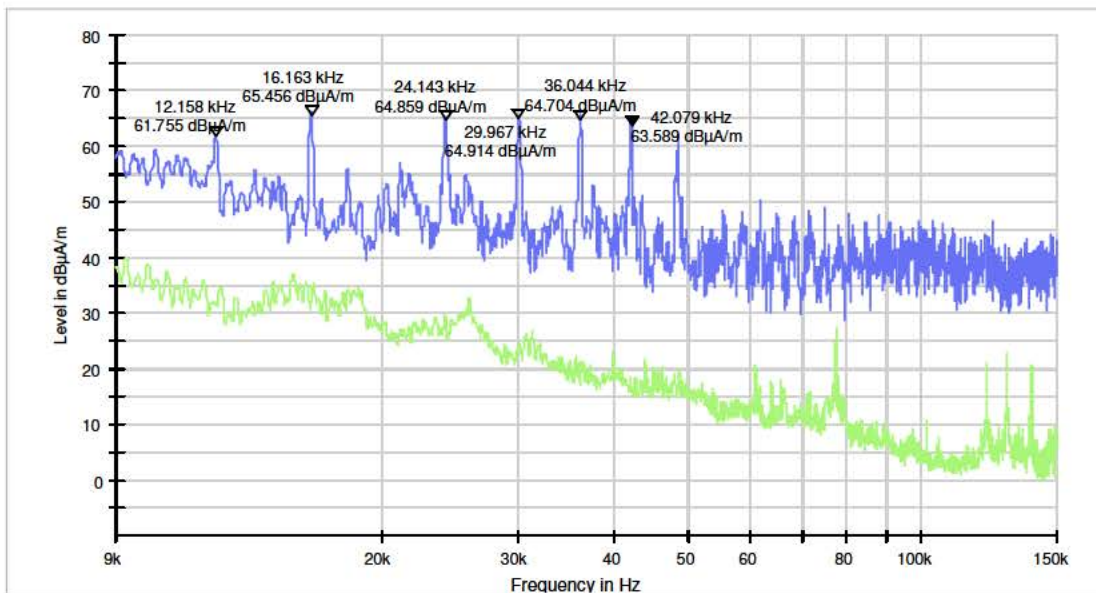

PK+_MAXH PK+_MAXH(1)@Ambient 9K150K

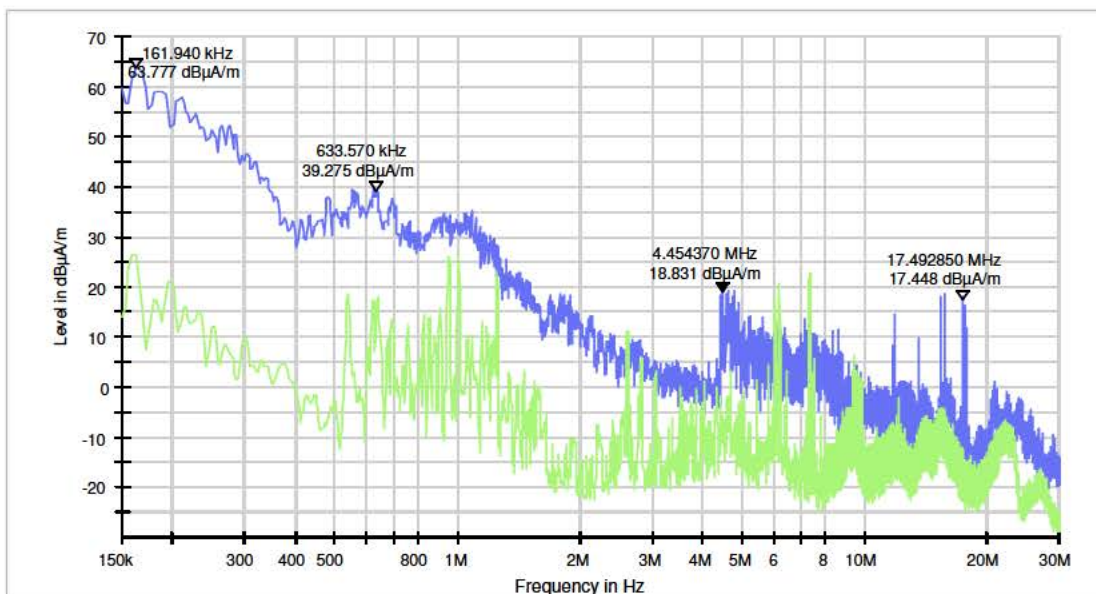

PK+_MAXH PK+_MAXH(1)@Ambient

Frequency range	Date & Time	Direction	Operating condition / Train type	Train serial #		Estimated current during test [A]		Distance to track [m]	Height - sensor [m]	Remark
				1	2	Min	Max			
9 KHz-150 KHz	2018/11/23 08:52	W => O	Stoptrain / Flirt	2209	2518	-200	850	3	1	P-3, Y-axis
150 KHz-30 MHz	2018/11/23 10:27	W => O	Stoptrain / Flirt	2211	2228	-448	1529	3	1	P-3, Y-axis

Measurement graphic (Y-axis):

Subrange	Step Size	Detectors	Bandwidth	Sweep Time	Preamp
9 kHz - 150 kHz	14.1 Hz	PK+	200 Hz	Coupled	0 dB
150 kHz - 30 MHz	2.985 kHz	PK+	9 kHz	Coupled	20 dB

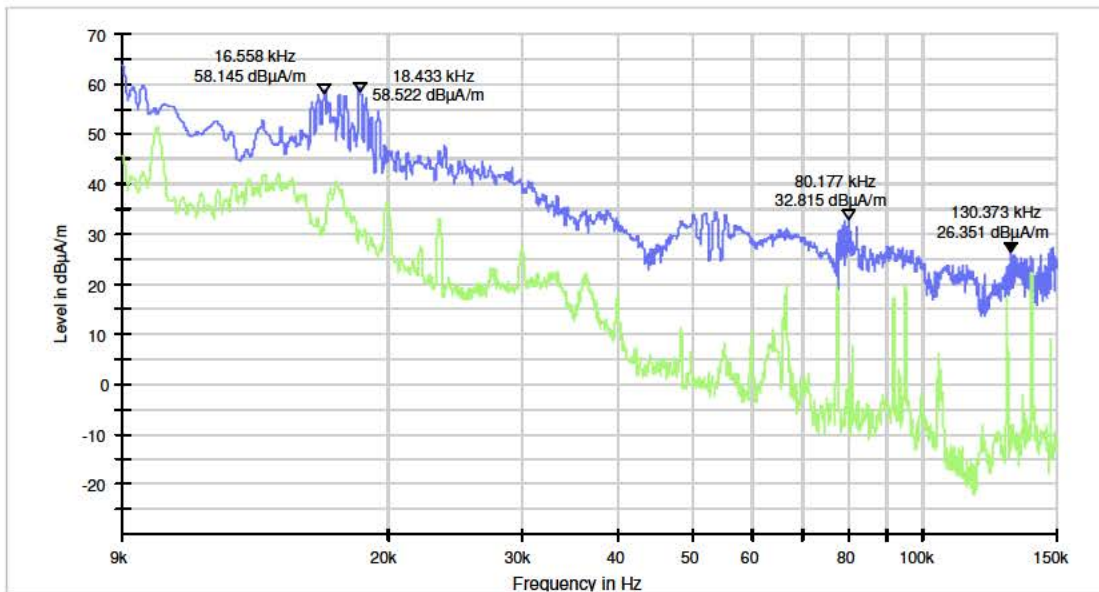

— PK+_MAXH — PK+_MAXH(1)@Ambient 9k - 150k

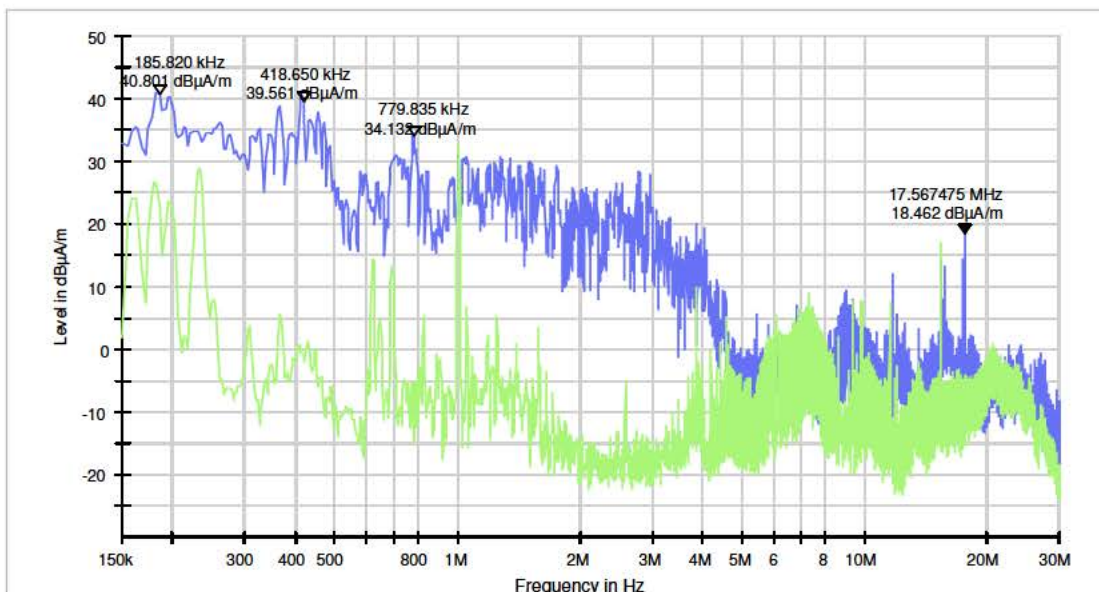

— PK+_MAXH — PK+_MAXH(1)@Ambient 150k - 30M

Frequency range	Date & Time	Direction	Operating condition / Train type	Train serial #		Estimated current during test [A]		Distance to track [m]	Height - sensor [m]	Remark
				1	2	Min	Max			
9 KHz-150 KHz	2018/11/23 10:42	W => O	Transit (IC) / DDZ	---	---	---	---	3	1	P-3, Y-axis
150 KHz-30 MHz	2018/11/23 10:03	W => O	Transit (IC) / DDZ	7511	---	-150	150	3	1	P-3, Y-axis

Measurement graphic (Y-axis):

Subrange	Step Size	Detectors	Bandwidth	Sweep Time	Preamp
9 kHz - 150 kHz	14.1 Hz	PK+	200 Hz	Coupled	0 dB
150 kHz - 30 MHz	2.985 kHz	PK+	9 kHz	Coupled	20 dB

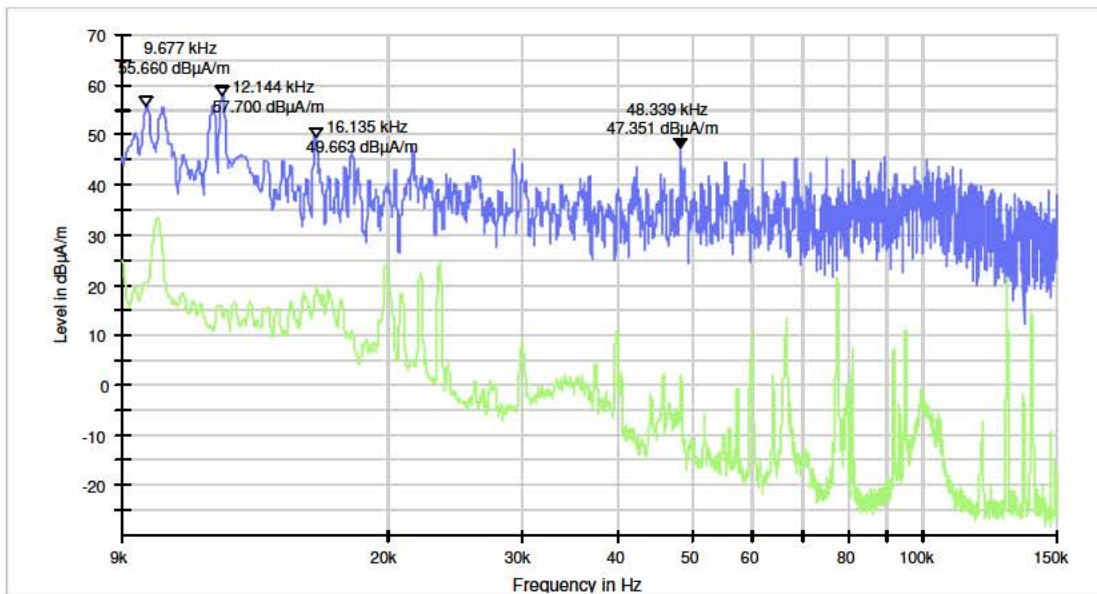

PK+_MAXH PK+_MAXH(1)@Ambient 9k - 150k

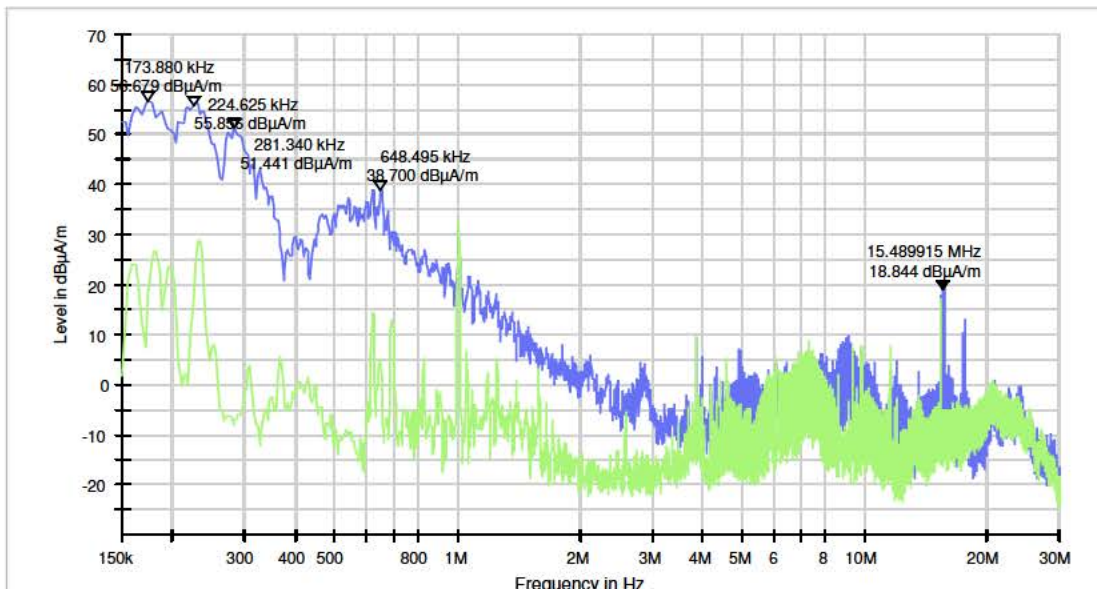

PK+_MAXH PK+_MAXH(1)@Ambient 150k - 30M

Frequency range	Date & Time	Direction	Operating condition / Train type	Train serial #		Estimated current during test [A]		Distance to track [m]	Height - sensor [m]	Remark
				1	2	Min	Max			
9 KHz-150 KHz	2018/11/23 10:46	O => W	Braking at track 2	---	---	---	---	3	1	P-3, Y-axis

Measurement graphic (Y-axis):

Subrange: 9 kHz - 150 kHz Step Size: 14.1 Hz Detectors: PK+ Bandwidth: 200 Hz Sweep Time: Coupled Preamp: 0 dB

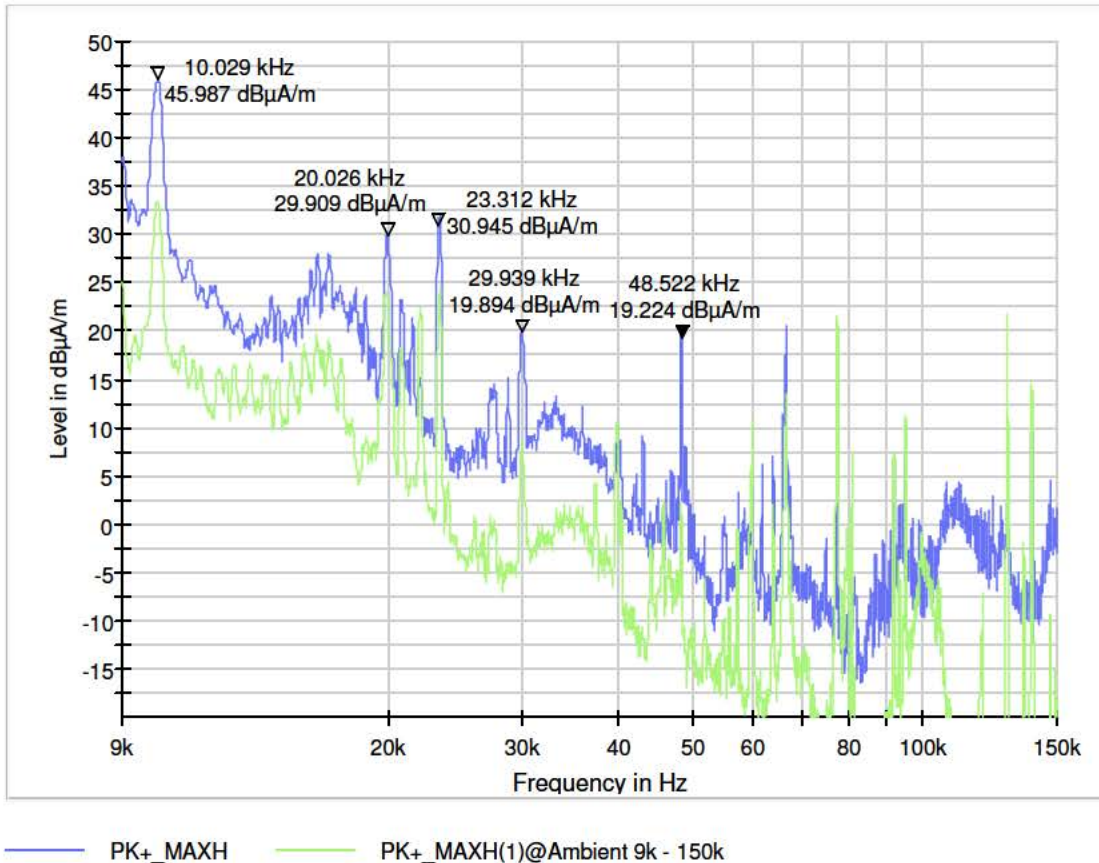

Frequency range	Date & Time	Direction	Operating condition / Train type	Train serial #		Estimated current during test [A]		Distance to track [m]	Height - sensor [m]	Remark
				1	2	Min	Max			
9 KHz-150 KHz	2018/11/23 10:53	W => O	Stoptrain / Flirt	2508	2229	-450	1050	3	1	P-3, Z-axis
150 KHz-30 MHz	2018/11/23 11:17	W => O	Stoptrain / Flirt	2213	2515	-920	600	3	1	P-3, Z-axis

Measurement graphic (Z-axis):

Subrange	Step Size	Detectors	Bandwidth	Sweep Time	Preamp
9 kHz - 150 kHz	14.1 Hz	PK+	200 Hz	Coupled	0 dB
150 kHz - 30 MHz	2.985 kHz	PK+	9 kHz	Coupled	20 dB

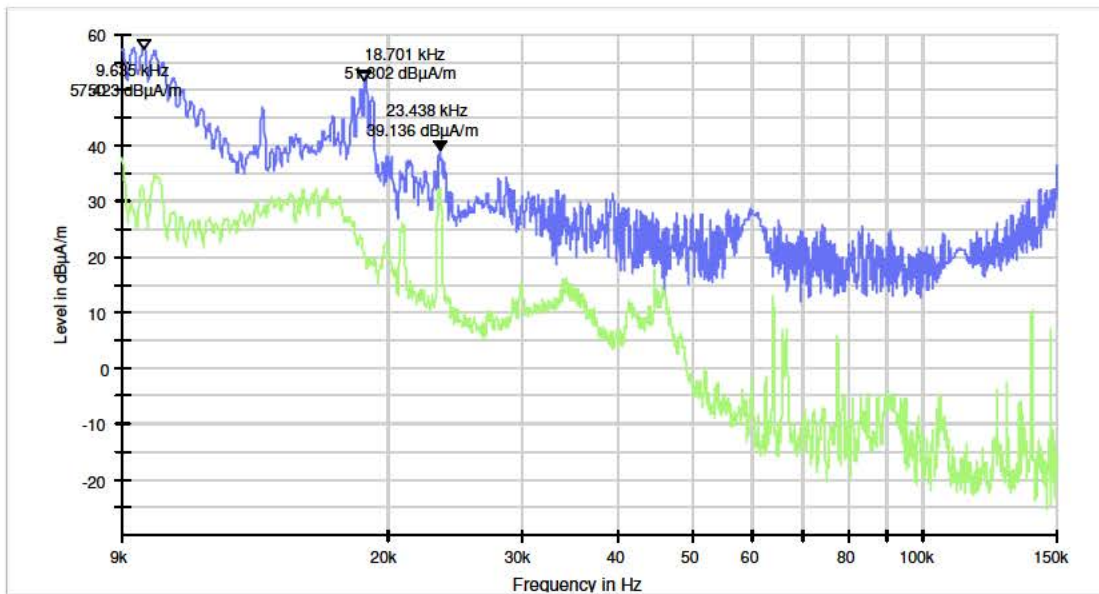

— PK+_MAXH — PK+_MAXH(1)@Ambient 9k-150K

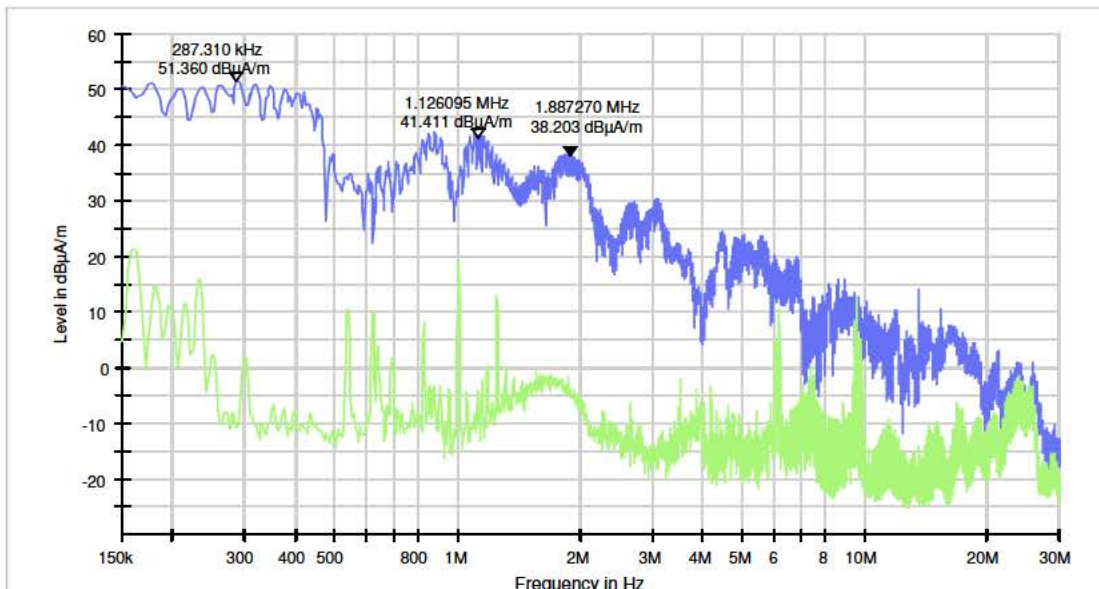

— PK+_MAXH — PK+_MAXH(1)@Ambient 150k-30M

Frequency range	Date & Time	Direction	Operating condition / Train type	Train serial #		Estimated current during test [A]		Distance to track [m]	Height - sensor [m]	Remark
				1	2	Min	Max			
9 KHz-150 KHz	2018/11/21 19:04	W => O	Transit (IC) / DDZ	7533	---	-236	95	3	1	P-3, Z-axis
150 KHz-30 MHz	2018/11/23 11:04	W => O	Transit (IC) / DDZ	7623	---	-125	110	3	1	P-3, Z-axis

Measurement graphic (Z-axis):

Subrange 9 kHz - 150 kHz 150 kHz - 30 MHz	Step Size 14.1 Hz 2.985 kHz	Detectors PK+ PK+	Bandwidth 200 Hz 9 kHz	Sweep Time Coupled Coupled	Preamp 0 dB 20 dB
--	--	--------------------------------	-------------------------------------	---	--------------------------------

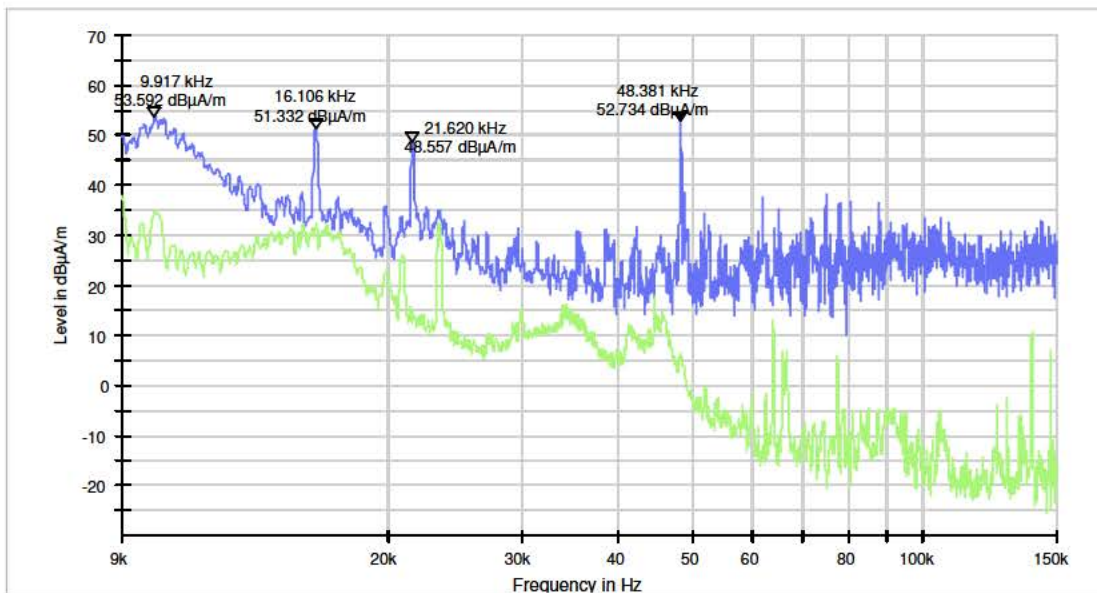

PK+_MAXH PK+_MAXH(1)@Ambient 9k-150K

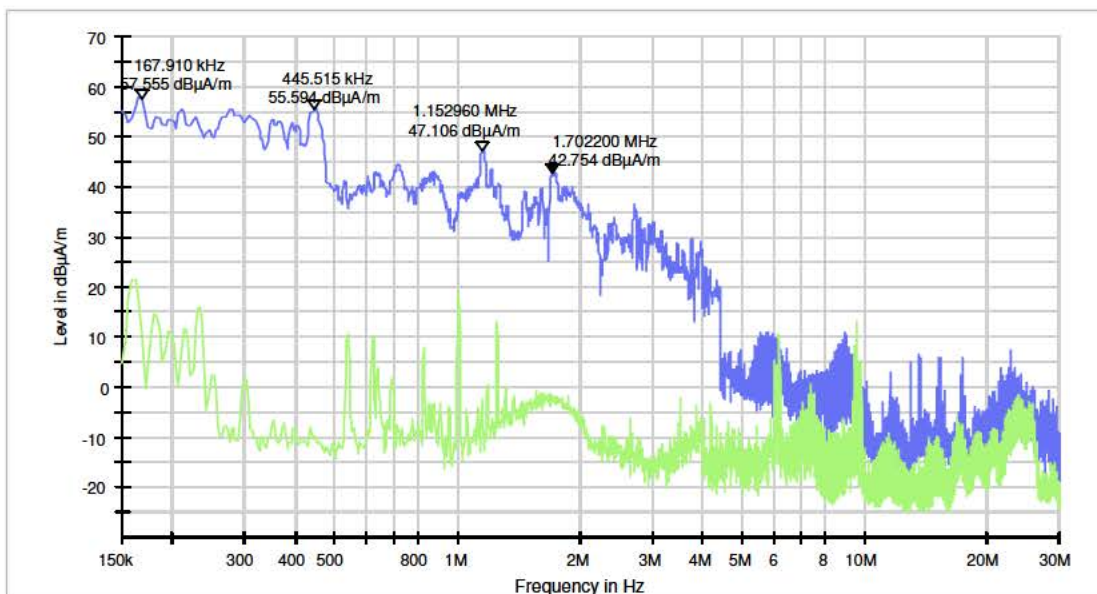

PK+_MAXH PK+_MAXH(1)@Ambient 150k-30M

A2.13 Stoptrain (acceleration)/ Transit / Braking, Barrier, h=1 m., d=10 m. (9 KHz - 30 MHz)

Frequency range	Date & Time	Direction	Operating condition / Train type	Train serial #		Estimated current during test [A]		Distance to track [m]	Height - sensor [m]	Remark
				1	2	Min	Max			
9 KHz-150 KHz	2018/11/23 14:47	W => O	Stoptrain / Flirt	2210	250x	-750	900	10	1	P-5, X-axis
150 KHz-30 MHz	2018/11/21 10:49	W => O	Stoptrain / Flirt	2515	2213	-550	870	10	1	P-5, X-axis ¹⁾

Measurement graphic (X-axis):

Subrange	Step Size	Detectors	Bandwidth	Sweep Time	Preamp
9 kHz - 150 kHz	14.1 Hz	PK+	200 Hz	Coupled	0 dB
150 kHz - 30 MHz	2.985 kHz	PK+	9 kHz	Coupled	20 dB

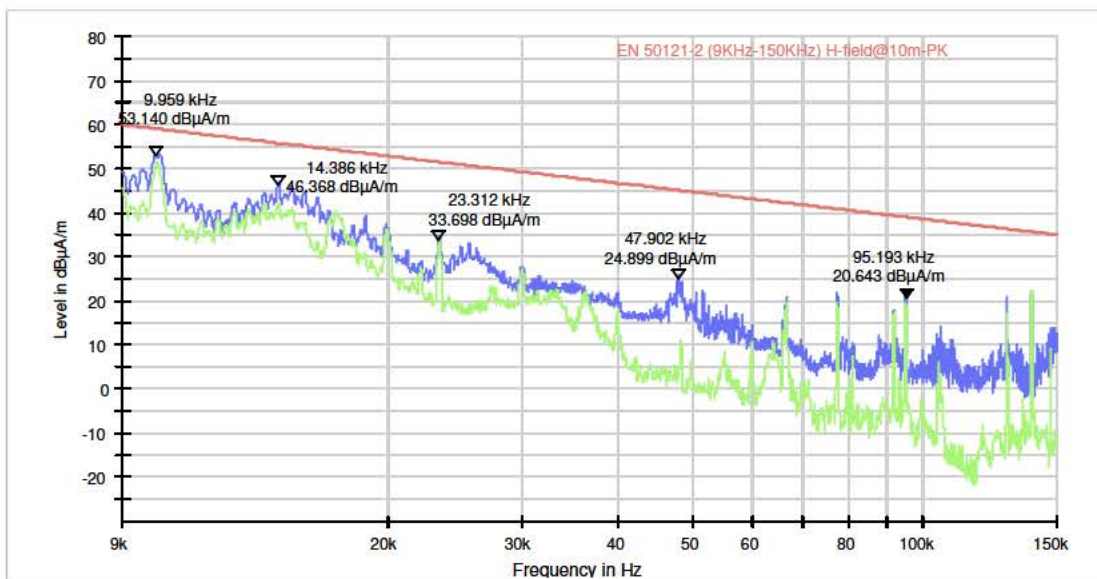

— PK+ MAXH
 — EN 50121-2 (9KHz-150KHz) H-field@10m-PK
 — PK+ MAXH(1)@Ambient 9k - 150k

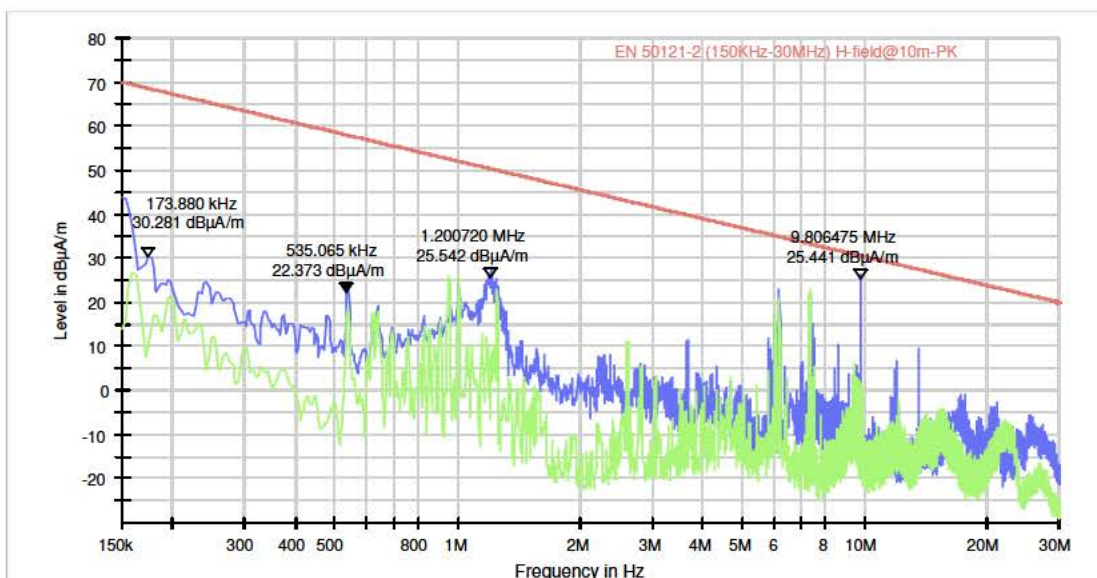

— PK+ MAXH
 — EN 50121-2 (150KHz-30MHz) H-field@10m-PK
 — PK+ MAXH(1)@Ambient 150K-30M

Frequency range	Date & Time	Direction	Operating condition / Train type	Train serial #		Estimated current during test [A]		Distance to track [m]	Height - sensor [m]	Remark
				1	2	Min	Max			
9 KHz-150 KHz	2018/11/23 14:34	W => O	Transit (IC) / DDZ	7608	---	-200	200	10	1	P-5, X-axis
150 KHz-30 MHz	2018/11/26 17:48	W => O	Transit (IC) / DDZ	---	---	---	---	10	1	P-5, X-axis

Measurement graphic (X-axis):

Subrange	Step Size	Detectors	Bandwidth	Sweep Time	Preamp
9 kHz - 150 kHz	14.1 Hz	PK+	200 Hz	Coupled	0 dB
150 kHz - 30 MHz	2.985 kHz	PK+	9 kHz	Coupled	20 dB

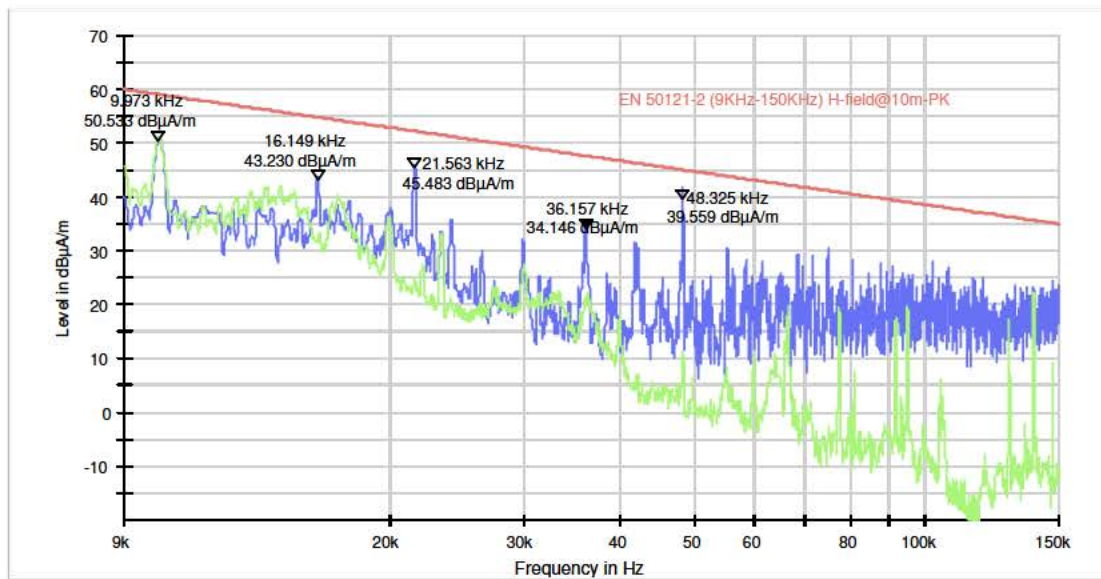

— PK+_MAXH
— EN 50121-2 (9KHz-150KHz) H-field@10m-PK
— PK+_MAXH(1)@Ambient 9k - 150k

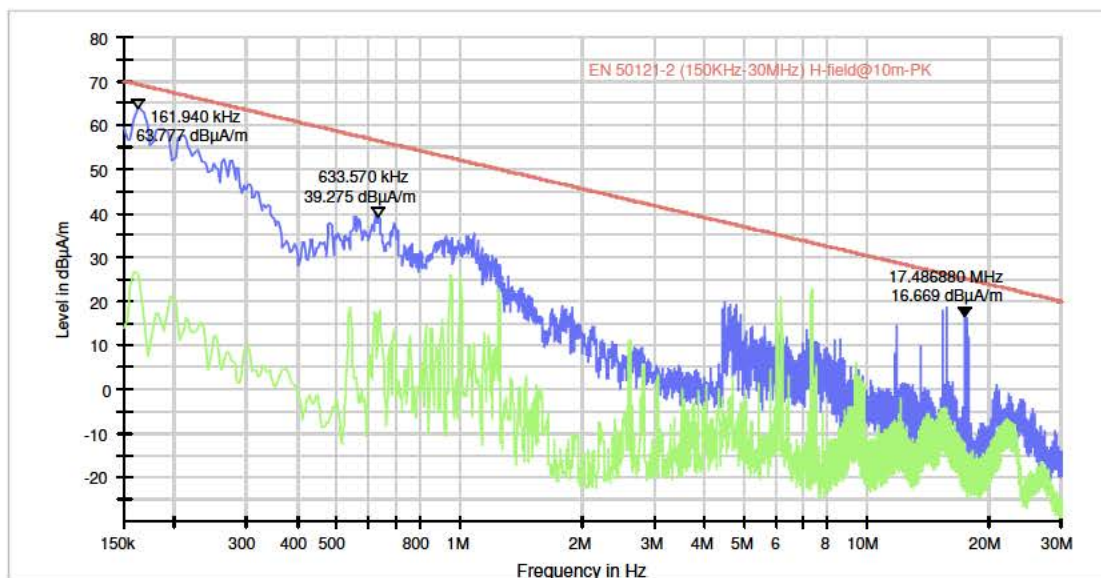

— PK+_MAXH
— EN 50121-2 (150KHz-30MHz) H-field@10m-PK
— PK+_MAXH(1)@Ambient 150K30M

Frequency range	Date & Time	Direction	Operating condition / Train type	Train serial #		Estimated current during test [A]		Distance to track [m]	Height - sensor [m]	Remark
				1	2	Min	Max			
9 KHz-150 KHz	2018/11/23 15:18	W => O	Stoptrain / Flirt	2211	2228	-650	1200	10	1	P-5, Y-axis
150 KHz-30 MHz	2018/11/23 16:27	W => O	Stoptrain / Flirt	2512	---	-296	196	10	1	P-5, Y-axis ¹⁾

¹⁾ Stoptrain (acceleration) on track SP1ADC and IC DDZ train on track SP2ADC.

Measurement graphic (Y-axis):

Subrange	Step Size	Detectors	Bandwidth	Sweep Time	Preamp
9 kHz - 150 kHz	14.1 Hz	PK+	200 Hz	Coupled	0 dB
150 kHz - 30 MHz	2.985 kHz	PK+	9 kHz	Coupled	20 dB

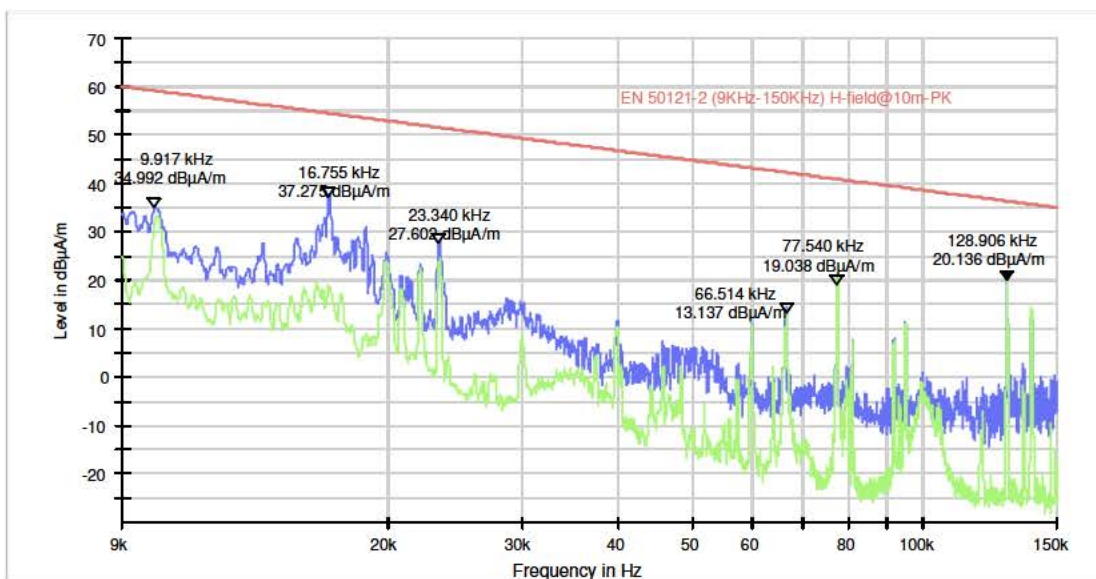

— PK+_MAXH
— EN 50121-2 (9KHz-150KHz) H-field@10m-PK
— PK+_MAXH(1)@Ambient 9k - 150k

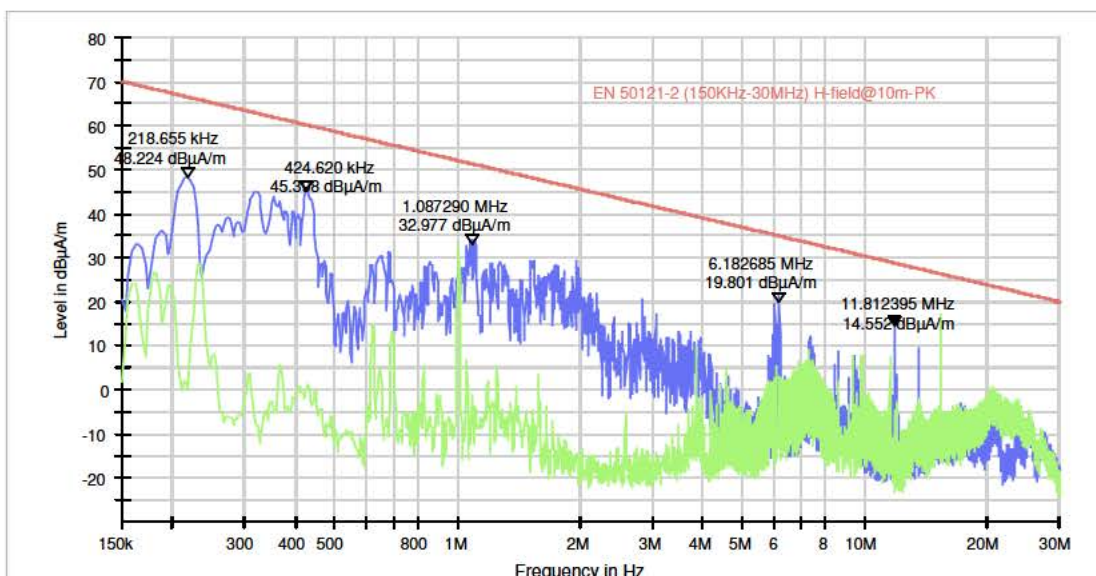

— PK+_MAXH
— EN 50121-2 (150KHz-30MHz) H-field@10m-PK
— PK+_MAXH(1)@Ambient 150k - 30M

Frequency range	Date & Time	Direction	Operating condition / Train type	Train serial #		Estimated current during test [A]		Distance to track [m]	Height - sensor [m]	Remark
				1	2	Min	Max			
9 KHz-150 KHz	2018/11/23 15:05	W => O	Transit (IC) / DDZ	7512	7646	-225	100	10	1	P-5, Y-axis
150 KHz-30 MHz	2018/11/23 16:03	W => O	Transit (IC) / DDZ	7511	---	-380	-175	10	1	P-5, Y-axis

Measurement graphic (Y-axis):

Subrange	Step Size	Detectors	Bandwidth	Sweep Time	Preamp
9 kHz - 150 kHz	14.1 Hz	PK+	200 Hz	Coupled	0 dB
150 kHz - 30 MHz	2.985 kHz	PK+	9 kHz	Coupled	20 dB

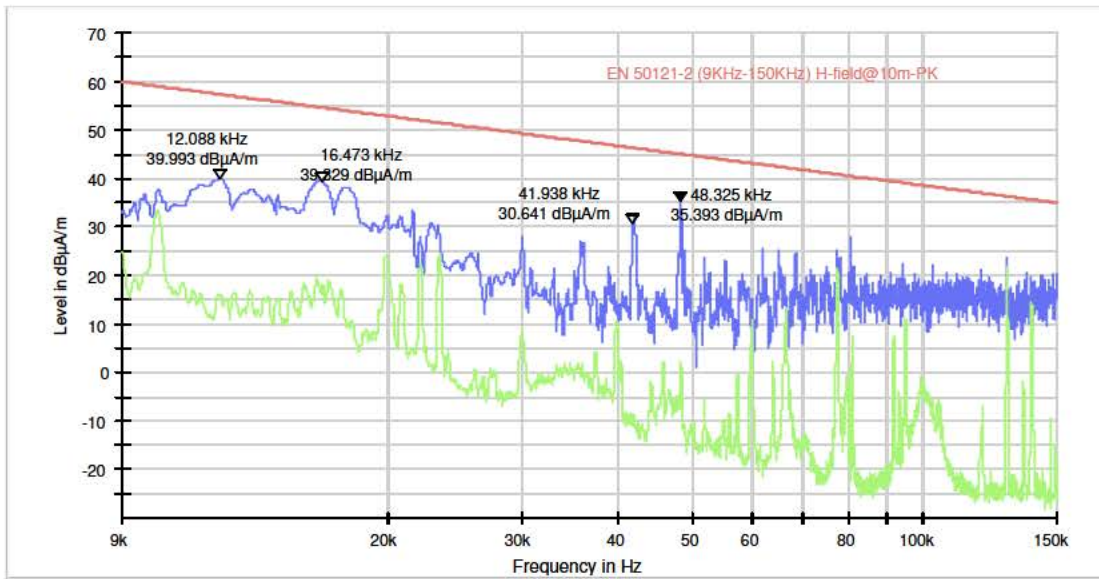

— PK+_MAXH
 — EN 50121-2 (9kHz-150kHz) H-field@10m-PK
 — PK+_MAXH(1)@Ambient 9k - 150k

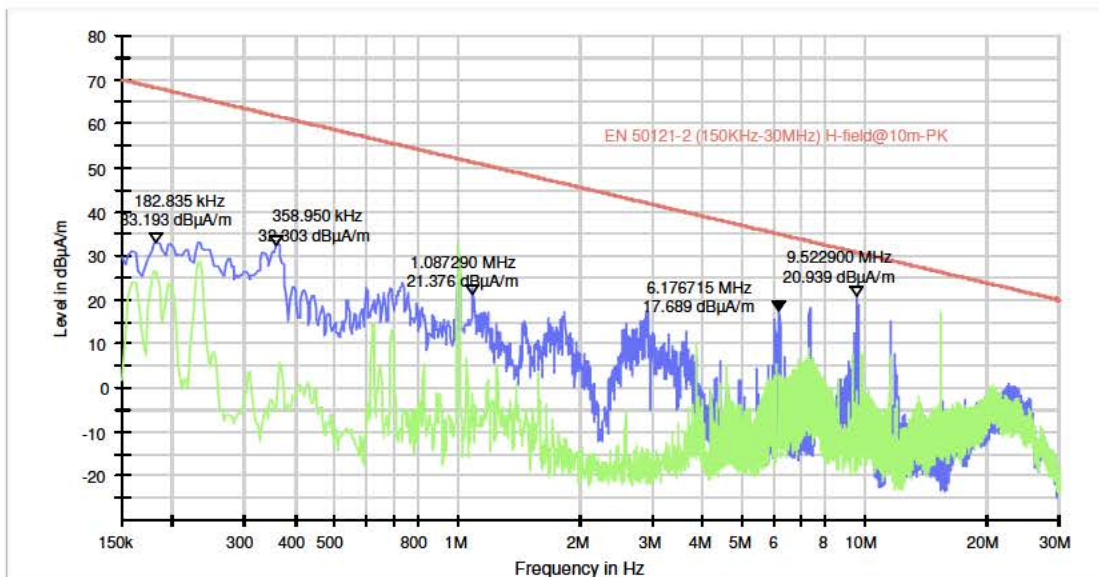

— PK+_MAXH
 — EN 50121-2 (150kHz-30MHz) H-field@10m-PK
 — PK+_MAXH(1)@Ambient 150k - 30M

Frequency range	Date & Time	Direction	Operating condition / Train type	Train serial #		Estimated current during test [A]		Distance to track [m]	Height - sensor [m]	Remark
				1	2	Min	Max			
9 KHz-150 KHz	2018/11/23 16:57	W => O	Stoptrain / Flirt	2514	---	-350	70	10	1	P-5, Z-axis ¹⁾
150 KHz-30 MHz	2018/11/23 16:48	W => O	Stoptrain / Flirt	2219	2230	-350	900	10	1	P-5, Z-axis

¹⁾ Stoptrain (acceleration) on track SP1ADC and IC DDZ train on track SP2ADC.

Measurement graphic (Z-axis):

Subrange	Step Size	Detectors	Bandwidth	Sweep Time	Preamp
9 kHz - 150 kHz	14.1 Hz	PK+	200 Hz	Coupled	0 dB
150 kHz - 30 MHz	2.985 kHz	PK+	9 kHz	Coupled	20 dB

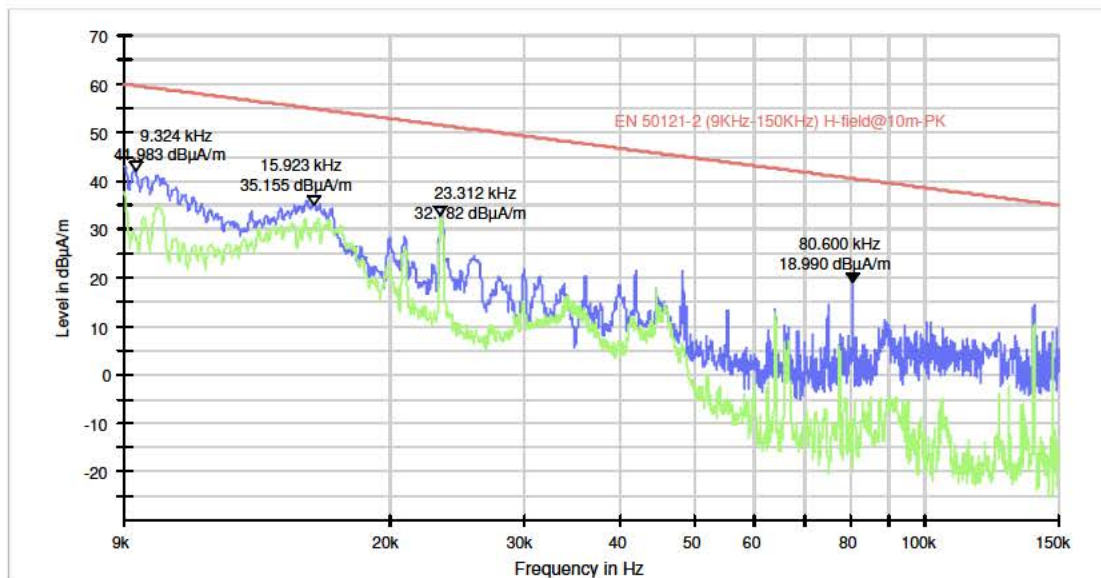

— PK+_MAXH
 — EN 50121-2 (9KHz-150KHz) H-field@10m-PK
 — PK+_MAXH(1)@Ambient 9k-150k

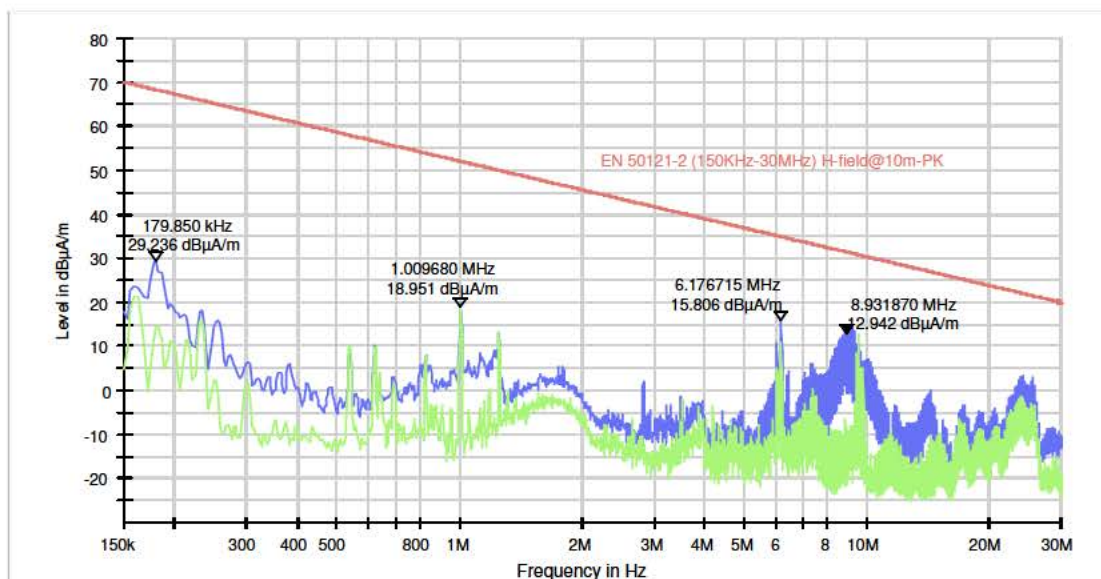

— PK+_MAXH
 — EN 50121-2 (150KHz-30MHz) H-field@10m-PK
 — PK+_MAXH(1)@Ambient 150k - 30M

Frequency range	Date & Time	Direction	Operating condition / Train type	Train serial #		Estimated current during test [A]		Distance to track [m]	Height - sensor [m]	Remark
				1	2	Min	Max			
9 KHz-150 KHz	2018/11/21 16:34	W => O	Transit (IC) / DDZ	7637	---	-170	200	10	1	P-5, Z-axis ¹⁾
150 KHz-30 MHz	2018/11/23 16:34	W => O	Transit (IC) / DDZ	7510	---	-700	20	10	1	P-5, Z-axis

¹⁾ Transit (intercity) train on track SP1ADC and freight train on track SP2ADC.

Measurement graphic (Z-axis):

Subrange	Step Size	Detectors	Bandwidth	Sweep Time	Preamp
9 kHz - 150 kHz	14.1 Hz	PK+	200 Hz	Coupled	0 dB
150 kHz - 30 MHz	2.985 kHz	PK+	9 kHz	Coupled	20 dB

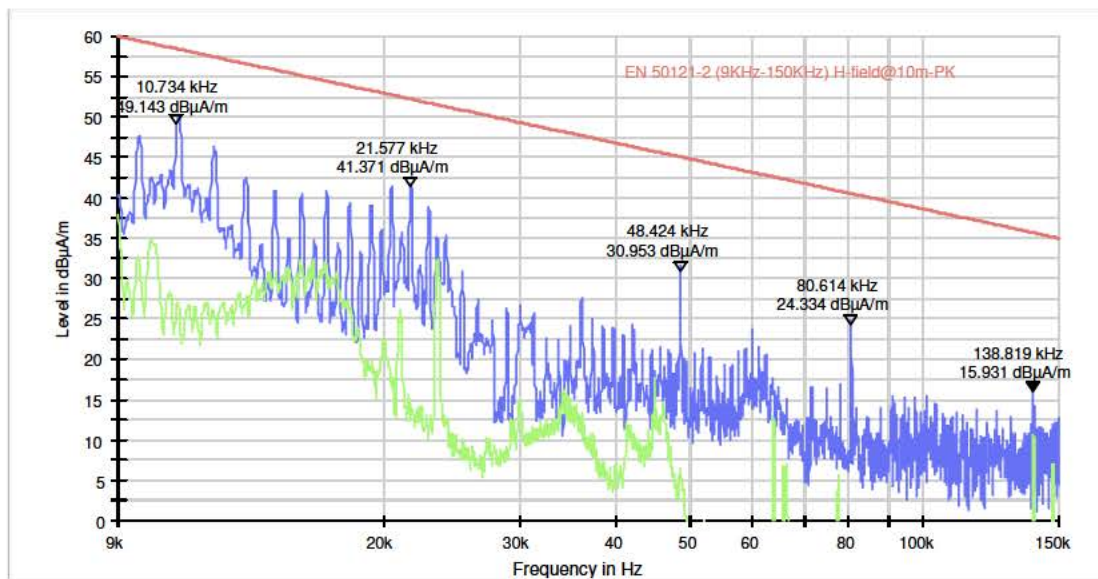

— PK+_MAXH
 — EN 50121-2 (9kHz-150kHz) H-field@10m-PK
 — PK+_MAXH(1)@Ambient 9k-150k

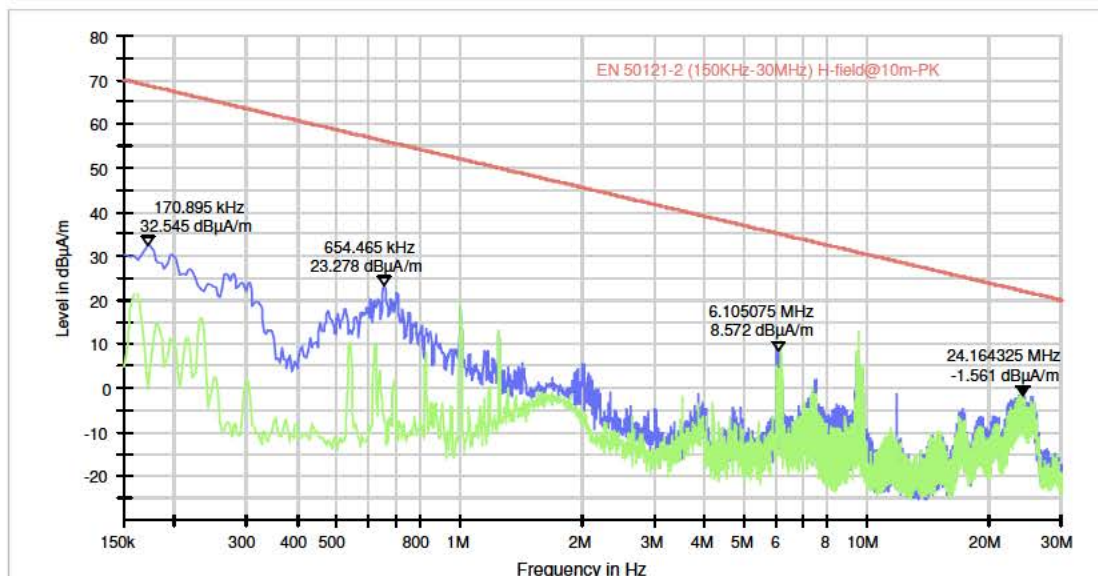

— PK+_MAXH
 — EN 50121-2 (150kHz-30MHz) H-field@10m-PK
 — PK+_MAXH(1)@Ambient 150k - 30M

A2.14 Stoptrain (acceleration)/ Transit / Braking, Barrier, h=1 m., d=30 m. (9 KHz - 30 MHz)

Frequency range	Date & Time	Direction	Operating condition / Train type	Train serial #		Estimated current during test [A]		Distance to track [m]	Height - sensor [m]	Remark
				1	2	Min	Max			
9 KHz-150 KHz	2018/11/26 16:17	W => O	Stoptrain / Flirt	2509	2212	-750	950	30	1	P-6, X-axis
150 KHz-30 MHz	2018/11/26 16:26	W => O	Stoptrain / Flirt	2220	2514	-800	-110	30	1	P-6, X-axis ¹⁾

¹⁾ Stoptrain (acceleration) on track SP1ADC and intercity DDZ (O => W) train on track SP2ADC.

Measurement graphic (X-axis):

Subrange	Step Size	Detectors	Bandwidth	Sweep Time	Preamp
9 kHz - 150 kHz	14.1 Hz	PK+	200 Hz	Coupled	0 dB
150 kHz - 30 MHz	2.985 kHz	PK+	9 kHz	Coupled	20 dB

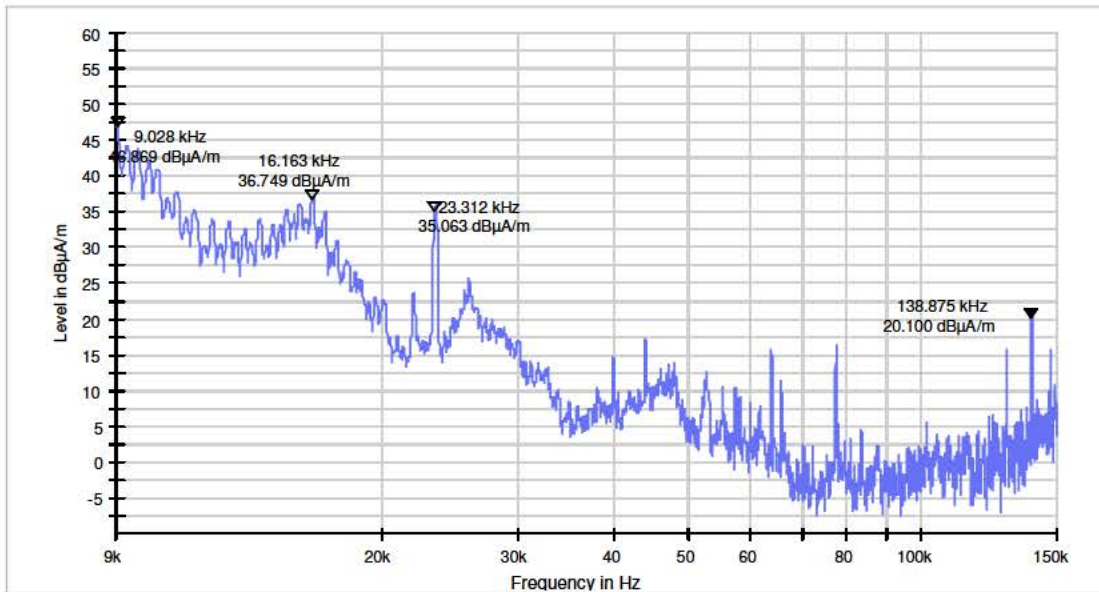

PK+_MAXH

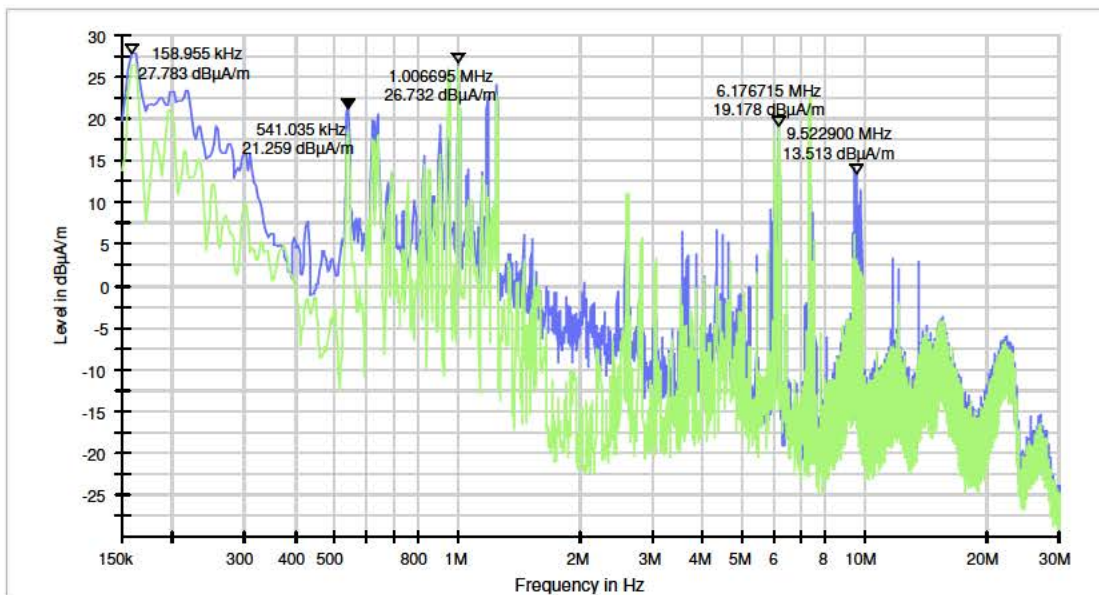

PK+_MAXH

PK+_MAXH(1)@Ambient 150K-30M

Frequency range	Date & Time	Direction	Operating condition / Train type	Train serial #		Estimated current during test [A]		Distance to track [m]	Height - sensor [m]	Remark
				1	2	Min	Max			
9 KHz-150 KHz	2018/11/26 15:51	W => O	Transit / Flirt	2xxx	2xxx	-460	450	30	1	P-6, X-axis
150 KHz-30 MHz	2018/11/26 16:34	W => O	Transit (IC) / DDZ	7608	---	-150	275	30	1	P-6, X-axis

Measurement graphic (X-axis):

Subrange	Step Size	Detectors	Bandwidth	Sweep Time	Preamp
9 kHz - 150 kHz	14.1 Hz	PK+	200 Hz	Coupled	0 dB
150 kHz - 30 MHz	2.985 kHz	PK+	9 kHz	Coupled	20 dB

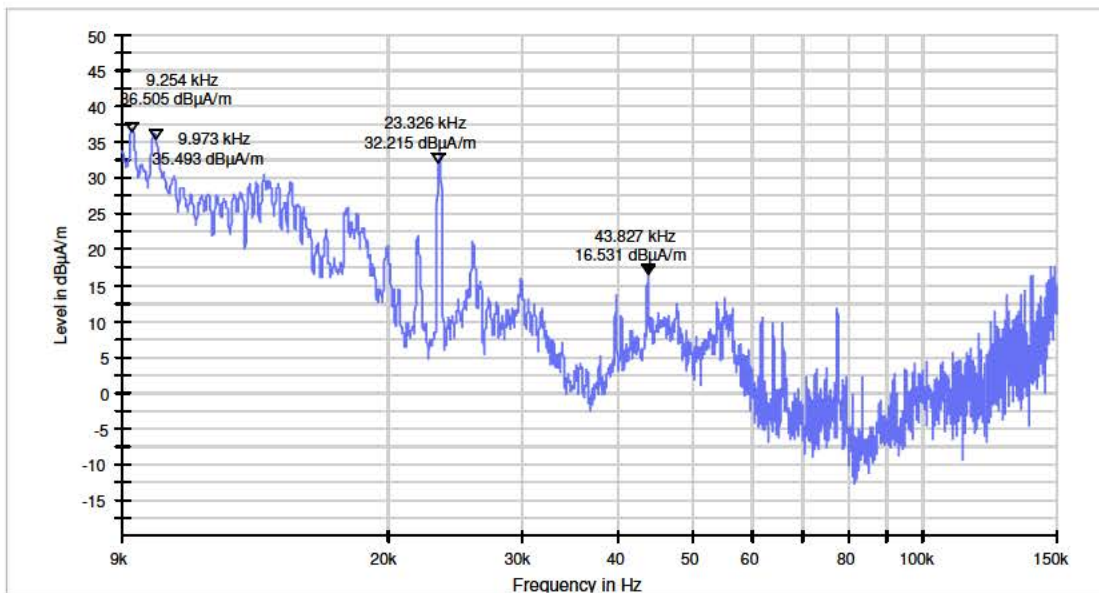

PK+_MAXH

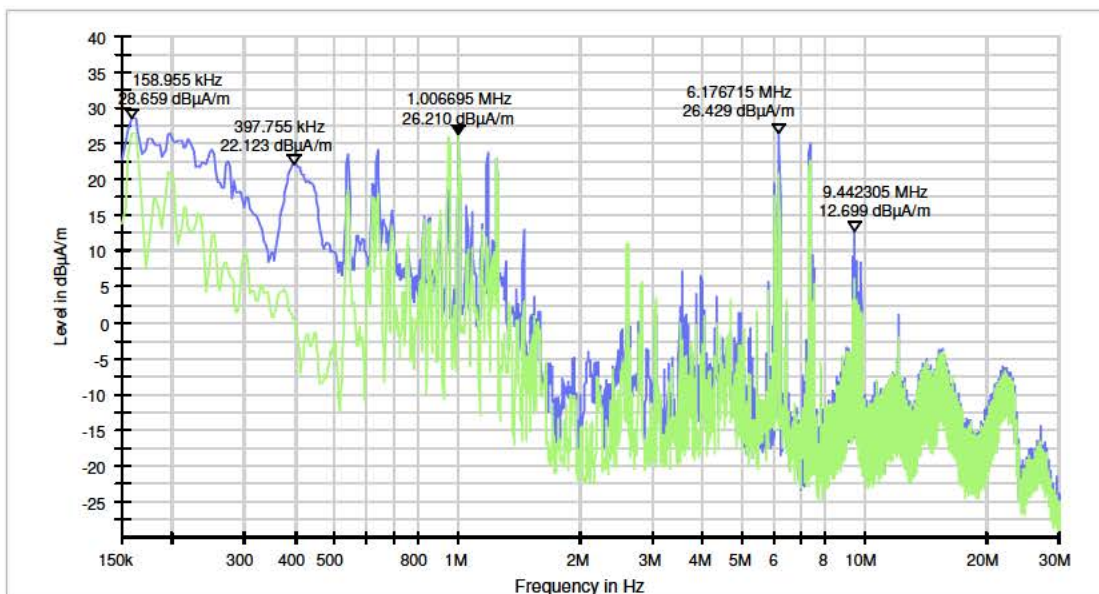

PK+_MAXH PK+_MAXH(1)@Ambient 150K-30M

Frequency range	Date & Time	Direction	Operating condition / Train type	Train serial #		Estimated current during test [A]		Distance to track [m]	Height - sensor [m]	Remark
				1	2	Min	Max			
9 KHz-150 KHz	2018/11/26 15:48	W => O	Stoptrain / Flirt	2501	2219	-517	1359	30	1	P-6, Y-axis
150 KHz-30 MHz	2018/11/26 16:48	W => O	Stoptrain / Flirt	2232	2504	-400	950	30	1	P-6, Y-axis

Measurement graphic (Y-axis):

Subrange	Step Size	Detectors	Bandwidth	Sweep Time	Preamp
9 kHz - 150 kHz	14.1 Hz	PK+	200 Hz	Coupled	0 dB
150 kHz - 30 MHz	2.985 kHz	PK+	9 kHz	Coupled	20 dB

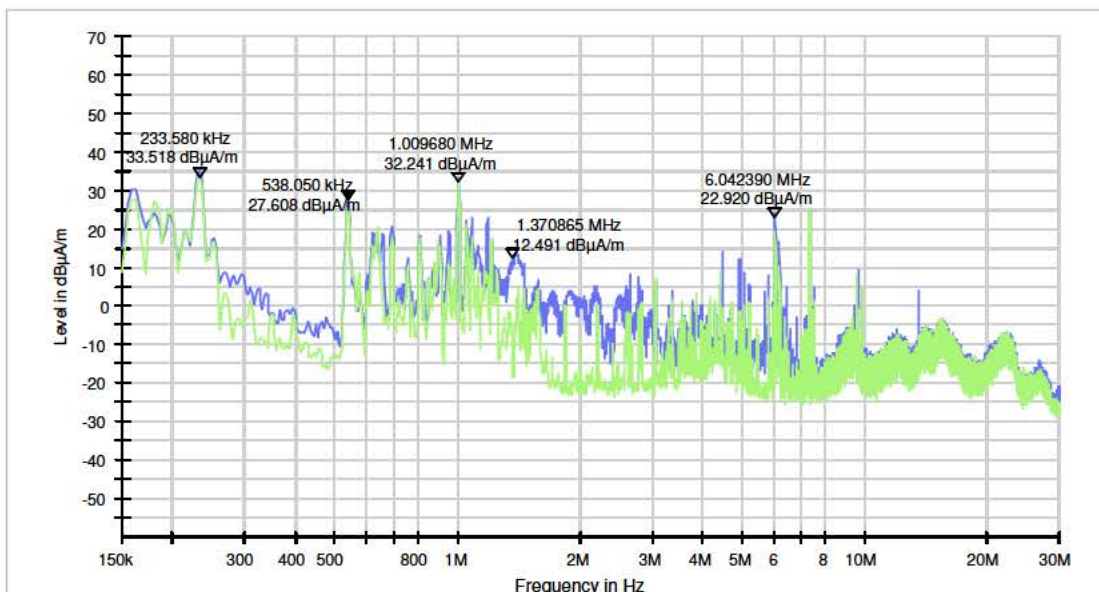
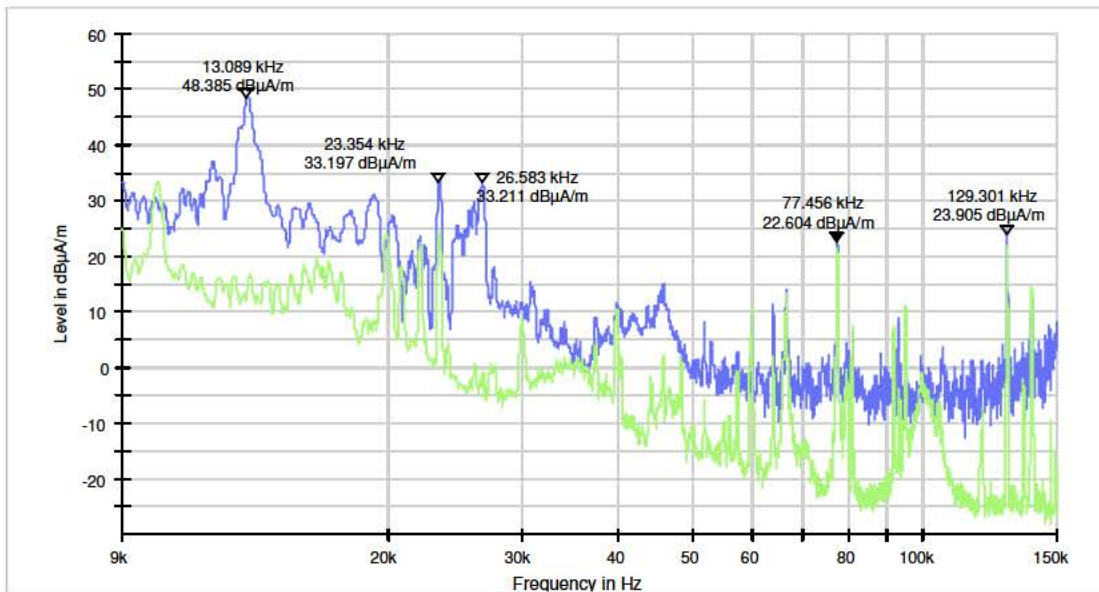

Frequency range	Date & Time	Direction	Operating condition / Train type	Train serial #		Estimated current during test [A]		Distance to track [m]	Height - sensor [m]	Remark
				1	2	Min	Max			
9 KHz-150 KHz	2018/11/26 15:27	O => W	Transit (IC) / ICM	4245	4028	---	---	30	1	P-6, Y-axis
150 KHz-30 MHz	2018/11/26 17:04	W => O	Transit (IC) / DDZ	7623	---	-100	60	30	1	P-6, Y-axis

Measurement graphic (Y-axis):

Subrange	Step Size	Detectors	Bandwidth	Sweep Time	Preamp
9 kHz - 150 kHz	14.1 Hz	PK+	200 Hz	Coupled	0 dB
150 kHz - 30 MHz	2.985 kHz	PK+	9 kHz	Coupled	20 dB

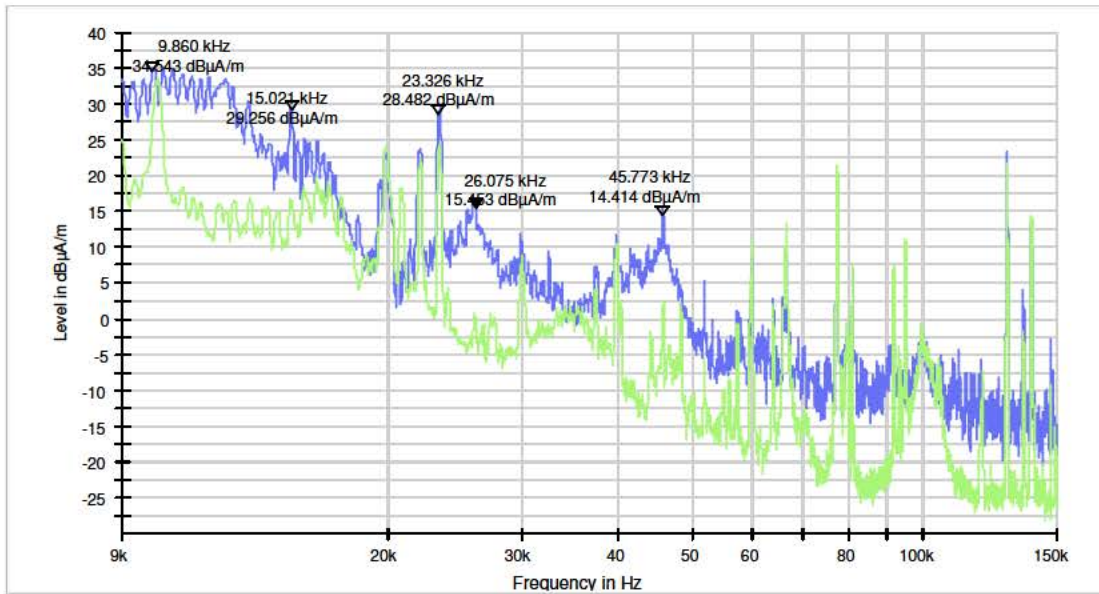

PK+_MAXH PK+_MAXH(1)@Ambient 9k - 150k

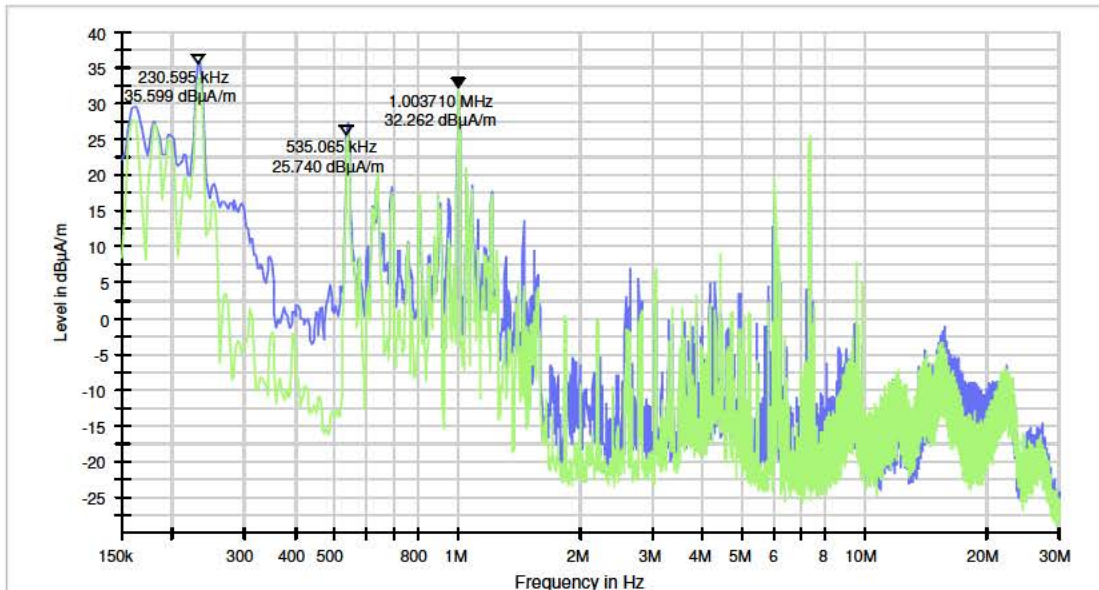

PK+_MAXH PK+_MAXH(1)@Ambient 150K30M

Frequency range	Date & Time	Direction	Operating condition / Train type	Train serial #		Estimated current during test [A]		Distance to track [m]	Height - sensor [m]	Remark
				1	2	Min	Max			
9 KHz-150 KHz	2018/11/26 17:50	W => O	Stoptrain / Flirt	---	---	---	---	30	1	P-6, Z-axis
150 KHz-30 MHz	2018/11/26 17:28	W => O	Stoptrain / Flirt	2525	2201	-600	10	30	1	P-6, Z-axis

Measurement graphic (Z-axis):

Subrange	Step Size	Detectors	Bandwidth	Sweep Time	Preamp
9 kHz - 150 kHz	14.1 Hz	PK+	200 Hz	Coupled	0 dB
150 kHz - 30 MHz	2.985 kHz	PK+	9 kHz	Coupled	20 dB

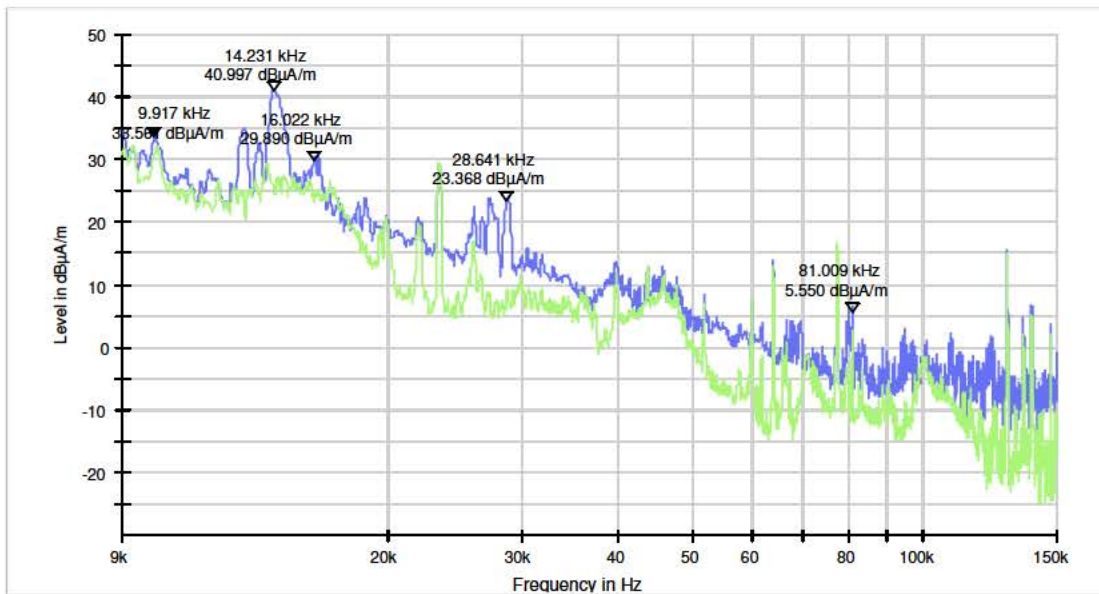

PK+_MAXH PK+_MAXH(1)@Ambient 9K150K

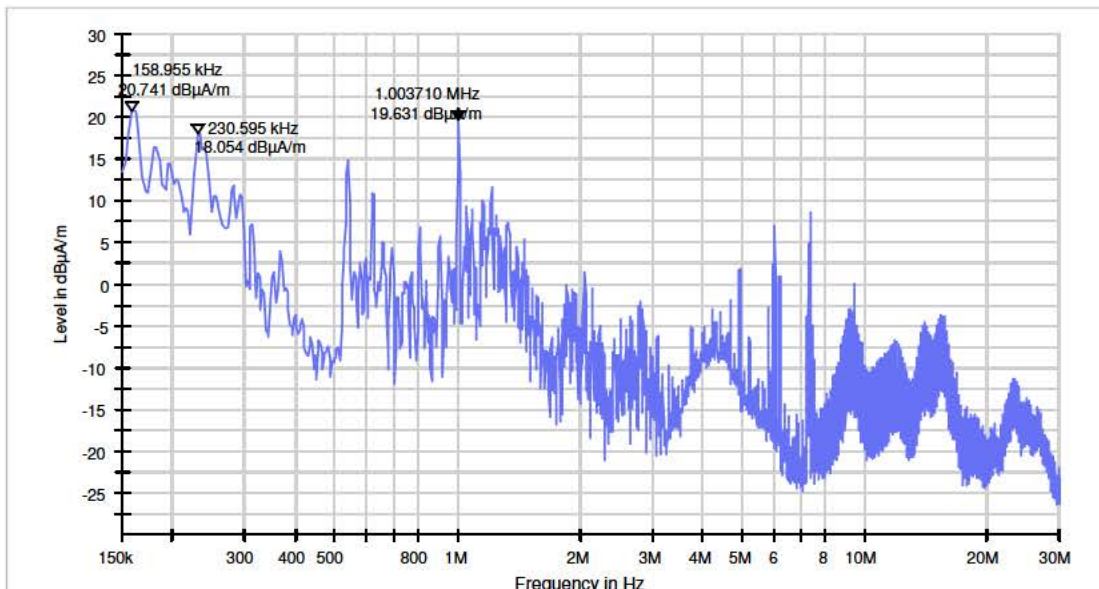

PK+_MAXH

Frequency range	Date & Time	Direction	Operating condition / Train type	Train serial #		Estimated current during test [A]		Distance to track [m]	Height - sensor [m]	Remark
				1	2	Min	Max			
9 KHz-150 KHz	2018/11/26 18:04	W => O	Transit (IC) / DDZ	---	---	---	---	30	1	P-6, Z-axis
150 KHz-30 MHz	2018/11/26 17:34	W => O	Transit (IC) / DDZ	7612	---	-250	20	30	1	P-6, Z-axis

Measurement graphic (Z-axis):

Subrange 9 kHz - 150 kHz 150 kHz - 30 MHz	Step Size 14.1 Hz 2.985 kHz	Detectors PK+ PK+	Bandwidth 200 Hz 9 kHz	Sweep Time Coupled Coupled	Preamp 0 dB 20 dB
--	--	--------------------------------	-------------------------------------	---	--------------------------------

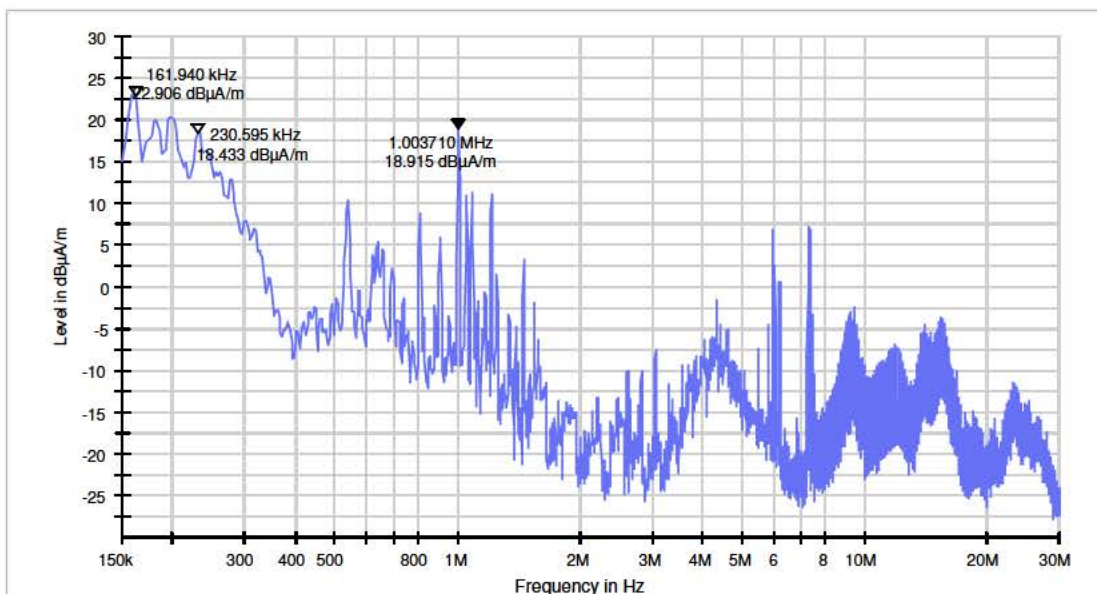
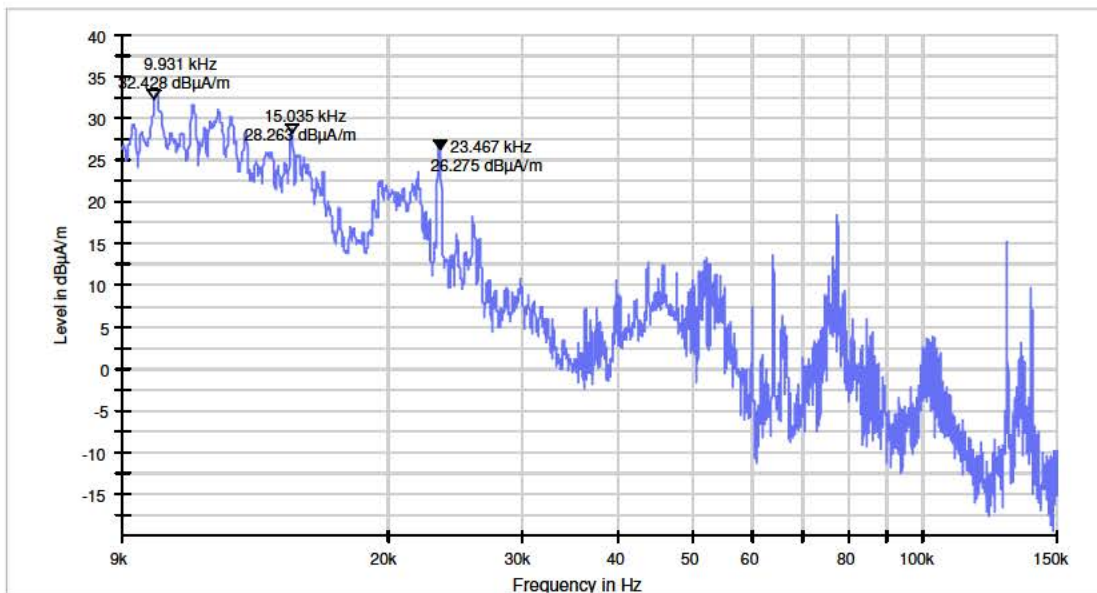

ANNEX 3: RADIATED ELECTRIC FIELD EMISSION MEASUREMENT RESULTS (30 – 1000 MHz)

A3.1 Stoptrain (acceleration)/ Transit / Braking, h=2 m., d=3 m. (30 – 1000 MHz)

Frequency range [MHz]	Date & Time	Direction	Operating condition / Train type	Train serial #		Estimated current during test [A]		Distance to track [m]	Height - antenna [m]	Remark
				1	2	Min	Max			
30-1000	2018/11/26 09:47	W => O ¹⁾	Stoptrain / Flirt	2217	2516	-225	1000	3	2	P-3 / HOR
30-1000	2018/11/26 10:48	W => O	Stoptrain / Flirt	2501	2219	-200	1100	3	2	P-3 / VER

¹⁾ Oss-West => Oss

Measurement graphic (P-3, Horizontal):

Subrange: 30 MHz - 1 GHz
 Step Size: 32.333 kHz
 Detectors: PK+
 Bandwidth: 120 kHz
 Sweep Time: Coupled
 Preamp: 20 dB

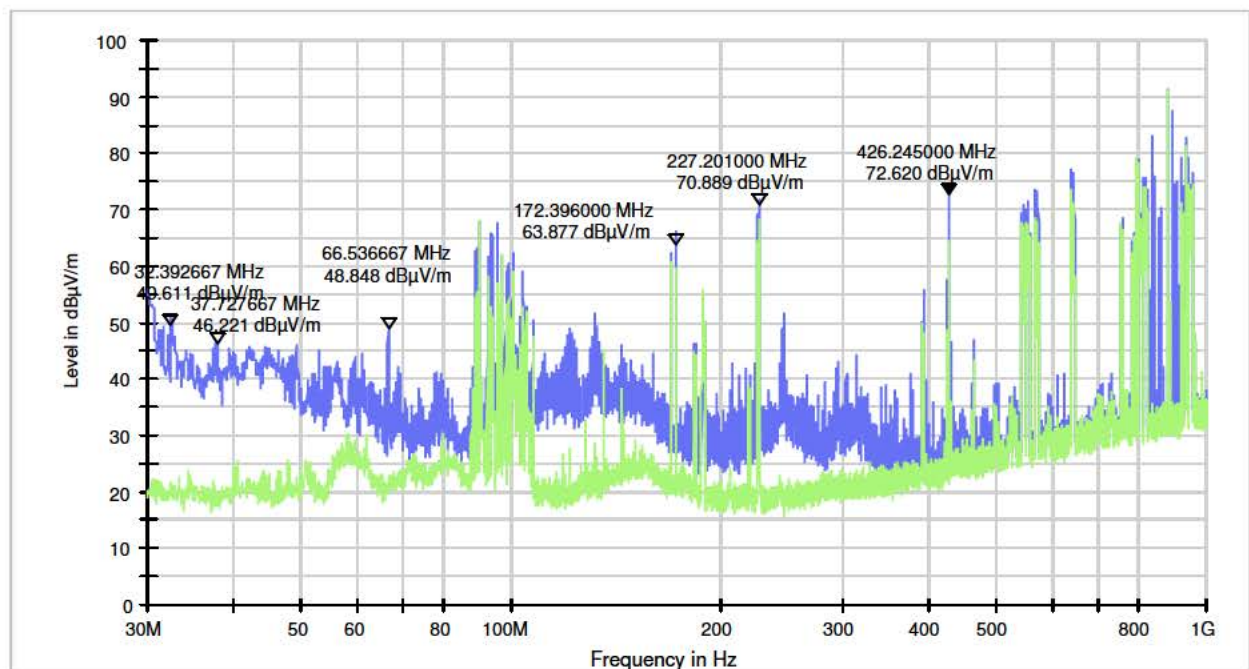

PK+_MAXH PK+_MAXH(1)@Ambient

Measurement graphic (P-3, Vertical):

Subrange	Step Size	Detectors	Bandwidth	Sweep Time	Preamp
30 MHz - 1 GHz	32.333 kHz	PK+	120 kHz	Coupled	20 dB

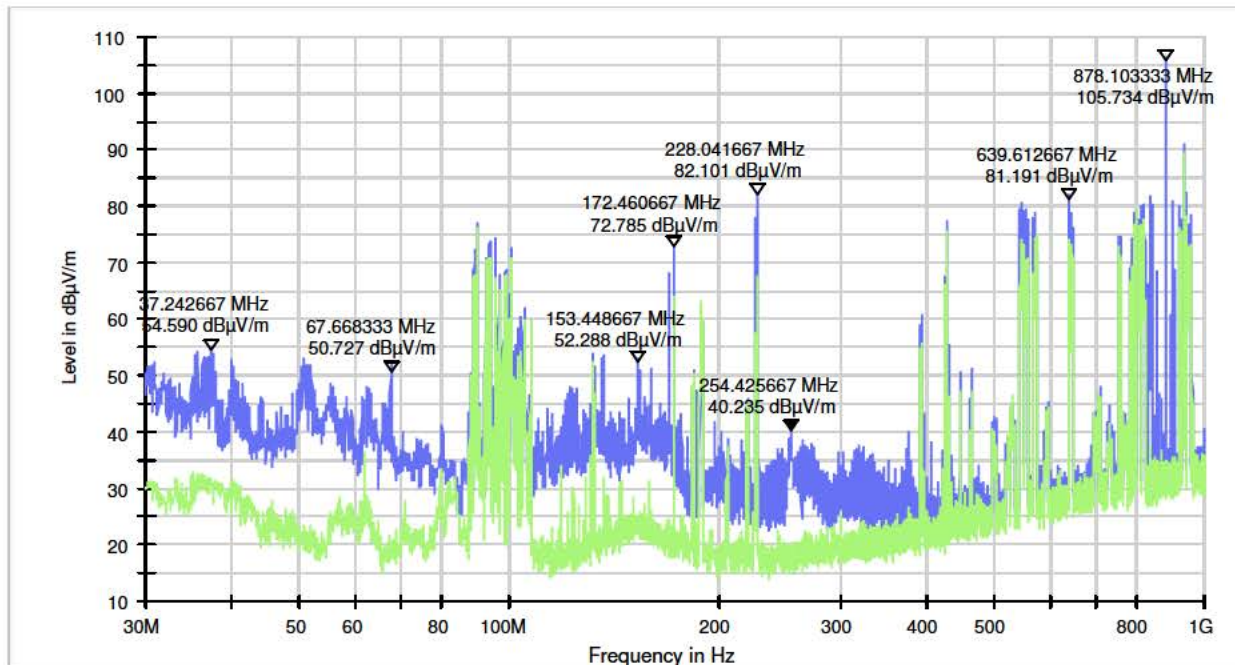

— PK+_MAXH — PK+_MAXH(1)@Ambient-VER

Frequency range [MHz]	Date & Time	Direction	Operating condition / Train type	Train serial #		Estimated current during test [A]		Distance to track [m]	Height - antenna [m]	Remark
				1	2	Min	Max			
30-1000	2018/11/26 10:04	W => O	Transit / ICM	4063	4047	-250	120	3	2	P-3 / HOR
30-1000	2018/11/26 10:34	W => O	Transit / DDZ	7608	---	-275	40	3	2	P-3 / VER

Subrange 30 MHz - 1 GHz Step Size 32.333 kHz Detectors PK+ Bandwidth 120 kHz Sweep Time Coupled Preamp 20 dB

Measurement graphic (P-3, Horizontal):

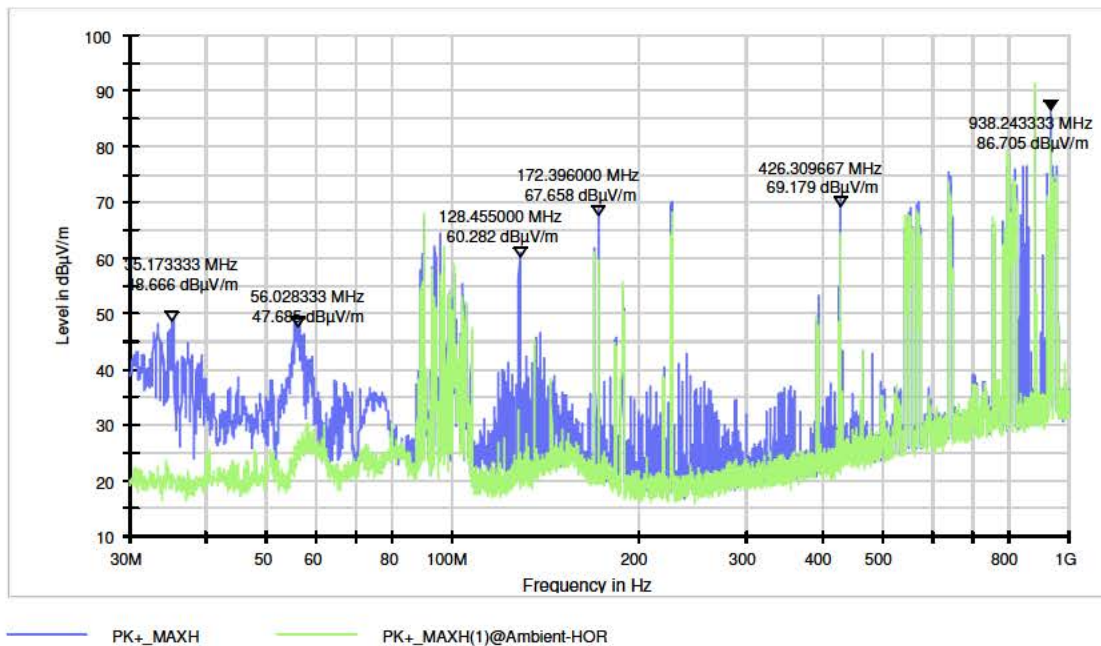

Measurement graphic (P-3, Vertical):

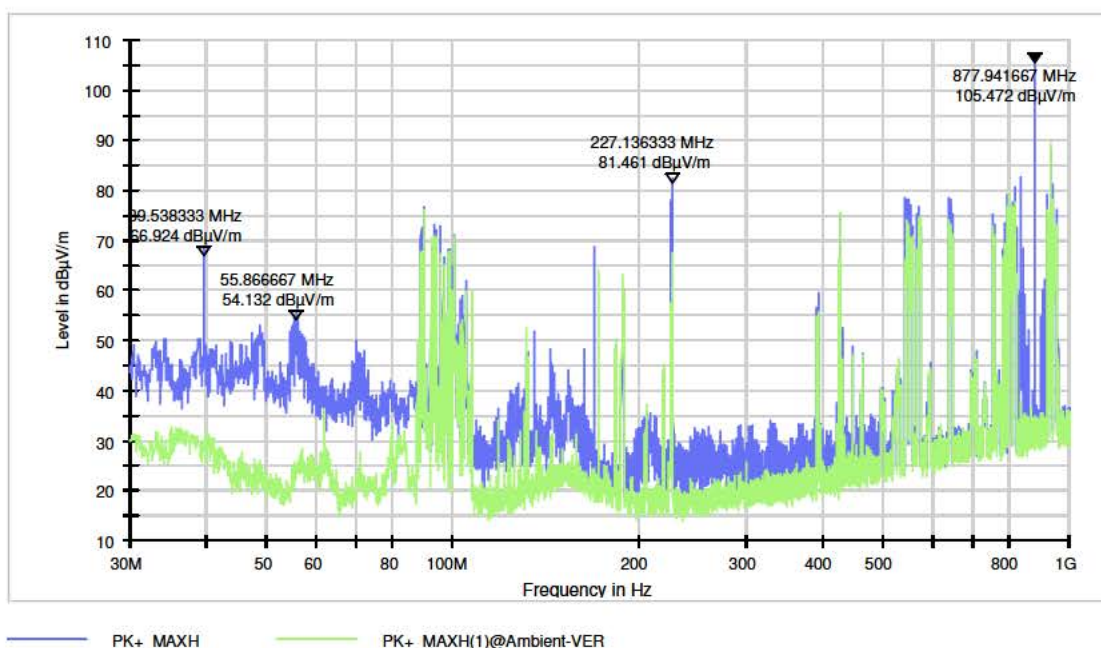

Frequency range [MHz]	Date & Time	Direction	Operating condition / Train type	Train serial #		Estimated current during test [A]		Distance to track [m]	Height - antenna [m]	Remark
				1	2	Min	Max			
30-1000	2018/11/26 09:18	O => W	Braking@track2 / Flirt	---	---	---	---	3	2	P-3 / HOR

Measurement graphic (P-3, Horizontal):

Subrange 30 MHz - 1 GHz Step Size 32.333 kHz Detectors PK+ Bandwidth 120 kHz Sweep Time Coupled Preamp 20 dB

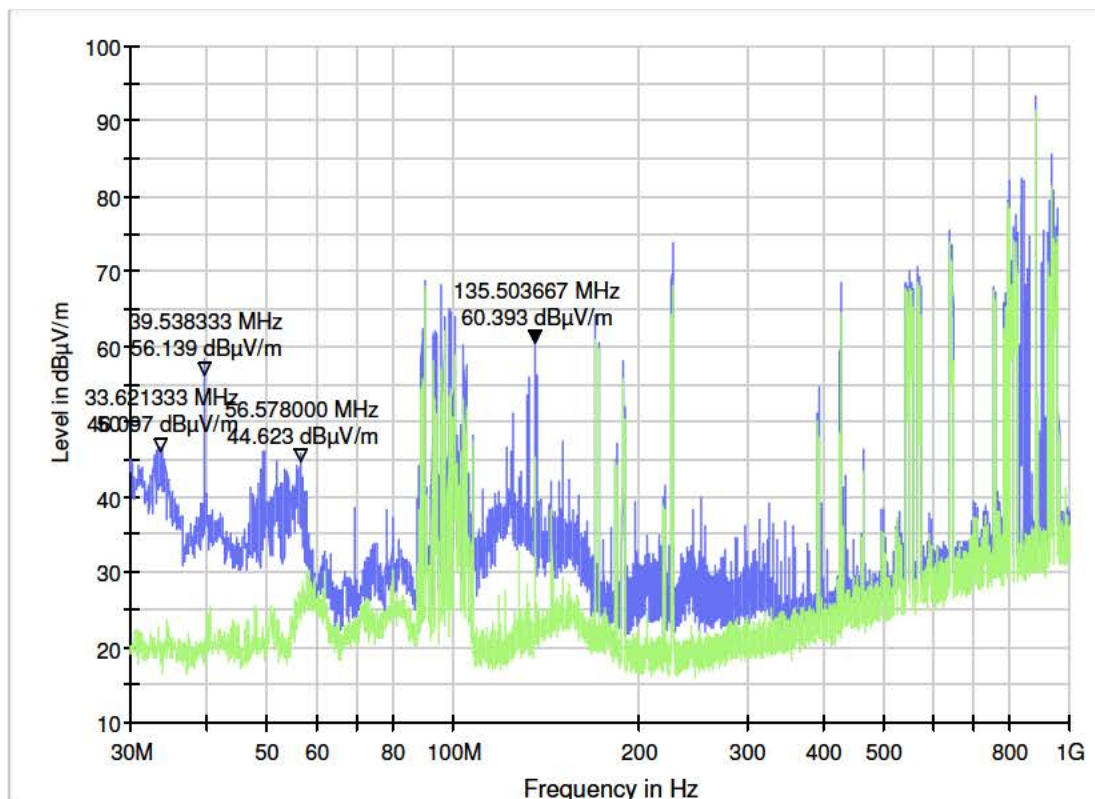

— PK+_MAXH — PK+_MAXH(1)@Ambient-HOR

A3.2 Stoptrain (acceleration)/ Transit / Braking, Barrier, h=2.5 m., d=10 m. (30 – 1000 MHz)

Frequency range [MHz]	Date & Time	Direction	Operating condition / Train type	Train serial #		Estimated current during test [A]		Distance to track [m]	Height - antenna [m]	Remark
				1	2	Min	Max			
30-1000	2018/11/26 11:50	W => O	Stoptrain / Flirt	2232	2504	-370	900	10	2.5	P-5 / HOR
30-1000	2018/11/26 11:16	W => O	Stoptrain / Flirt	2509	2212	-750	600	10	2.5	P-5 / VER ¹⁾

¹⁾ Stoptrain (acceleration) on track SP1ADc and braking train on track SP2ADC.

Subrange	Step Size	Detectors	Bandwidth	Sweep Time	Preamp
30 MHz - 1 GHz	32.333 kHz	PK+	120 kHz	Coupled	20 dB

Measurement graphic (P-5, Horizontal):

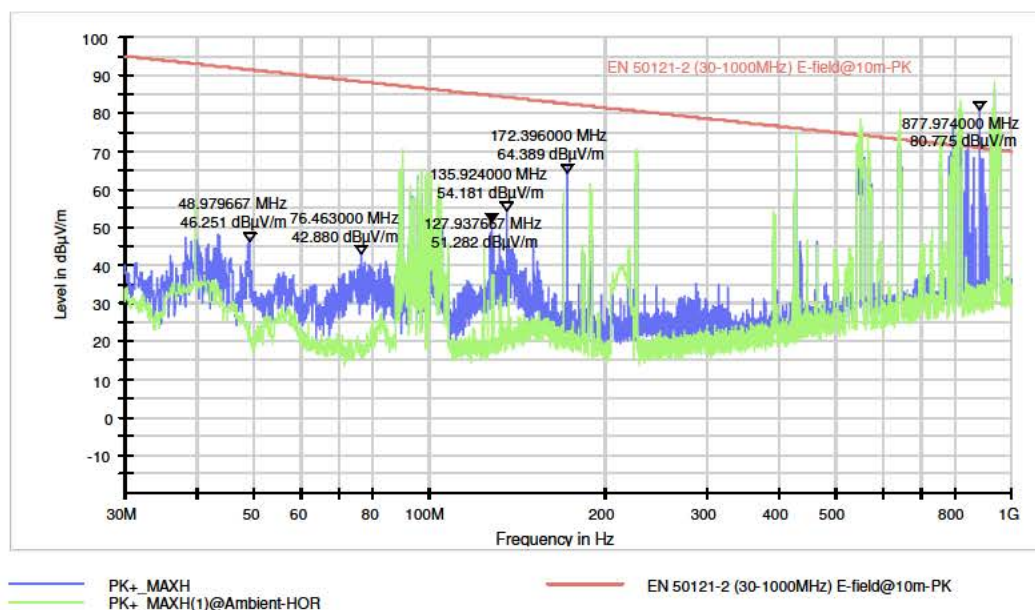

Measurement graphic (P-5, Vertical):

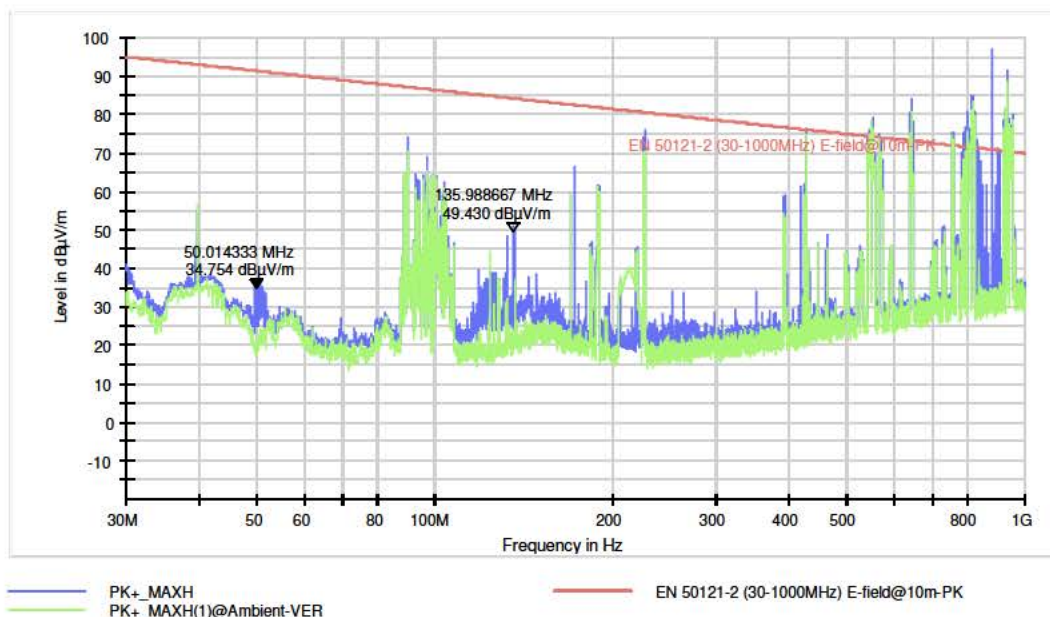

Frequency range [MHz]	Date & Time	Direction	Operating condition / Train type	Train serial #		Estimated current during test [A]		Distance to track [m]	Height - antenna [m]	Remark
				1	2	Min	Max			
30-1000	2018/11/26 12:05	W => O	Transit / ICM	4245	4028	-20	120	10	2.5	P-5 / HOR
30-1000	2018/11/26 11:34	W => O	Transit / DDZ	7612	---	-225	-50	10	2.5	P-5 / VER

Subrange 30 MHz - 1 GHz Step Size 32.333 kHz Detectors PK+ Bandwidth 120 kHz Sweep Time Coupled Preamp 20 dB

Measurement graphic (P-5, Horizontal):

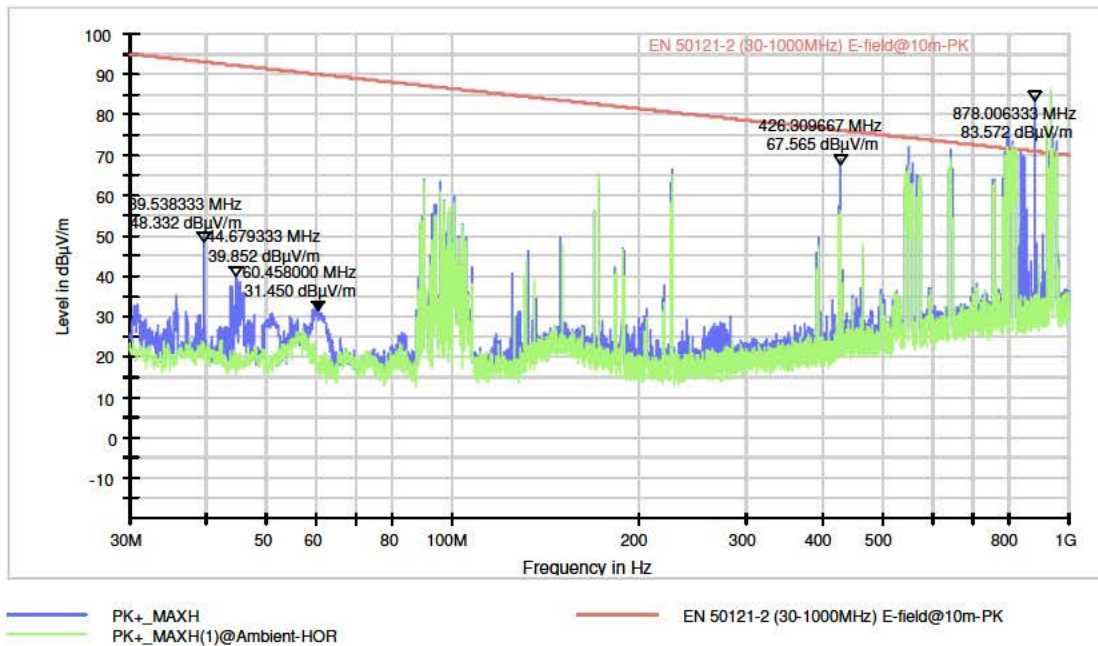

Measurement graphic (P-5, Vertical):

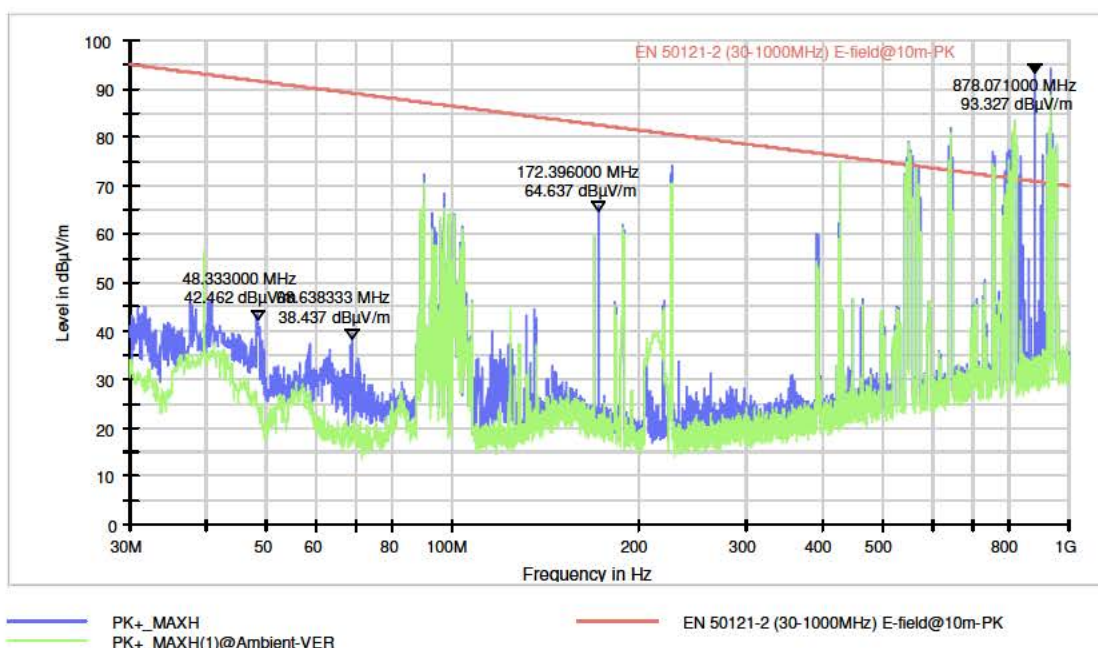

Frequency range [MHz]	Date & Time	Direction	Operating condition (Barrier)	Train serial #		Estimated current during test [A]		Distance to barrier [m]	Height - antenna [m]	Remark
				1	2	Min	Max			
30-1000	2018/11/26 11:58	W => O	Closed	N/A	N/A	N/A	N/A	10	2	P-5, HOR

Measurement graphic (P-5, Horizontal):

Subrange 30 MHz - 1 GHz Step Size 32.333 kHz Detectors PK+ Bandwidth 120 kHz Sweep Time Coupled Preamp 20 dB

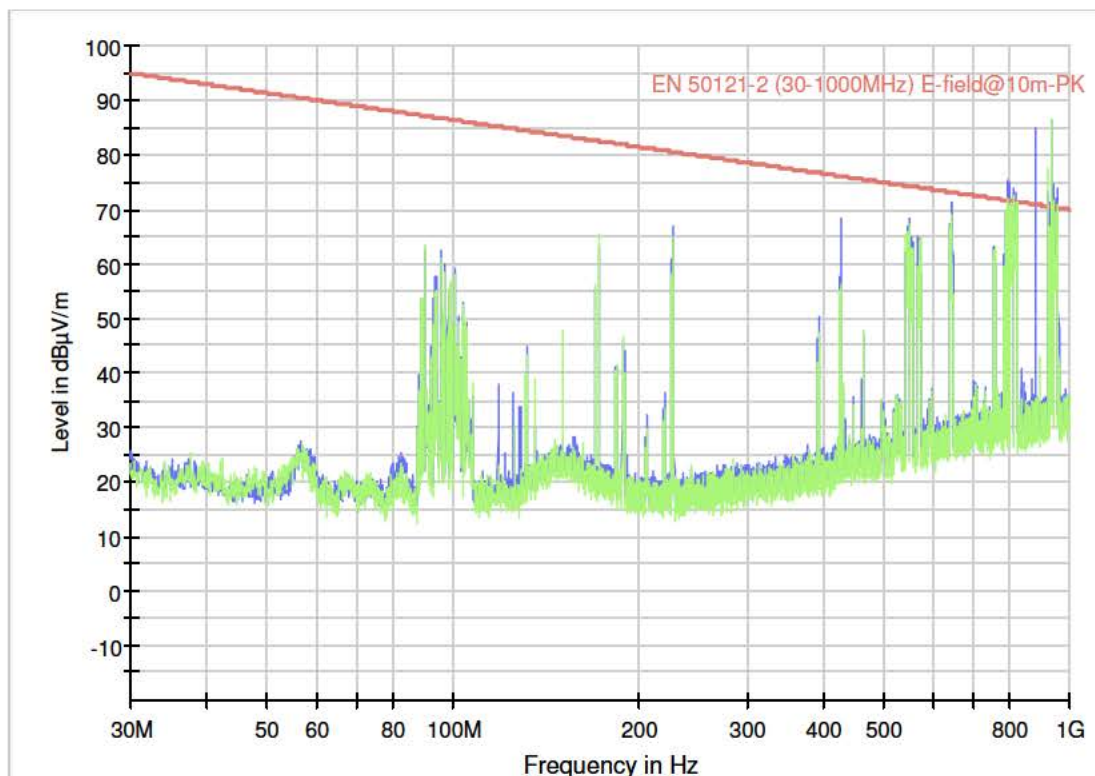

— PK+_MAXH — EN 50121-2 (30-1000MHz) E-field@10m-PK
 — PK+_MAXH(1)@Ambient-HOR

A3.3 Stoptrain (acceleration)/ Transit / Braking, Barrier, h=3 m., d=30 m. (30 – 1000 MHz)

Frequency range [MHz]	Date & Time	Direction	Operating condition / Train type	Train serial #		Estimated current during test [A]		Distance to track [m]	Height - antenna [m]	Remark
				1	2	Min	Max			
30-1000	2018/11/26 13:48	W => O	Stoptrain / Flirt	2209	---	-570	260	30	3	P-6 / HOR
30-1000	2018/11/26 13:17	W => O	Stoptrain / Flirt	2216	---	-600	250	30	3	P-6 / VER

Subrange 30 MHz - 1 GHz Step Size 32.333 kHz Detectors PK+ Bandwidth 120 kHz Sweep Time Coupled Preamp 20 dB

Measurement graphic (P-6, Horizontal):

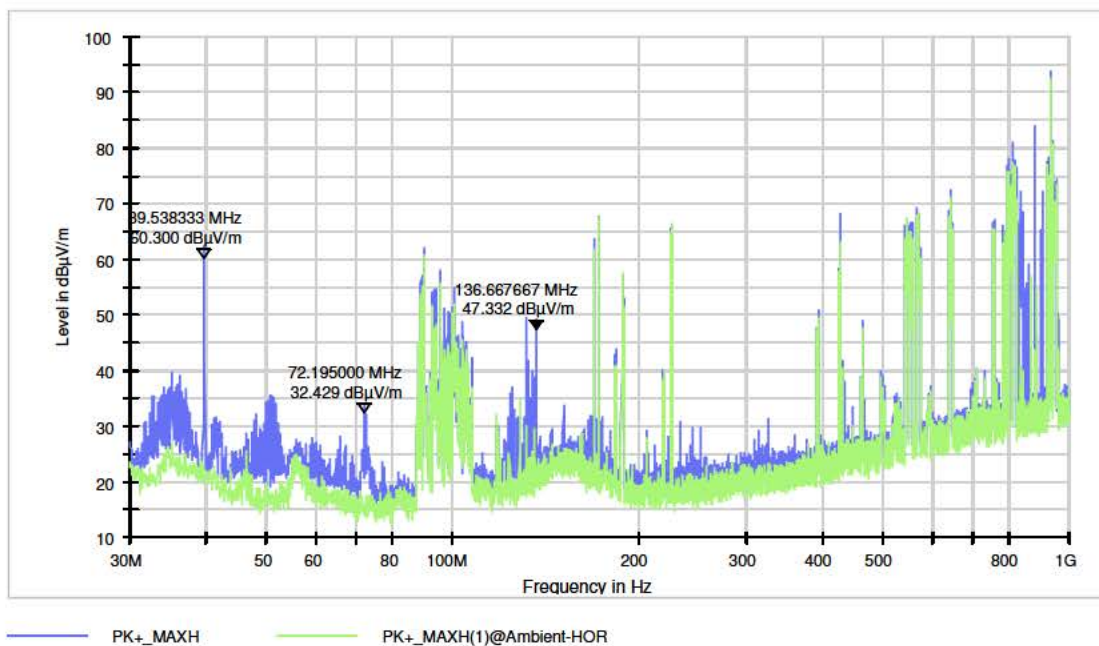

Measurement graphic (P-6, Vertical):

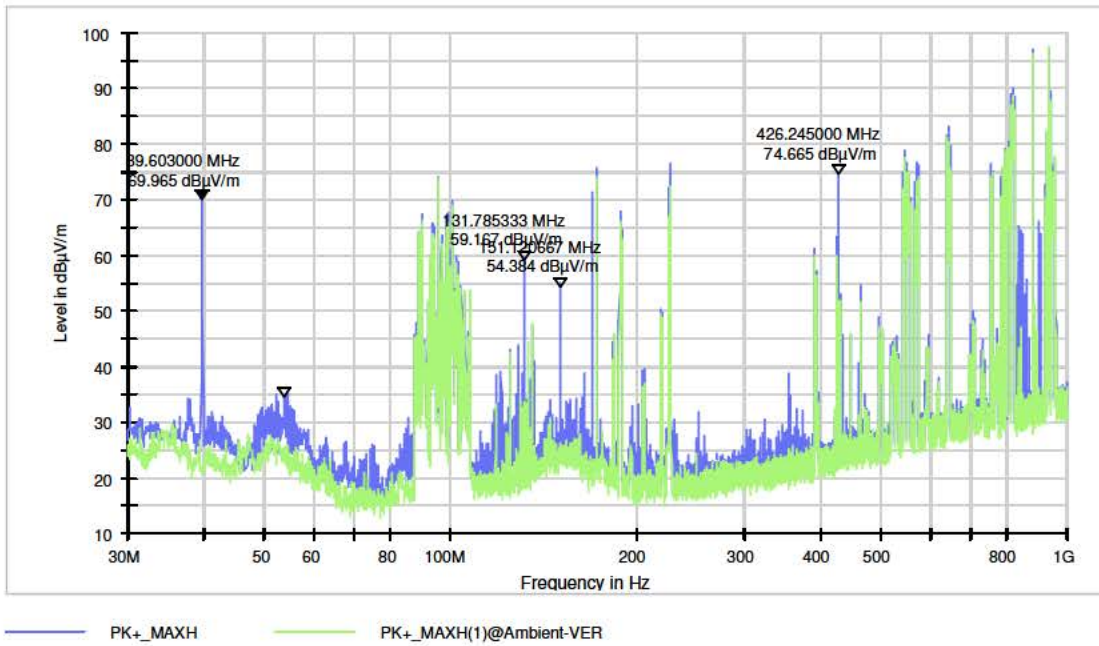

Frequency range [MHz]	Date & Time	Direction	Operating condition / Train type	Train serial #		Estimated current during test [A]		Distance to track [m]	Height - antenna [m]	Remark
				1	2	Min	Max			
30-1000	2018/11/26 14:03	W => O	Transit / DDZ	7614	---	-120	-10	30	3	P-6 / HOR
30-1000	2018/11/26 13:34	W => O	Transit / DDZ	7616	---	-300	100	30	3	P-6 / VER

Subrange: 30 MHz - 1 GHz Step Size: 32.333 kHz Detectors: PK+ Bandwidth: 120 kHz Sweep Time: Coupled Preamp: 20 dB

Measurement graphic (P-6, Horizontal):

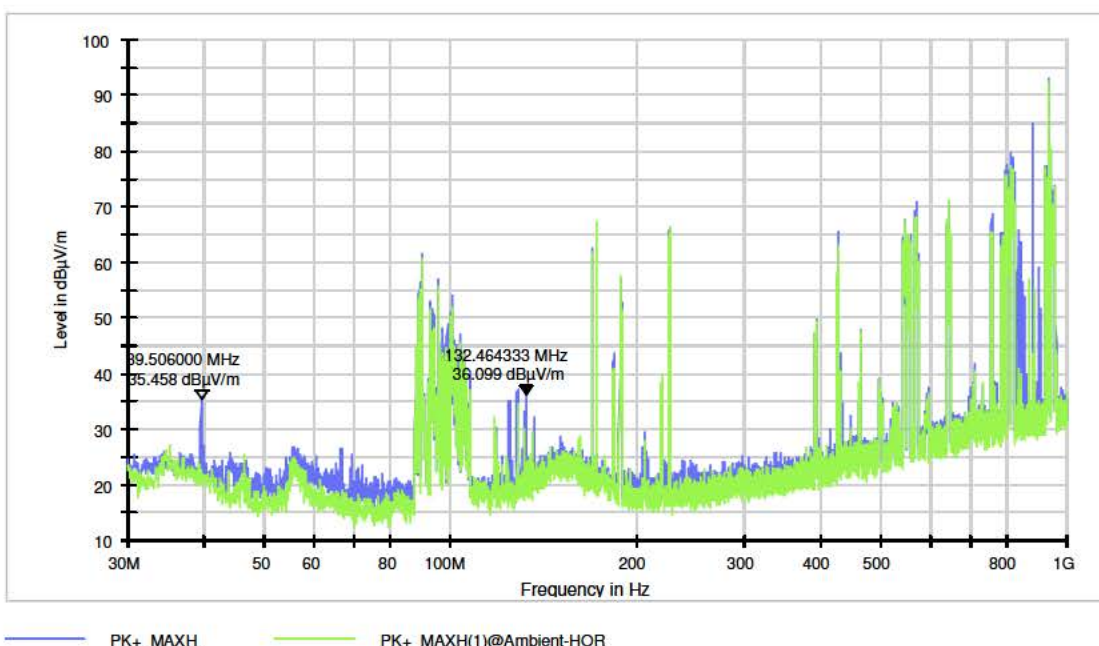

Measurement graphic (P-6, Vertical):

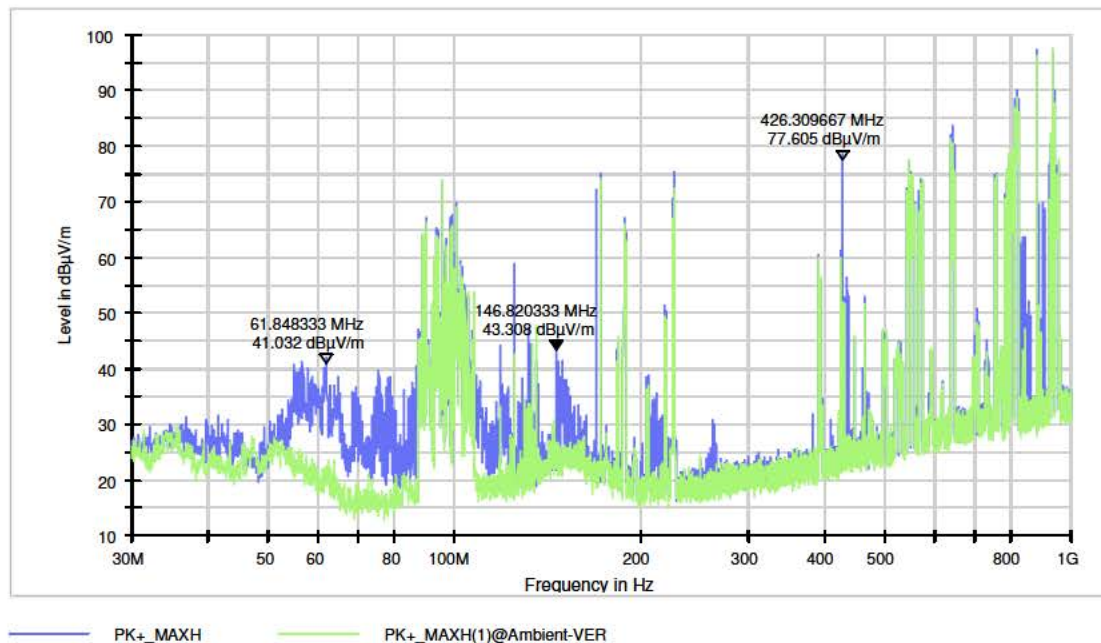

A3.4 Stoptrain (acceleration)/ Transit / Braking, Barrier and surrounding, h=3 m., d=30 m. (30 – 1000 MHz)

The measurements given below have been obtained by doing longterm measurements using “max-hold” function of the spectrum analyzer equipment. The measurements have been done when the antenna has been positioned to “East”, “South” and “West” direction respectively. The purpose of these measurements was to identify the RF fields from the surrounding of the Railway Crossing.

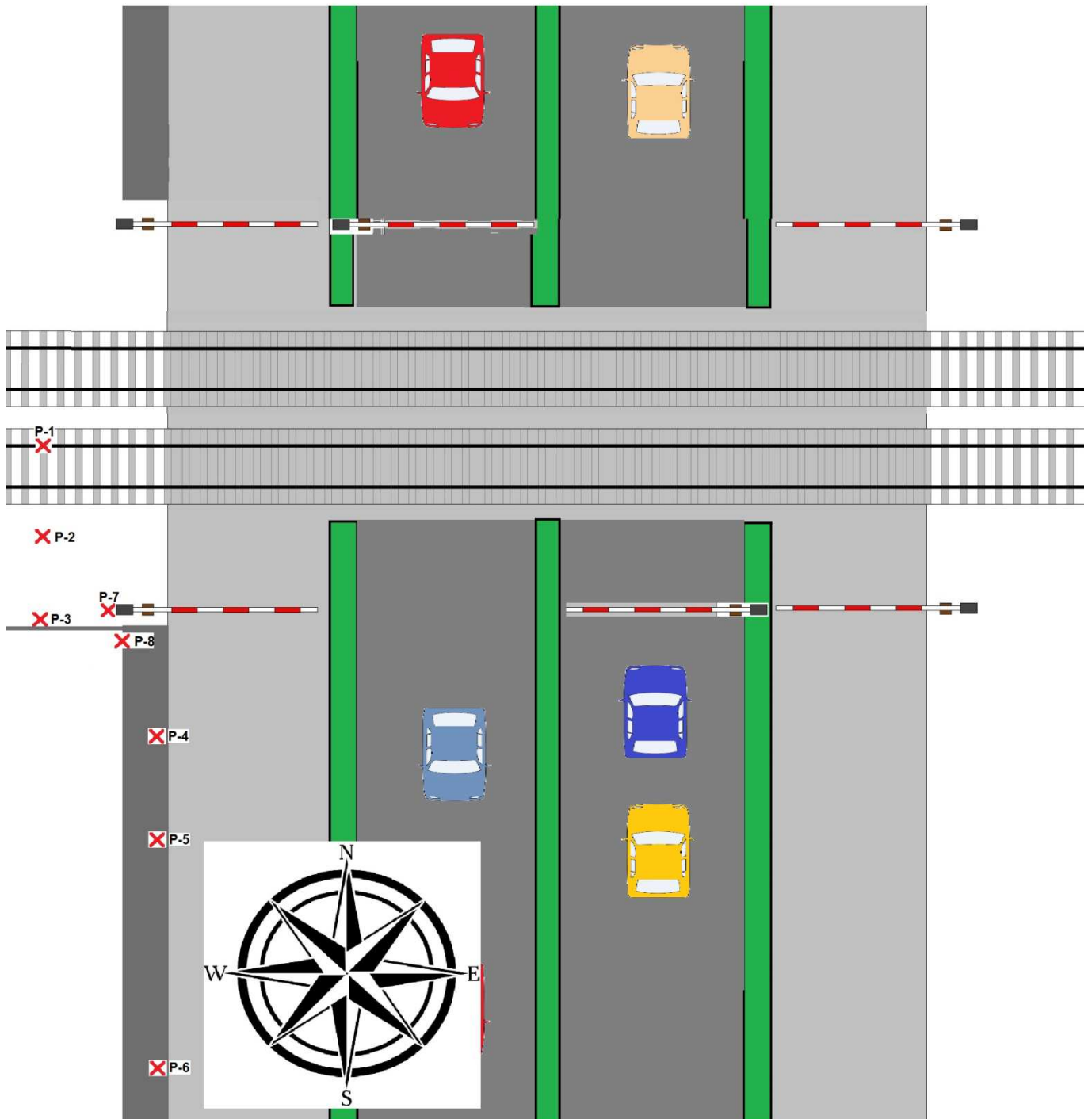

Measurement graphic (P-6, East-direction, Horizontal):

Subrange	Step Size	Detectors	Bandwidth	Sweep Time	Preamp
30 MHz - 1 GHz	32.333 kHz	PK+	120 kHz	Coupled	20 dB

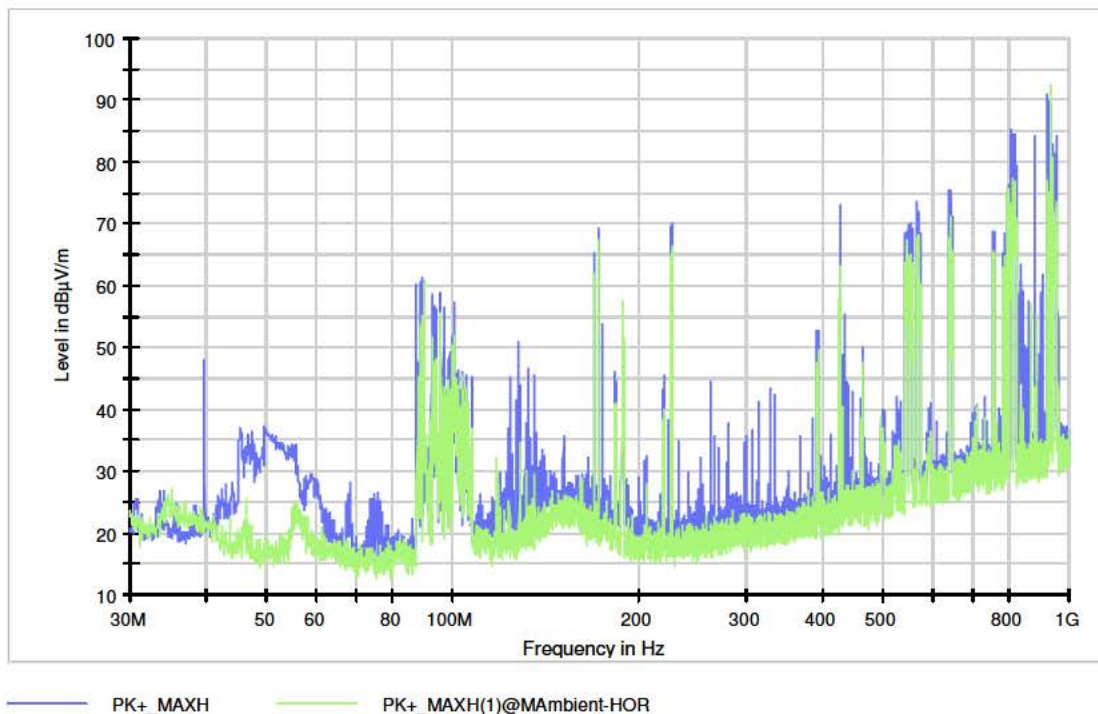

Measurement graphic (P-6, East-direction, Vertical):

Subrange	Step Size	Detectors	Bandwidth	Sweep Time	Preamp
30 MHz - 1 GHz	32.333 kHz	PK+	120 kHz	Coupled	20 dB

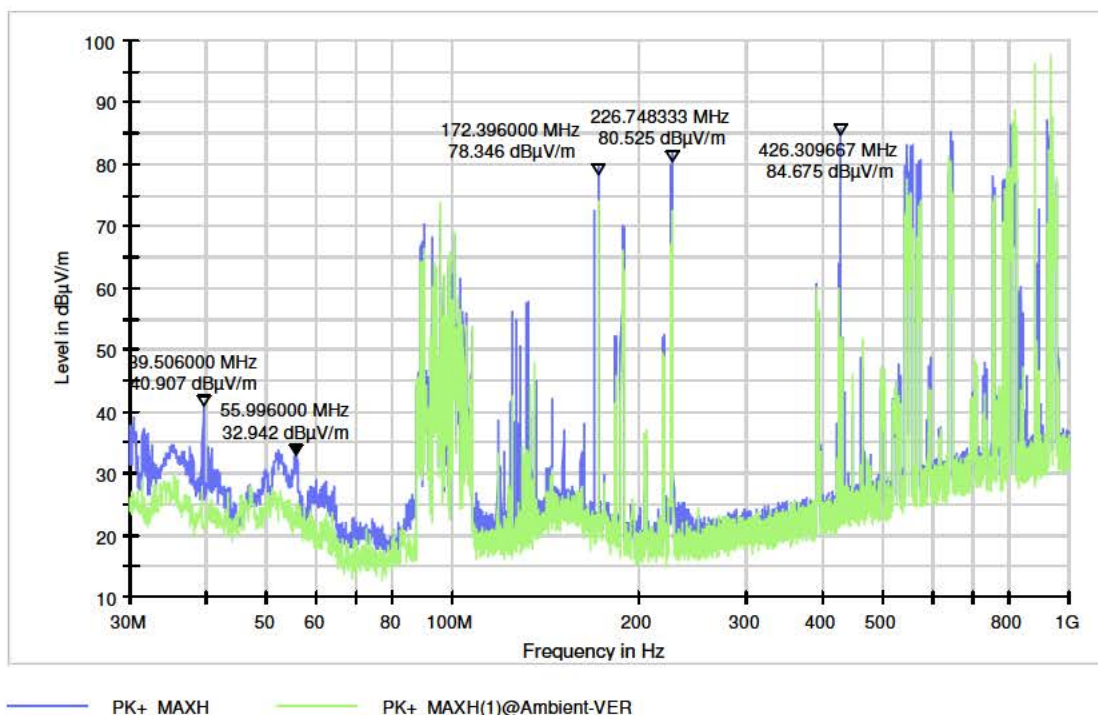

Measurement graphic (P-6, South-direction, Horizontal):

Subrange	Step Size	Detectors	Bandwidth	Sweep Time	Preamp
30 MHz - 1 GHz	32.333 kHz	PK+	120 kHz	Coupled	20 dB

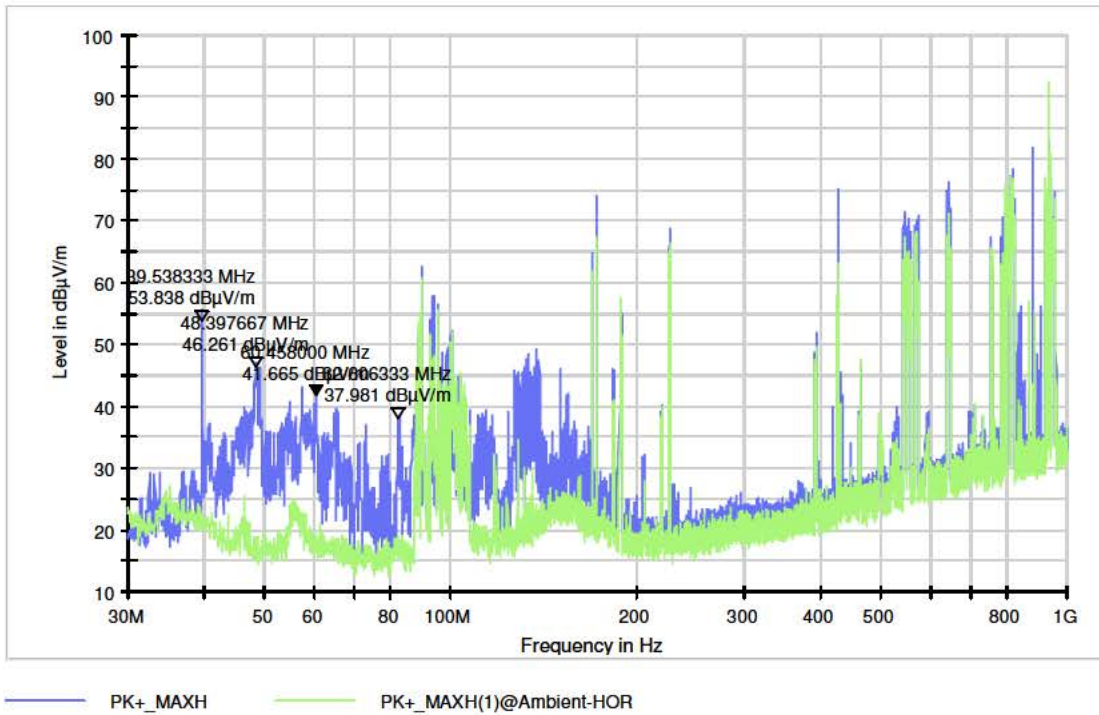

Measurement graphic (P-6, South-direction, Vertical):

Subrange	Step Size	Detectors	Bandwidth	Sweep Time	Preamp
30 MHz - 1 GHz	32.333 kHz	PK+	120 kHz	Coupled	20 dB

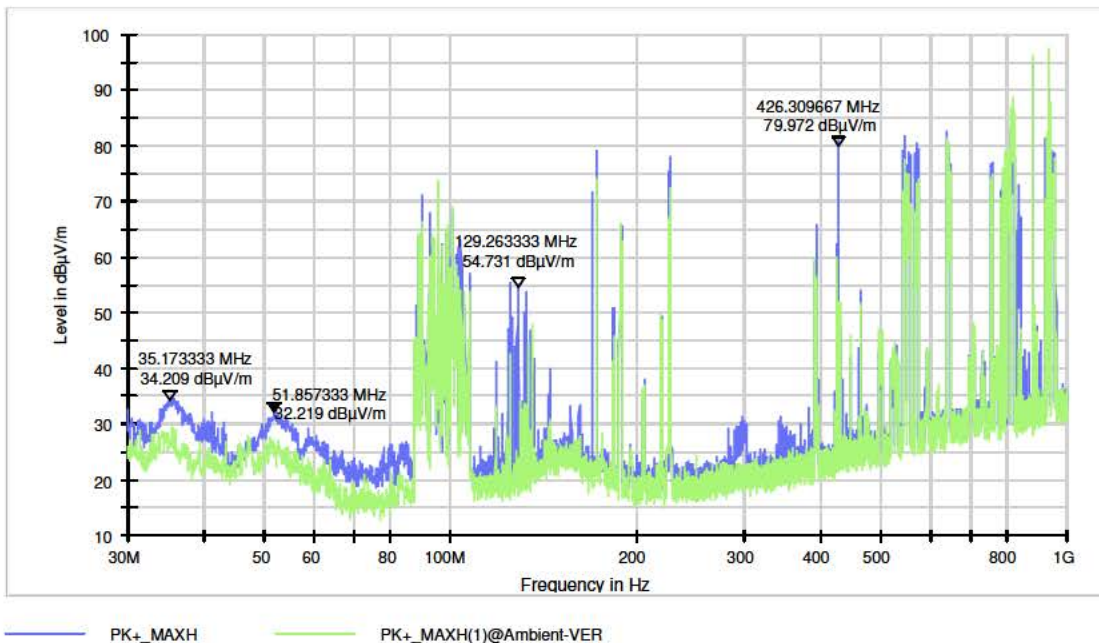

Measurement graphic (P-6, West-direction, Horizontal):

Subrange	Step Size	Detectors	Bandwidth	Sweep Time	Preamp
30 MHz - 1 GHz	32.333 kHz	PK+	120 kHz	Coupled	20 dB

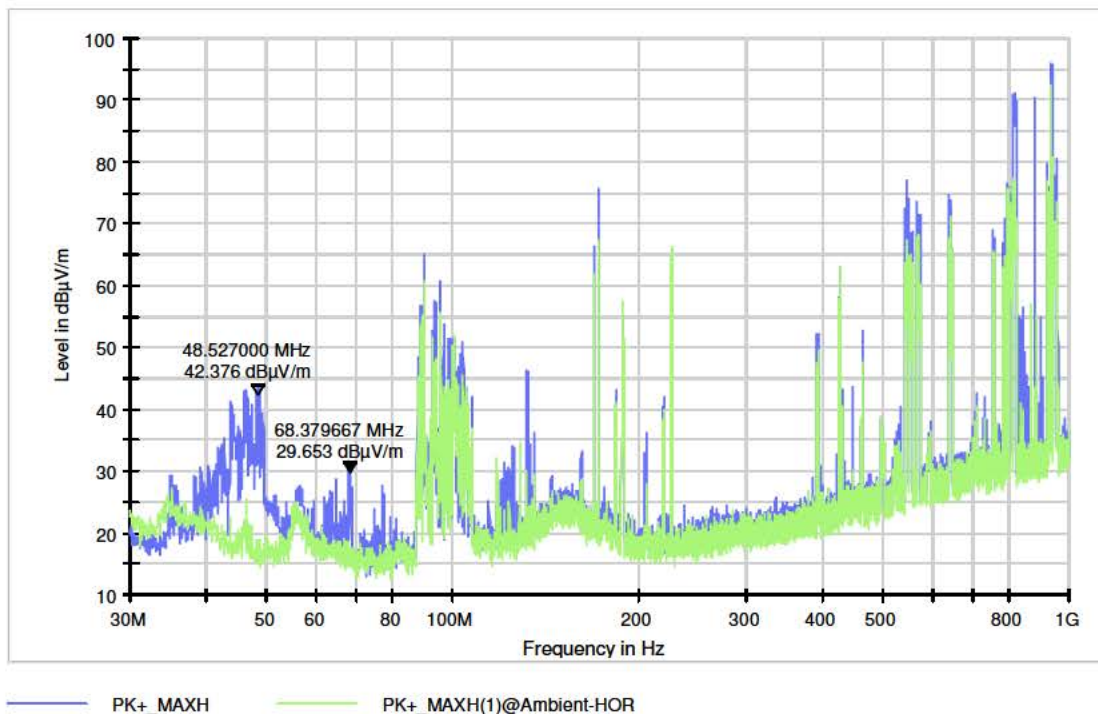

Measurement graphic (P-6, West-direction, Vertical):

Subrange	Step Size	Detectors	Bandwidth	Sweep Time	Preamp
30 MHz - 1 GHz	32.333 kHz	PK+	120 kHz	Coupled	20 dB

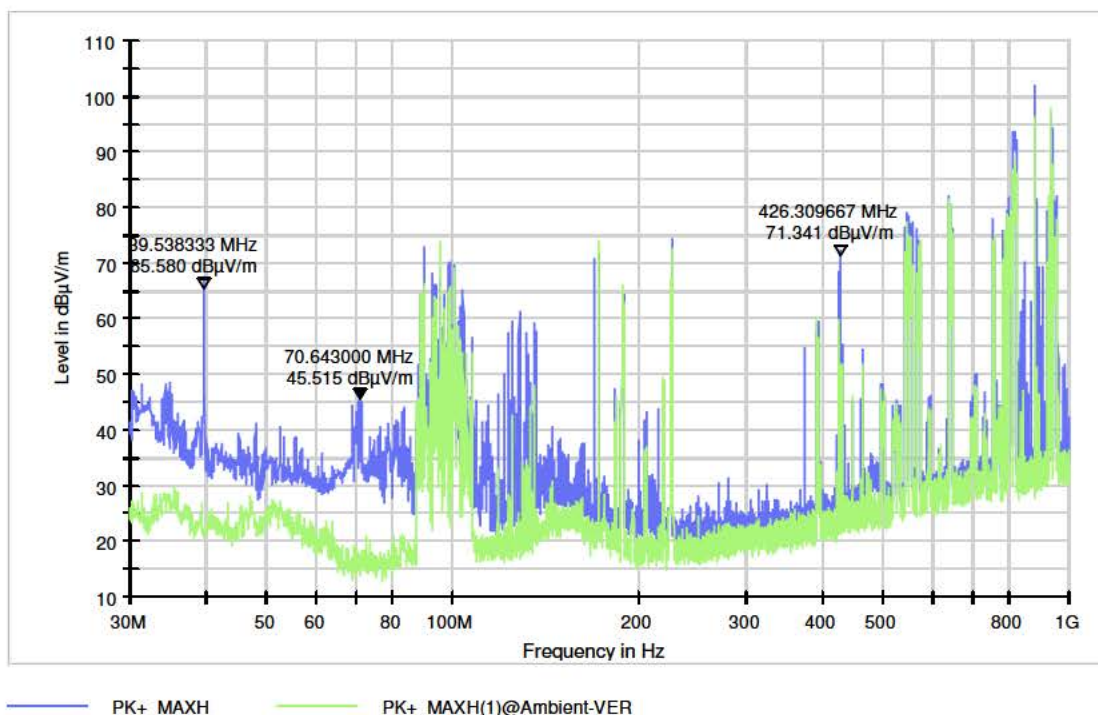

ANNEX 4: RADIATED ELECTRIC FIELD EMISSION MEASUREMENT RESULTS (1 – 6 GHz)

A4.1 Stoptrain (acceleration)/ Transit / Braking, h=2 m., d=3 m. (1 - 6 GHz)

Frequency range [GHz]	Date & Time	Direction	Operating condition / Train type	Train serial #		Estimated current during test [A]		Distance to track [m]	Height - antenna [m]	Remark
				1	2	Min	Max			
1 - 6	2018/11/26 11:16	W => O ¹⁾	Stoptrain / Flirt	2509	2212	-750	600	3	2	P-3 / HOR
1 - 6	2018/11/26 11:50	W => O	Stoptrain / Flirt	2232	2504	-370	900	3	2	P-3 / VER

¹⁾ Oss-West => Oss

Measurement graphic (P-3, Horizontal):

Subrange 1 GHz - 6 GHz Step Size 250 kHz Detectors PK+ Bandwidth 1 MHz Sweep Time Coupled Preamp 20 dB

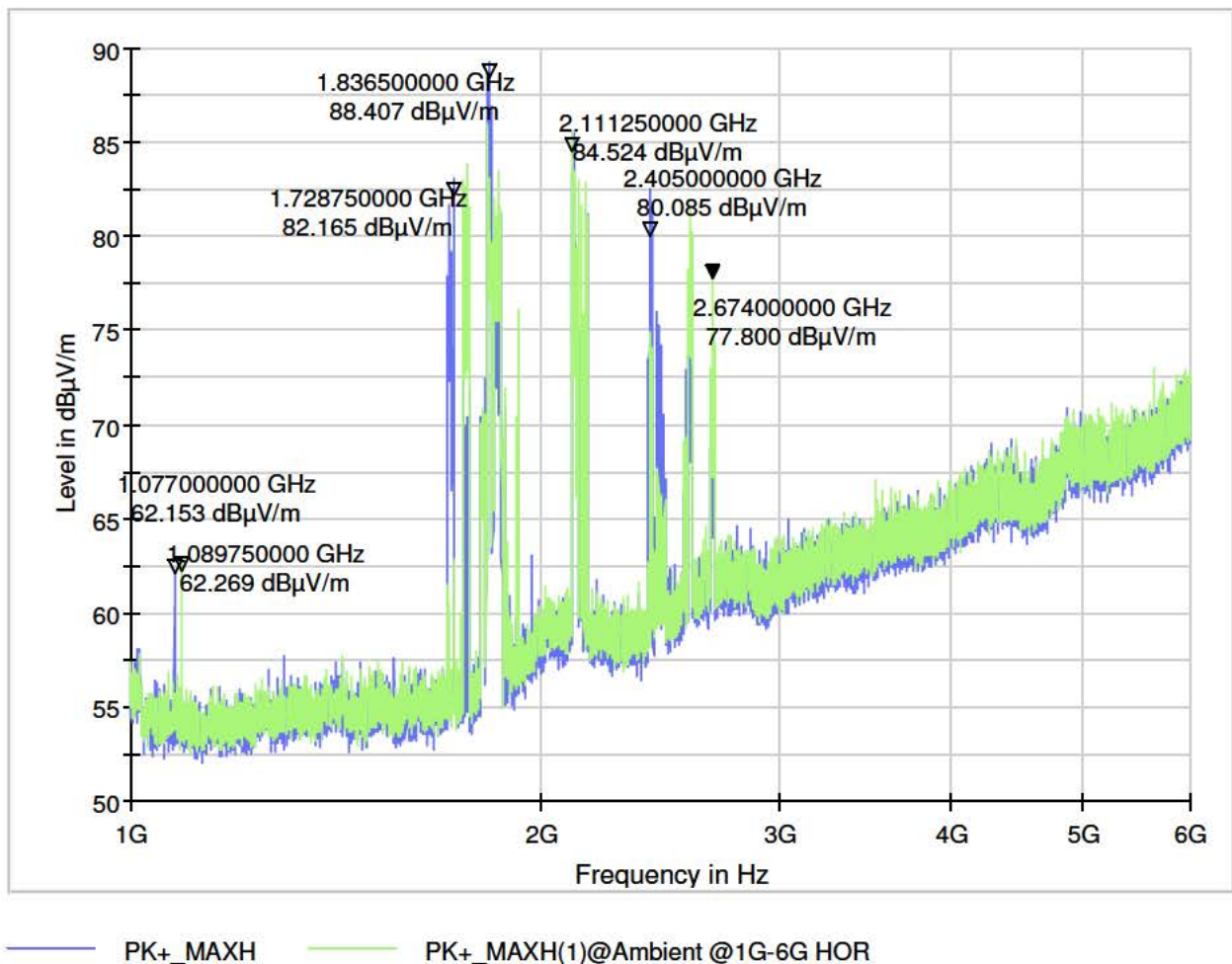

Measurement graphic (P-3, Vertical):

Subrange	Step Size	Detectors	Bandwidth	Sweep Time	Preamp
1 GHz - 6 GHz	250 kHz	PK+	1 MHz	Coupled	20 dB

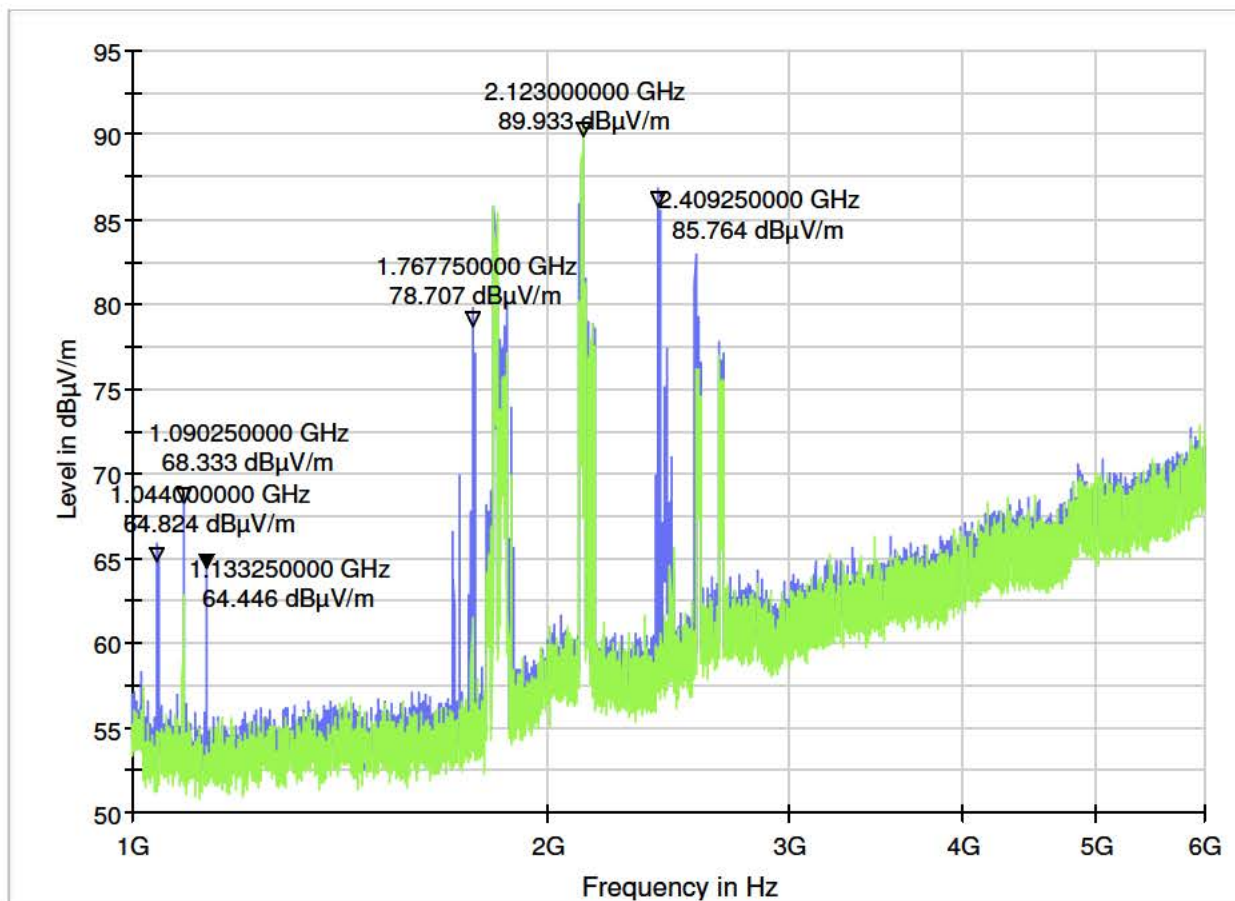

— PK+_MAXH — PK+_MAXH(1)@Ambient @1G-6G VER@3m-PK 11-39

Frequency range [GHz]	Date & Time	Direction	Operating condition / Train type	Train serial #		Estimated current during test [A]		Distance to track [m]	Height - antenna [m]	Remark
				1	2	Min	Max			
1 - 6	2018/11/26 11:35	W => O	Transit / DDZ	7612	---	-225	-50	3	2	P-3 / HOR
1 - 6	2018/11/26 12:05	W => O	Transit / ICM	4245	4028	-20	120	3	2	P-3 / VER

Measurement graphic (P-3, Horizontal):

Subrange 1 GHz - 6 GHz Step Size 250 kHz Detectors PK+ Bandwidth 1 MHz Sweep Time Coupled Preamp 20 dB

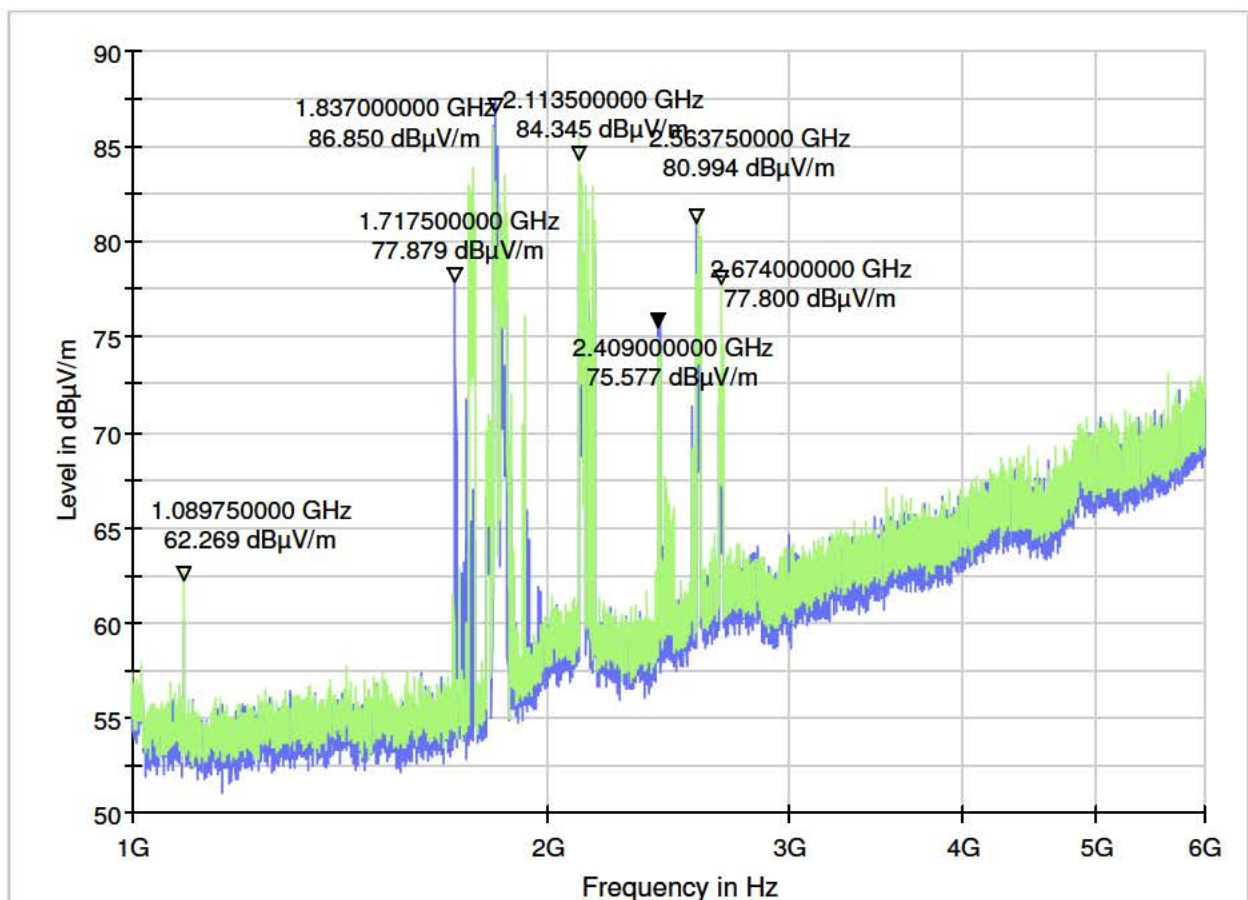

PK+_MAXH PK+_MAXH(1)@Ambient @1G-6G HOR@3m-PK 11-04

Measurement graphic (P-3, Vertical):

Subrange	Step Size	Detectors	Bandwidth	Sweep Time	Preamp
1 GHz - 6 GHz	250 kHz	PK+	1 MHz	Coupled	20 dB

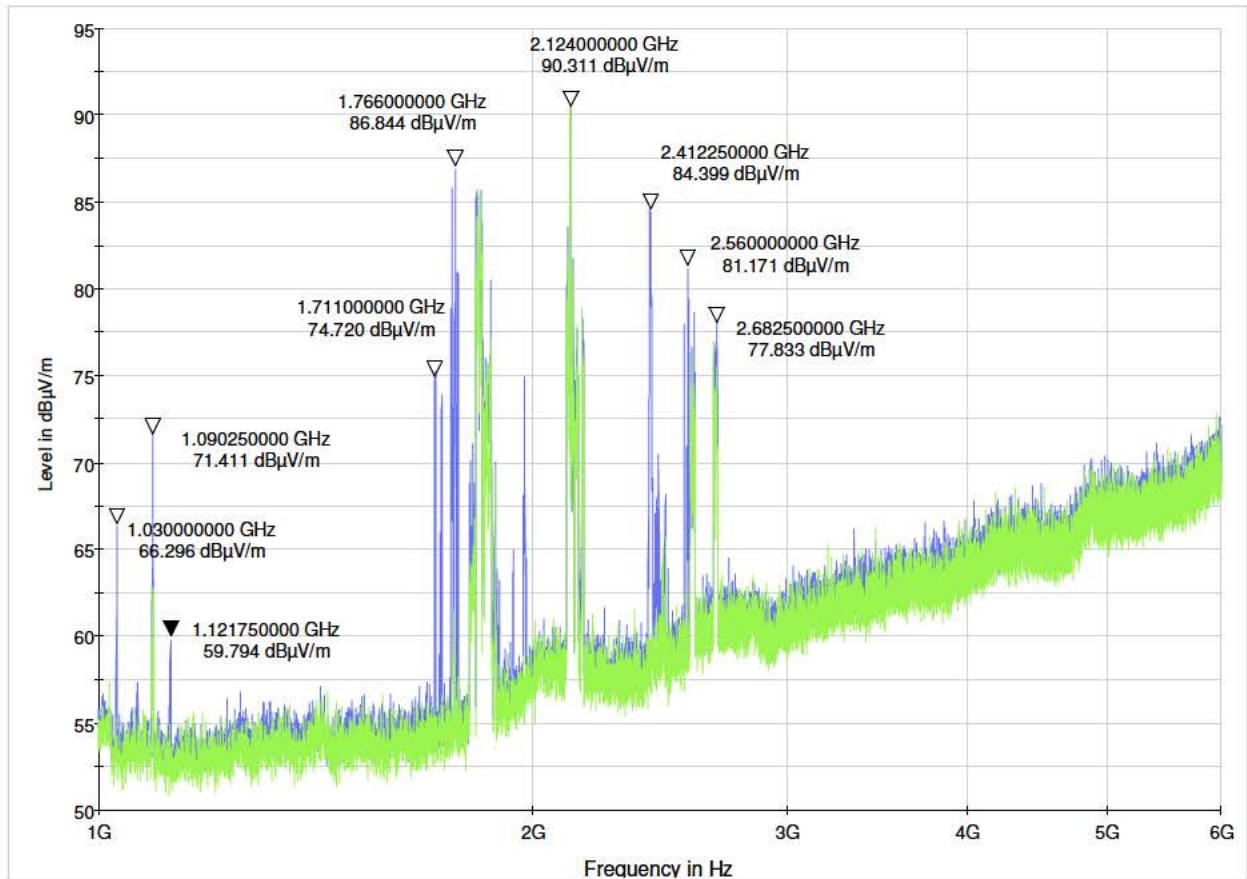

PK+_MAXH PK+_MAXH(1)@Ambient @1G-6G VER@3m-PK 11-39

Frequency range [GHz]	Date & Time	Direction	Operating condition / Train type	Train serial #		Estimated current during test [A]		Distance to track [m]	Height - antenna [m]	Remark
				1	2	Min	Max			
1 - 6	2018/11/26 11:15	O => W	Braking train@track SP2ADC	---	---	---	---	3	2	P-3 / HOR
1 - 6	2018/11/26 11:56	O => W		---	---	---	---	3	2	P-3 / VER

Measurement graphic (P-3, Horizontal):

Subrange 1 GHz - 6 GHz Step Size 250 kHz Detectors PK+ Bandwidth 1 MHz Sweep Time Coupled Preamp 20 dB

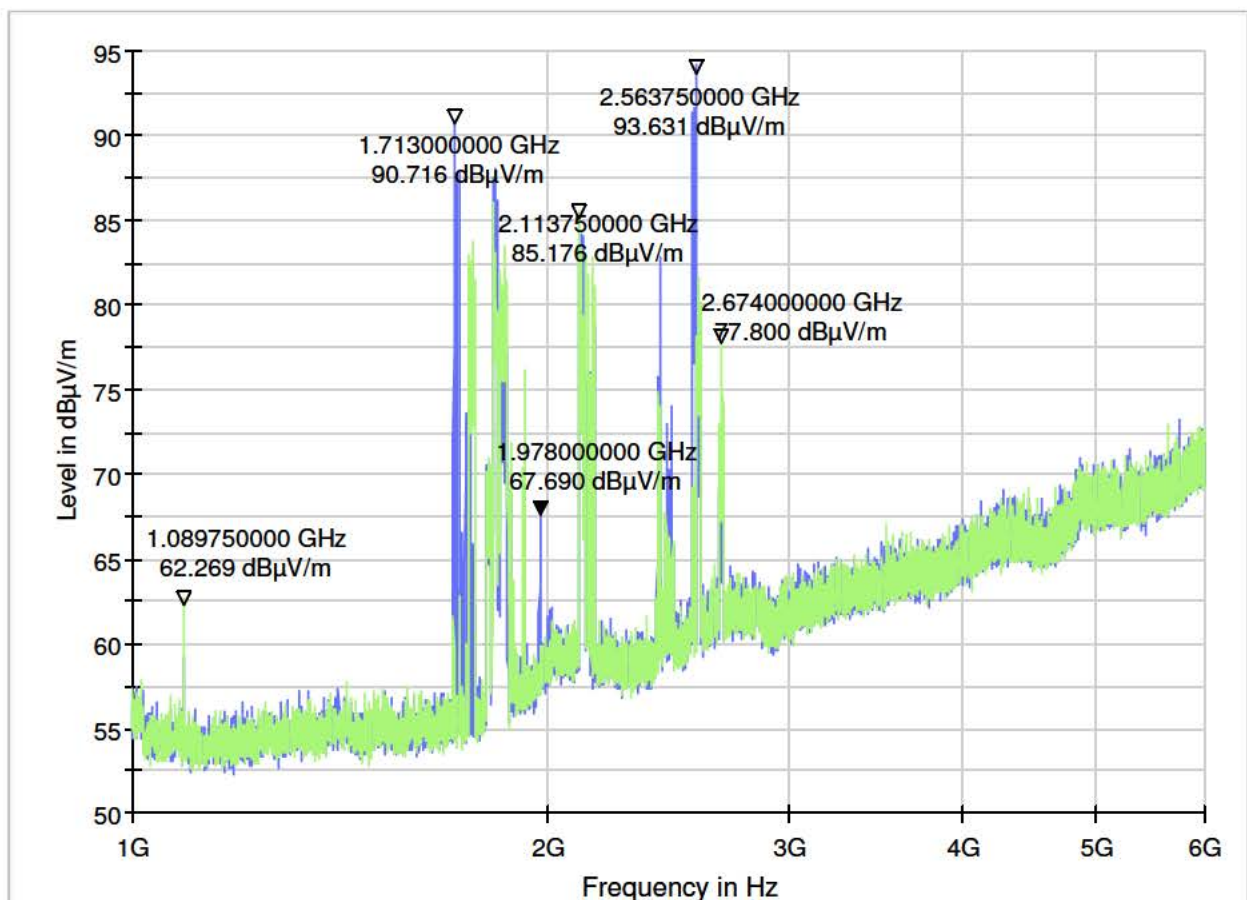

PK+_MAXH PK+_MAXH(1)@Ambient @1G-6G HOR@3m-PK 11-04

Measurement graphic (P-3, Vertical):

Subrange	Step Size	Detectors	Bandwidth	Sweep Time	Preamp
1 GHz - 6 GHz	250 kHz	PK+	1 MHz	Coupled	20 dB

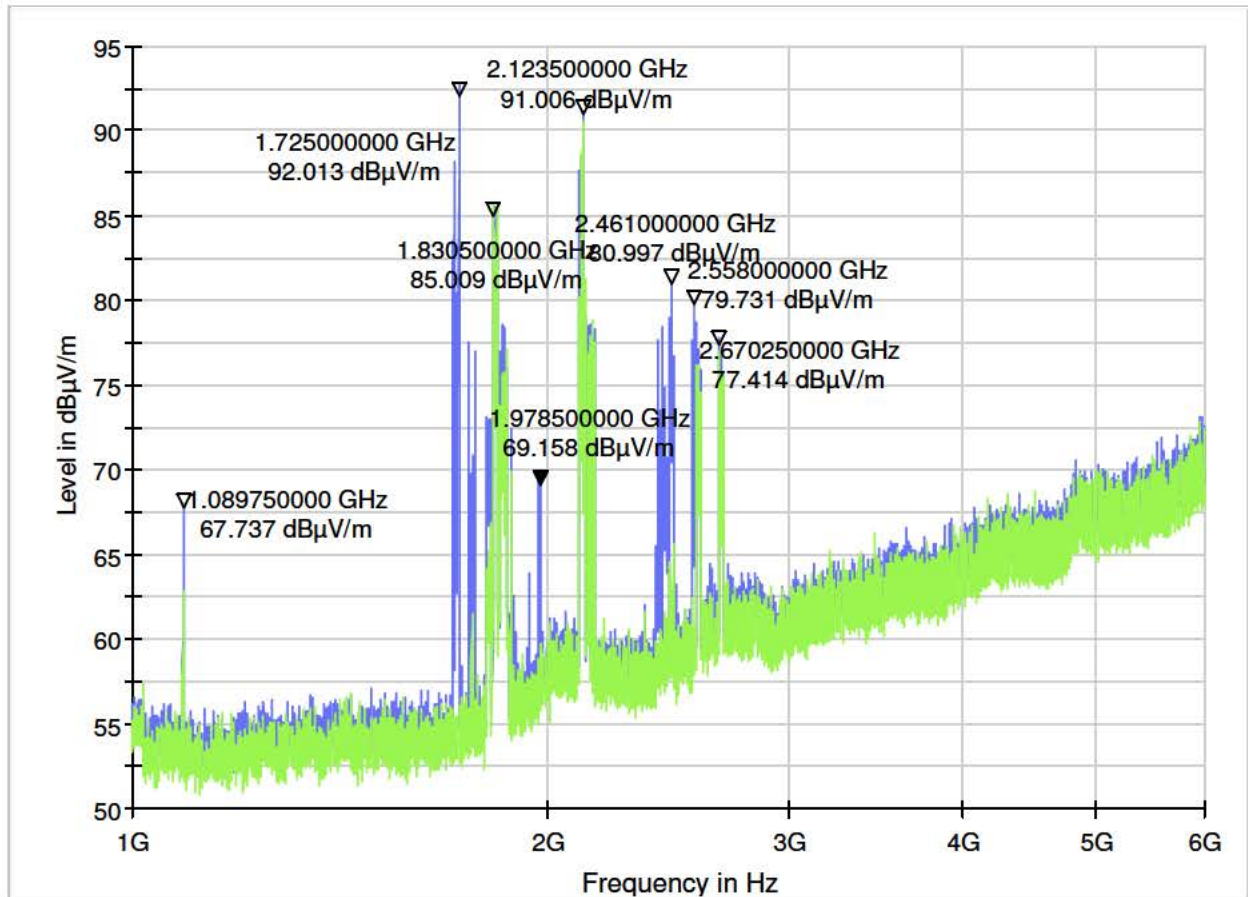

— PK+_MAXH — PK+_MAXH(1)@Ambient @1G-6G VER@3m-PK 11-39

A4.2 Stoptrain (acceleration)/ Transit / Braking, h=2.5 m., d=10 m. (1 - 6 GHz)

Frequency range [GHz]	Date & Time	Direction	Operating condition / Train type	Train serial #		Estimated current during test [A]		Distance to track [m]	Height - antenna [m]	Remark
				1	2	Min	Max			
1 - 6	2018/11/26 10:47	W => O	Stoptrain / Flirt	2501	2219	-200	1100	10	2.5	P-5 / HOR
1 - 6	2018/11/26 10:18	W => O	Stoptrain / Flirt	2228	2507	-500	1200	10	2.5	P-5 / VER

Subrange 1 GHz - 6 GHz Step Size 250 kHz Detectors PK+ Bandwidth 1 MHz Sweep Time Coupled Preamp 20 dB

Measurement graphic (P-5, Horizontal):

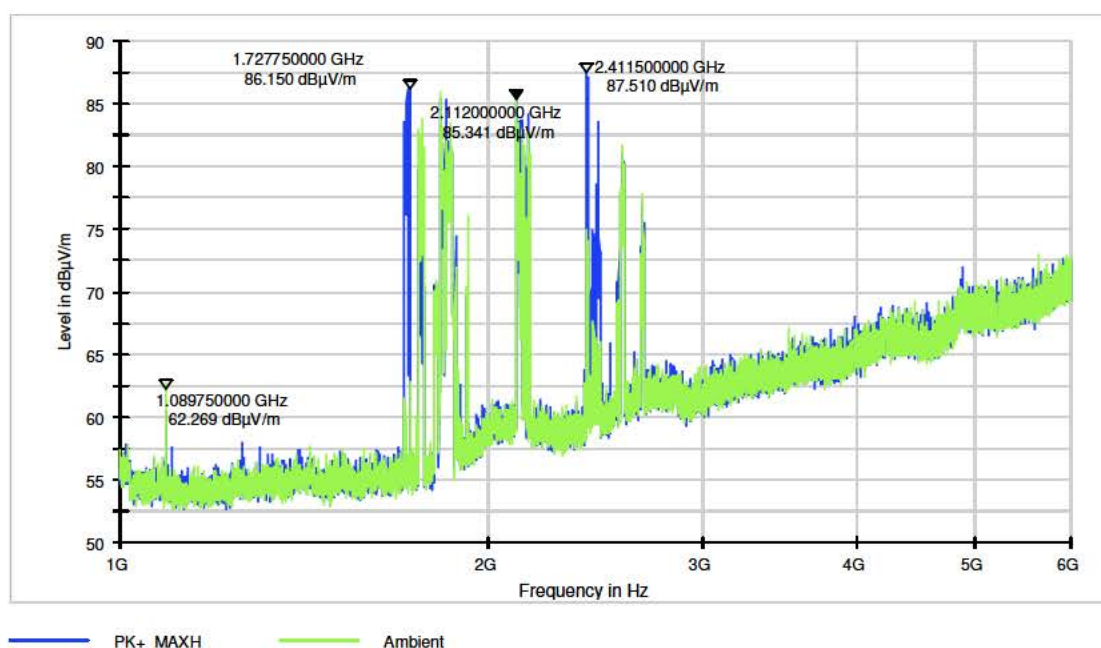

Measurement graphic (P-5, Vertical):

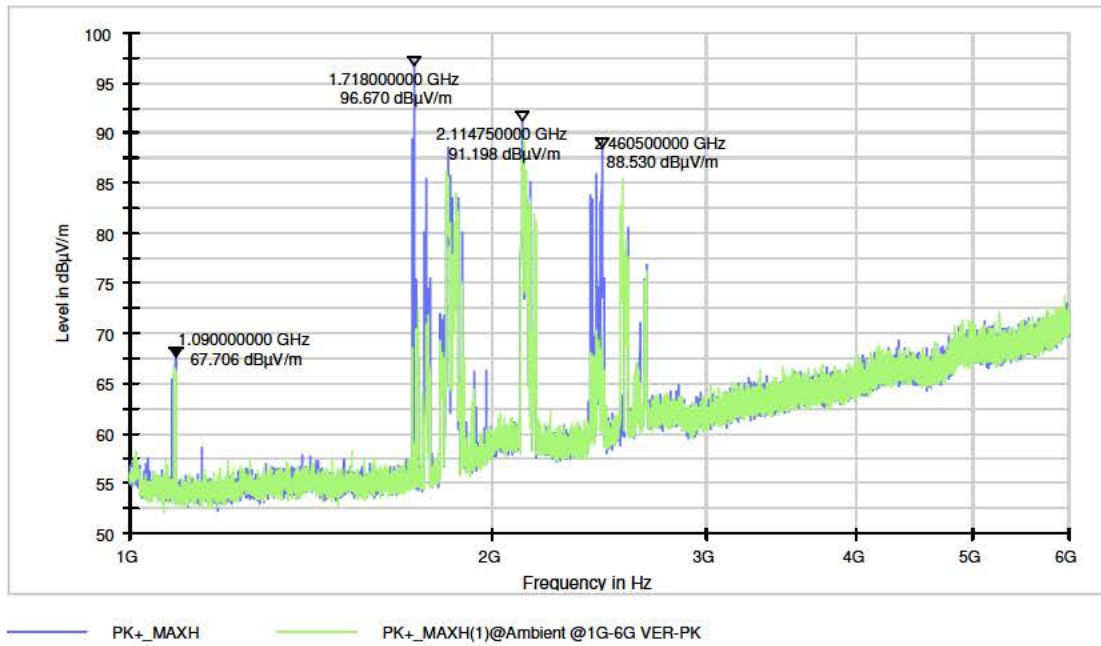

Frequency range [GHz]	Date & Time	Direction	Operating condition / Train type	Train serial #		Estimated current during test [A]		Distance to track [m]	Height - antenna [m]	Remark
				1	2	Min	Max			
1 - 6	2018/11/26 10:34	W => O	Transit / DDZ	7608	---	-275	40	10	2.5	P-5 / HOR
1 - 6	2018/11/26 10:05	W => O	Transit / ICM	4063	4047	-250	120	10	2.5	P-5 / VER

Subrange 1 GHz - 6 GHz Step Size 250 kHz Detectors PK+ Bandwidth 1 MHz Sweep Time Coupled Preamp 20 dB

Measurement graphic (P-5, Horizontal):

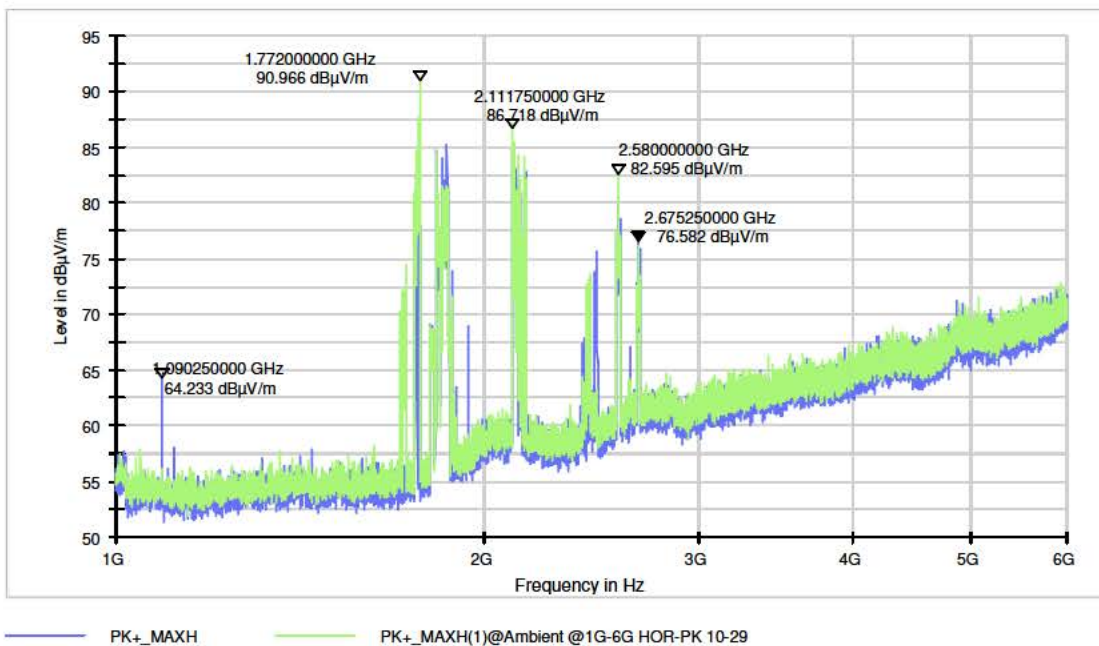

Measurement graphic (P-5, Vertical):

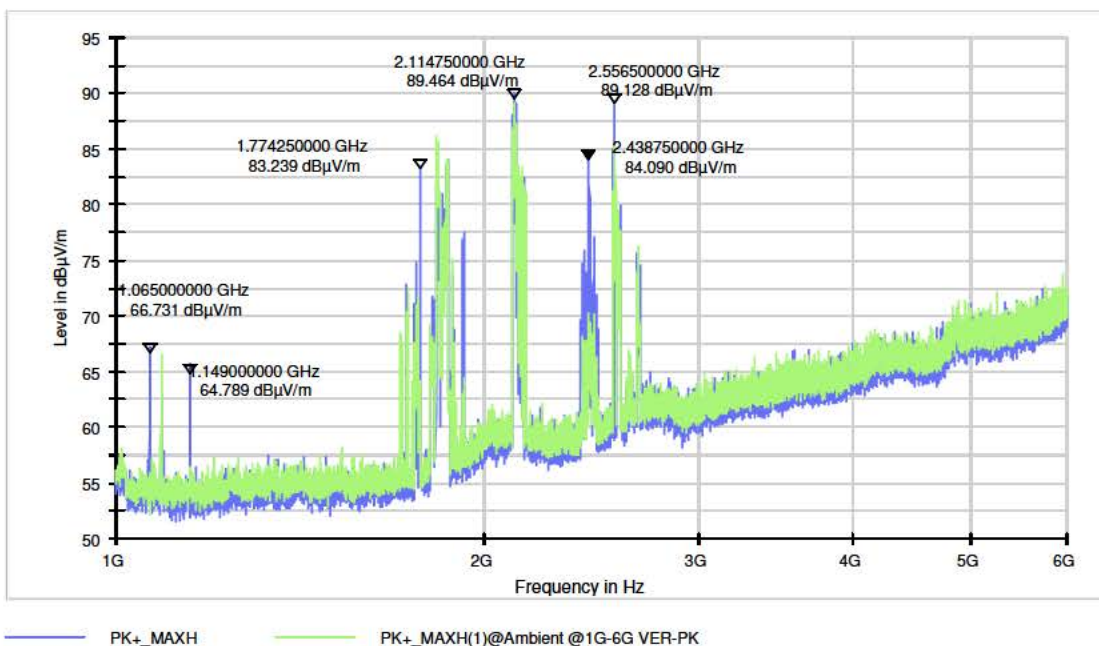

A4.3 Stoptrain (acceleration)/ Transit / Braking, h=2.5 m., d=30 m. (1 - 6 GHz)

Frequency range [GHz]	Date & Time	Direction	Operating condition / Train type	Train serial #		Estimated current during test [A]		Distance to track [m]	Height - antenna [m]	Remark
				1	2	Min	Max			
1 - 6	2018/11/26 13:47	W => O	Stoptrain / Flirt	2209	---	-570	260	30	2.5	P-6 / HOR
1 - 6	2018/11/26 13:17	W => O	Stoptrain / Flirt	2216	---	-600	250	30	2.5	P-6 / VER

Subrange 1 GHz - 6 GHz Step Size 250 kHz Detectors PK+ Bandwidth 1 MHz Sweep Time Coupled Preamp 20 dB

Measurement graphic (P-6, Horizontal):

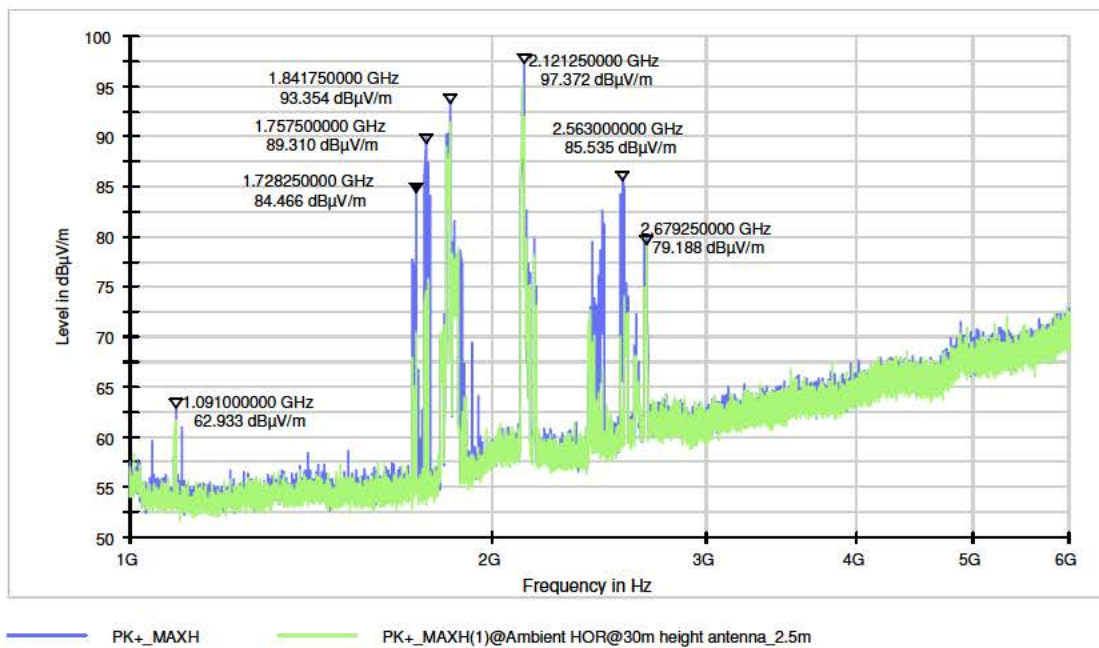

Measurement graphic (P-6, Vertical):

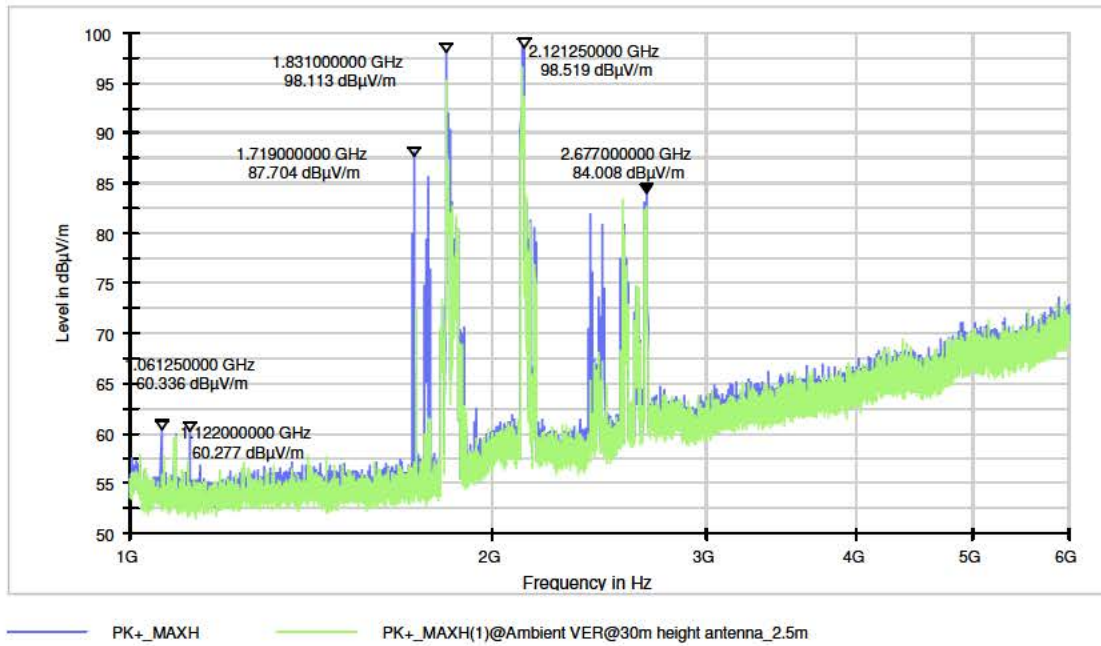

Frequency range [GHz]	Date & Time	Direction	Operating condition / Train type	Train serial #		Estimated current during test [A]		Distance to track [m]	Height - antenna [m]	Remark
				1	2	Min	Max			
1 - 6	2018/11/26 14:03	W => O	Transit / DDZ	7614	---	-120	-10	30	2.5	P-6 / HOR
1 - 6	2018/11/26 13:34	W => O	Transit / DDZ	7616	---	-300	100	30	2.5	P-6 / VER

Subrange 1 GHz - 6 GHz Step Size 250 kHz Detectors PK+ Bandwidth 1 MHz Sweep Time Coupled Preamp 20 dB

Measurement graphic (P-6, Horizontal):

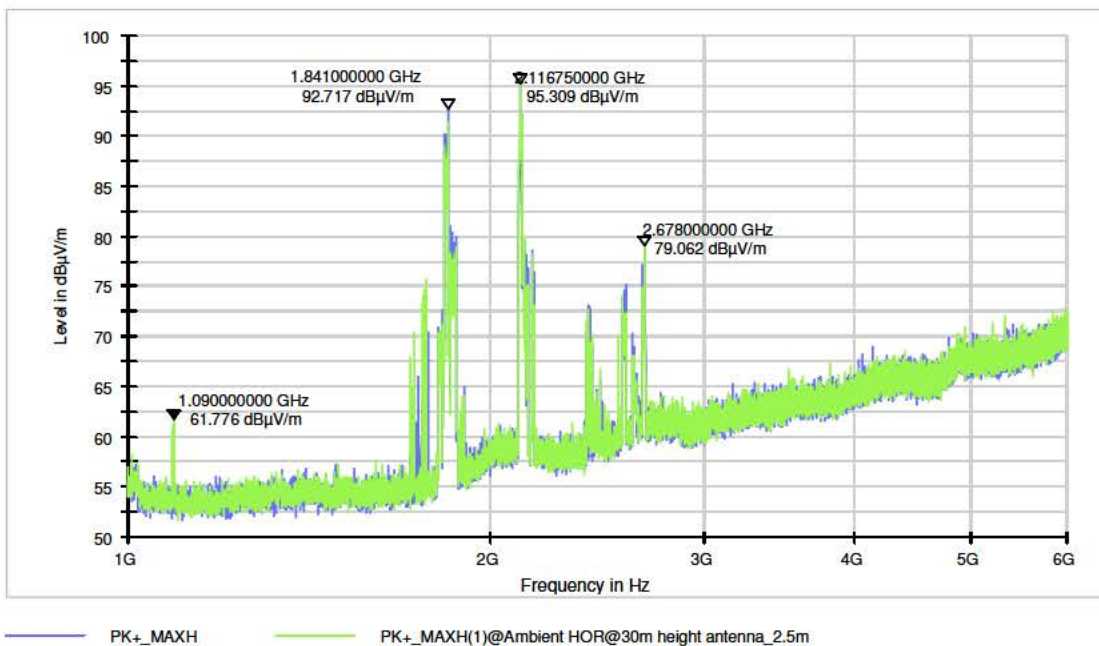

Measurement graphic (P-6, Vertical):

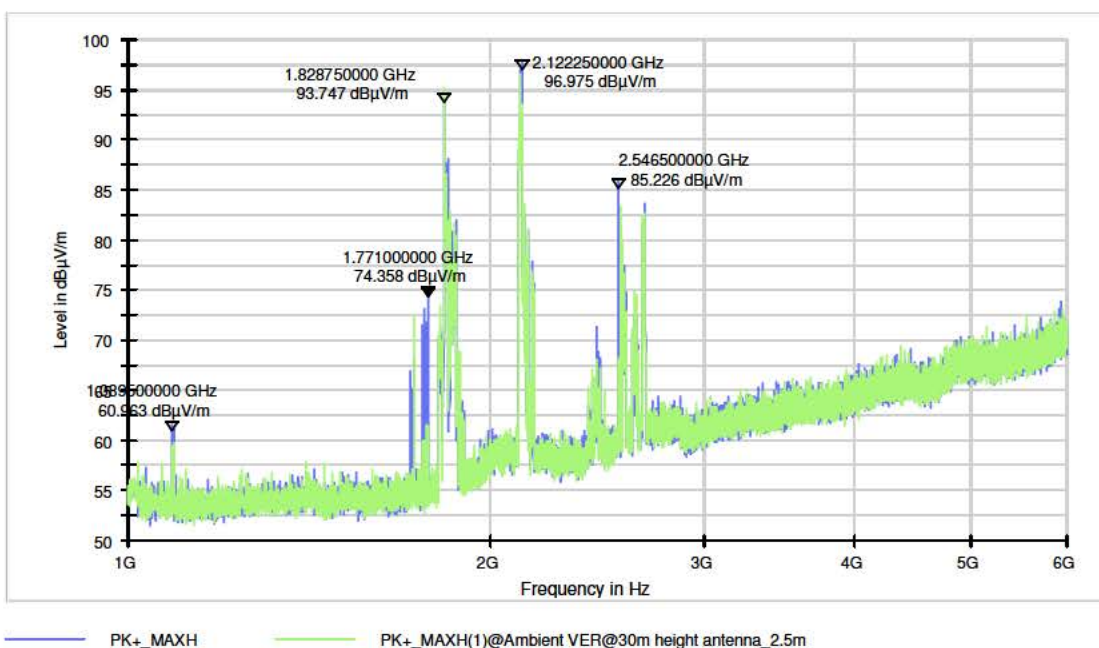

A4.4 Stoptrain (acceleration)/ Transit / Braking, Barrier and surrounding, h=2.5 m., d=30 m. (1 - 6 GHz)

The measurements given below have been obtained by doing long-term measurements using “max-hold” function of the spectrum analyzer equipment. The measurements have been done when the antenna has been positioned to “East”, “South” and “West” direction respectively. The purpose of these measurements was to identify the RF fields from the surrounding of the Railway Crossing.

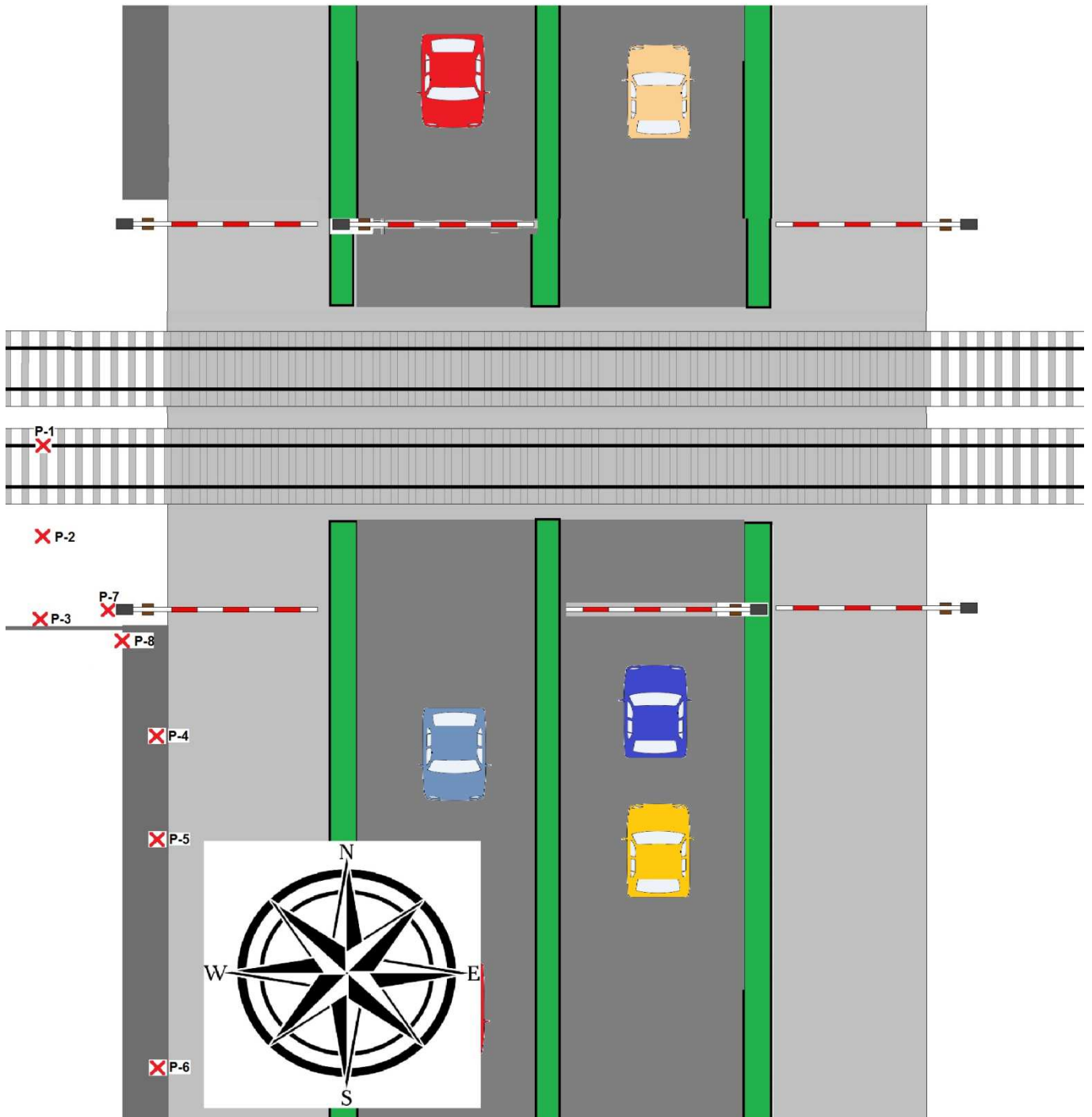

Measurement graphic (P-6, East-direction, Horizontal):

Subrange	Step Size	Detectors	Bandwidth	Sweep Time	Preamp
1 GHz - 6 GHz	250 kHz	PK+	1 MHz	Coupled	20 dB

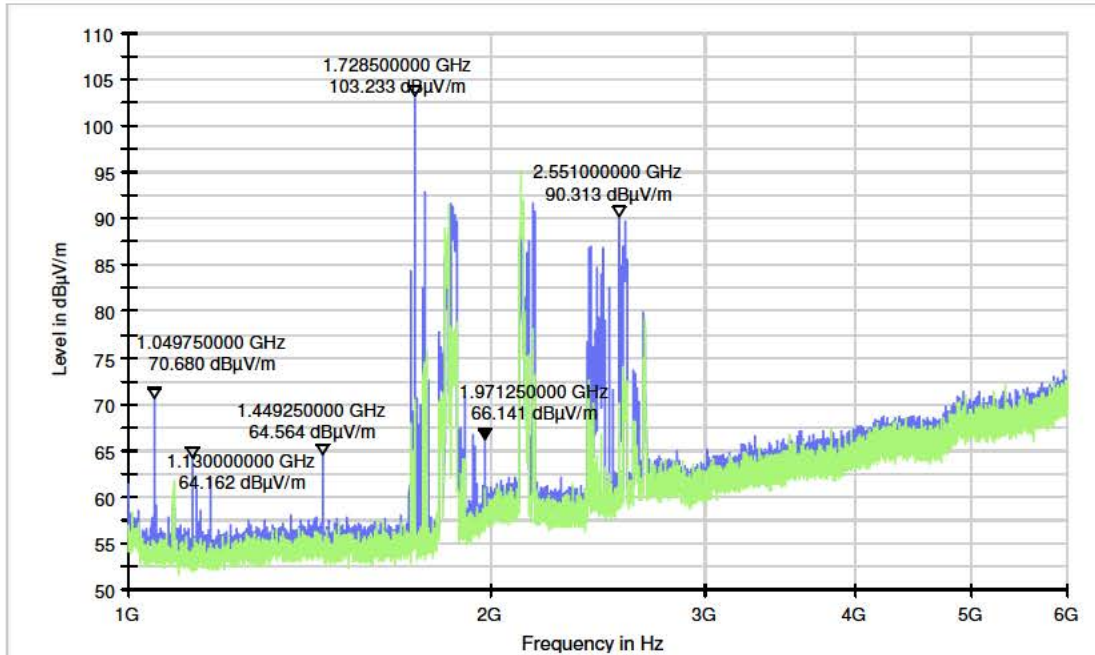

PK+_MAXH PK+_MAXH(1)@Ambient HOR@30m height antenna_2.5m

Measurement graphic (P-6, East-direction, Vertical):

Subrange	Step Size	Detectors	Bandwidth	Sweep Time	Preamp
1 GHz - 6 GHz	250 kHz	PK+	1 MHz	Coupled	20 dB

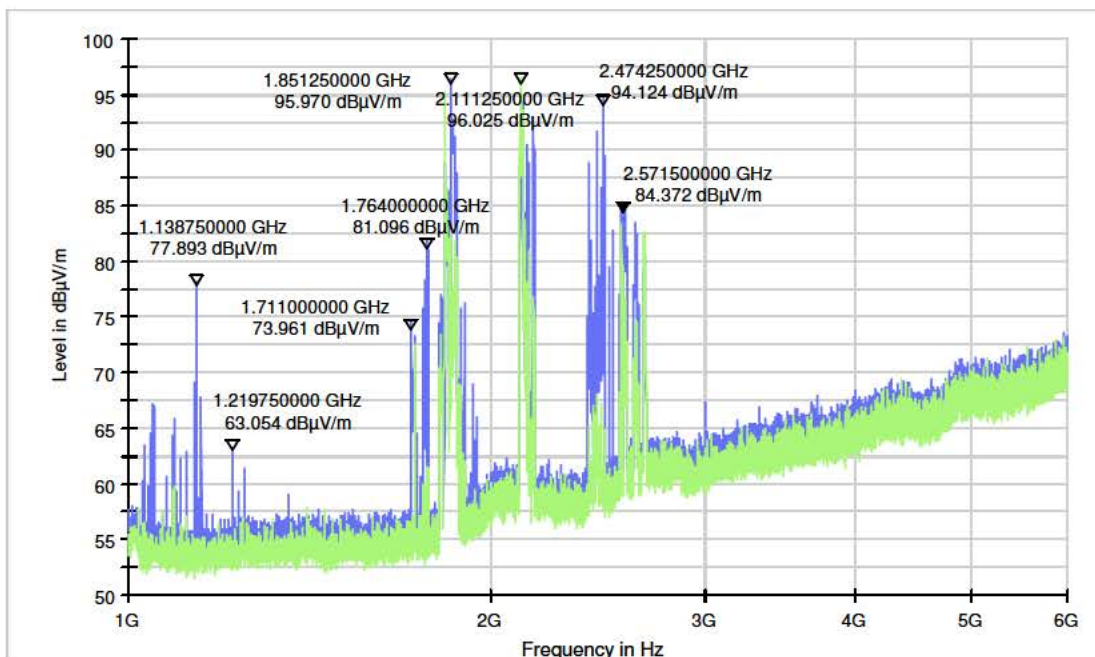

PK+_MAXH PK+_MAXH(1)@Ambient VER@30m height antenna_2.5m

Measurement graphic (P-6, South-direction, Horizontal):

Subrange	Step Size	Detectors	Bandwidth	Sweep Time	Preamp
1 GHz - 6 GHz	250 kHz	PK+	1 MHz	Coupled	20 dB

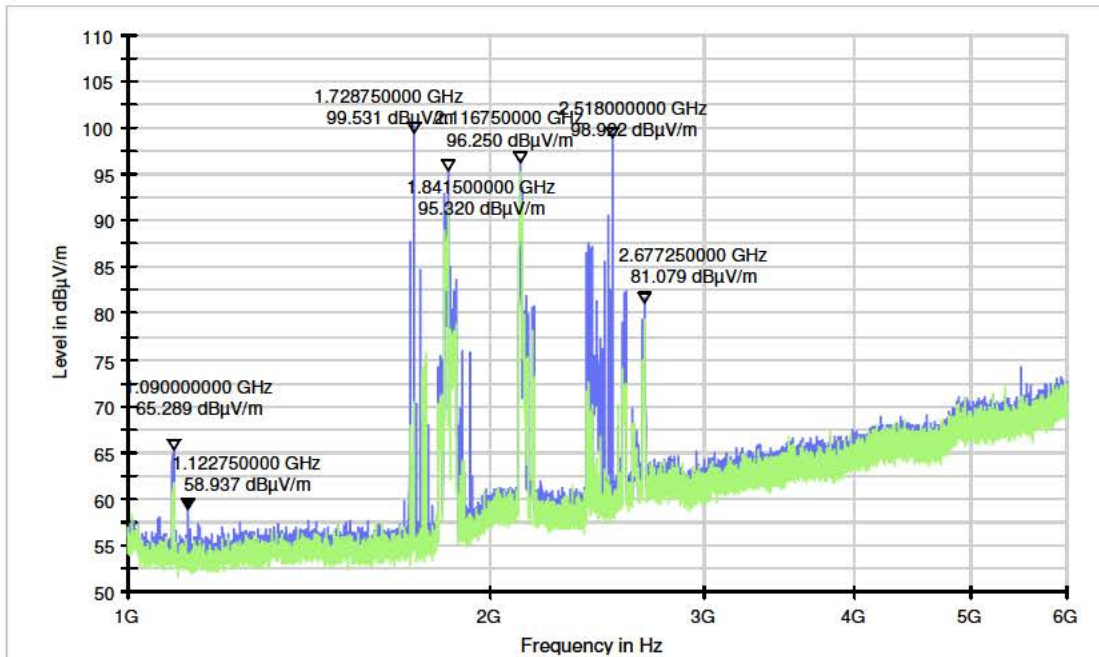

PK+_MAXH PK+_MAXH(1)@Ambient HOR@30m height antenna_2.5m

Measurement graphic (P-6, South-direction, Vertical):

Subrange	Step Size	Detectors	Bandwidth	Sweep Time	Preamp
1 GHz - 6 GHz	250 kHz	PK+	1 MHz	Coupled	20 dB

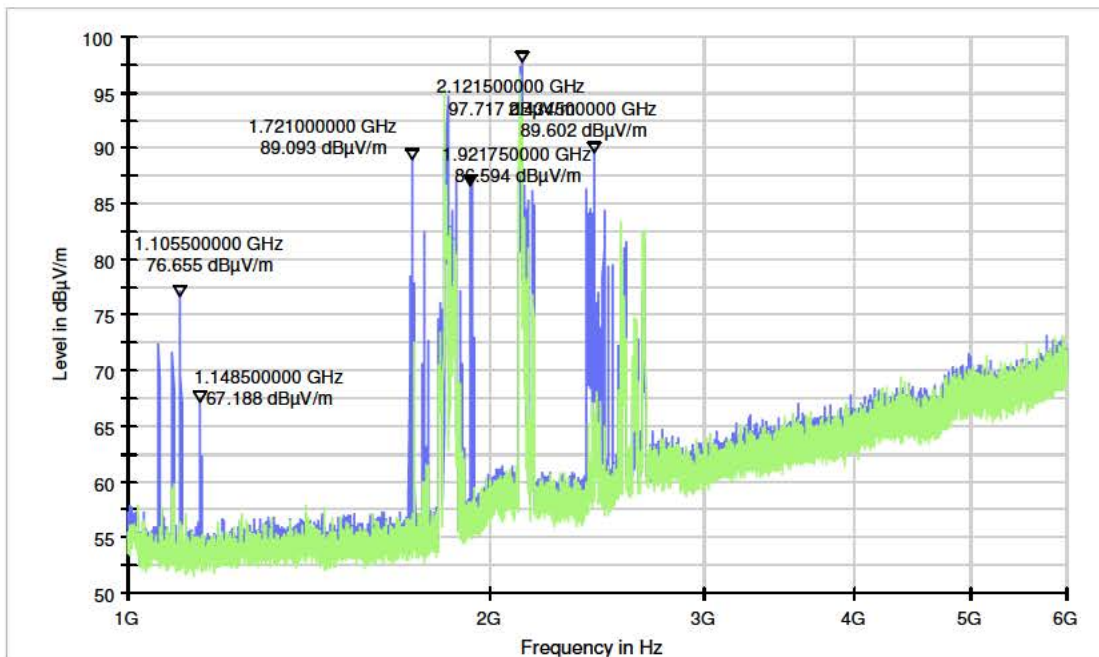

PK+_MAXH PK+_MAXH(1)@Ambient VER@30m height antenna_2.5m

Measurement graphic (P-6, West-direction, Horizontal):

Subrange	Step Size	Detectors	Bandwidth	Sweep Time	Preamp
1 GHz - 6 GHz	250 kHz	PK+	1 MHz	Coupled	20 dB

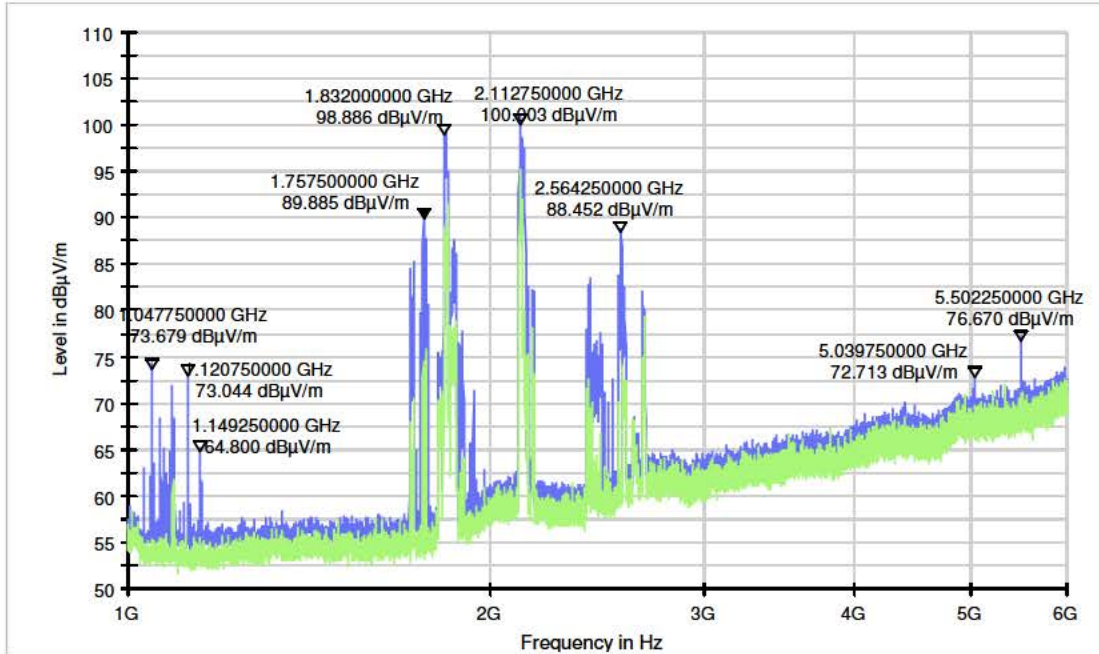

PK+_MAXH PK+_MAXH(1)@Ambient HOR@30m height antenna_2.5m

Measurement graphic (P-6, West-direction, Vertical):

Subrange	Step Size	Detectors	Bandwidth	Sweep Time	Preamp
1 GHz - 6 GHz	250 kHz	PK+	1 MHz	Coupled	20 dB

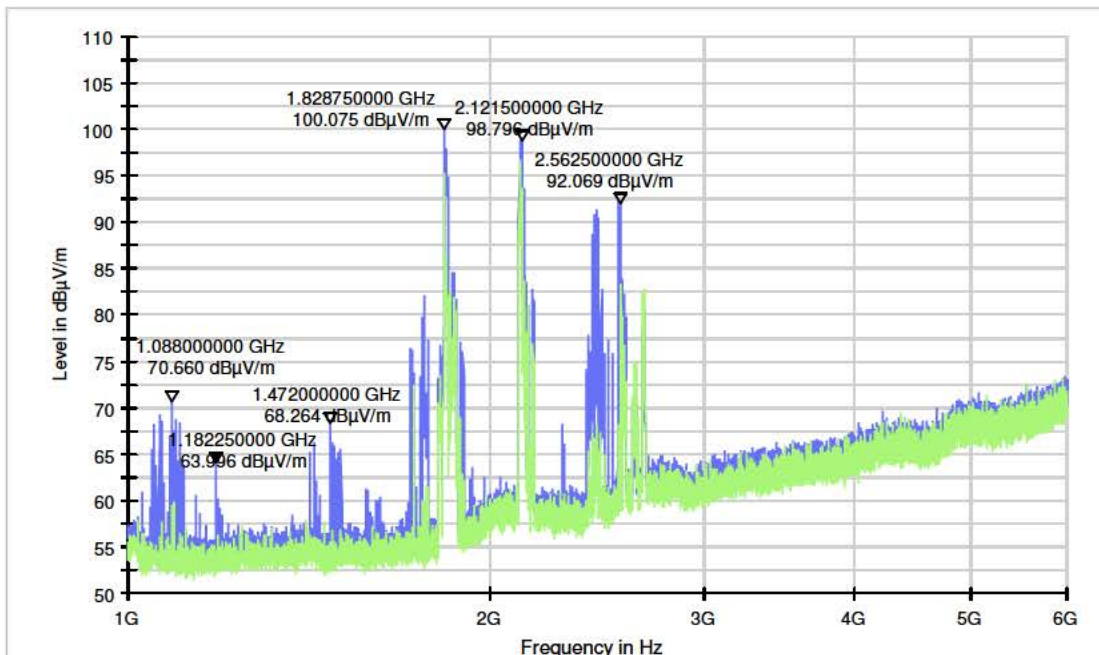

PK+_MAXH PK+_MAXH(1)@Ambient VER@30m height antenna_2.5m

Annex 5: Test Photos

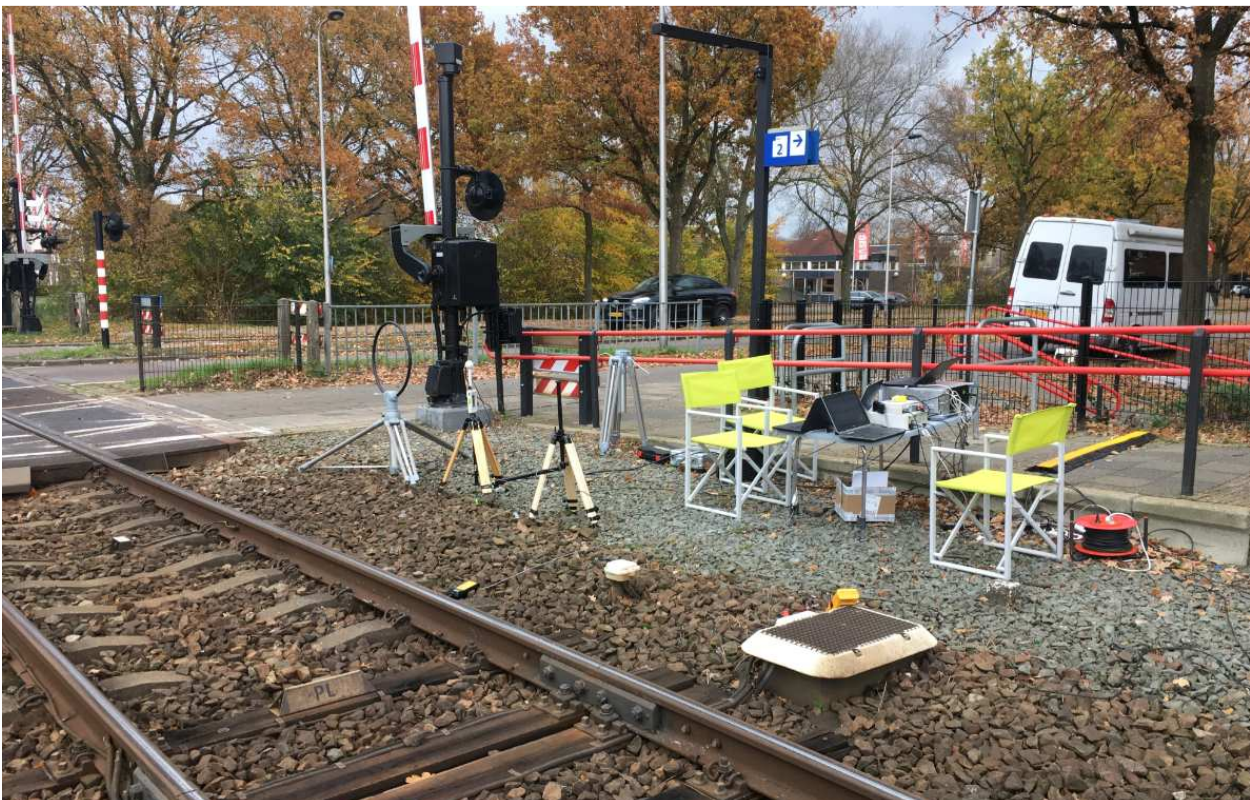















ANNEX 6 - MEASUREMENT UNCERTAINTIES

The table(s) below show(s) measurement uncertainties of the EMC test set-ups. The reported expanded uncertainties are based on a standard uncertainty multiplied by a coverage factor of $k=2$, providing a level of confidence of approximately 95%.

Test	Uncertainty
Radiated magnetic field emissions; 9 kHz – 30 MHz (triple loop)	2,90 dB
Radiated emissions; 30 MHz – 1000 MHz (Horz.)	3,71 dB
Radiated emissions; 30 MHz – 1000 MHz (Vert.)	4,74 dB
Radiated emissions; 1000 MHz – 6000 MHz (Horz.)	4,90 dB
Radiated emissions; 1000 MHz – 6000 MHz (Vert.)	4,90 dB
Radiated magnetic field emissions; 9 kHz – 30 MHz	2,90 dB
Magnetic flux density at frequency range 5 Hz – 400 KHz (3D H/E fieldmeter)	5%
Electric field strength at frequency range 5 Hz – 400 KHz (3D H/E fieldmeter)	5%
Static magnetic flux density, DC, up 200 μ T (Mag-01H)	5%
Static magnetic flux density, DC, 0.1 – 20 mT (ETM-1)	8%

ANNEX 7 – TRAIN DATA

The following tables show the trains which have stopped / passed during the measurement period. Also there were some other trains which are not listed below but stopped/passed by the station.

Metingen Oss West, 19-11-2018

Weersomstandigheden: Droog, koud (ca. 5°C)

Nr.	Time	Direction	Train type	Train serial number		Speed [km/h]	Estimated current during test [A]		Remarks
				1	2		Min	Max	
0	09:17	W => O	Stoptrein Flirt	2219	2504	N.v.t. (aanzet vanaf stilstand)		800	
1	09:28	O => W	IC ICM	4049	4224			800	
2	09:35	W => O	IC DDZ	7620	---			40	
3	09:47	W => O	Stoptrein Flirt	2209	2510	N.v.t. (aanzet vanaf stilstand)		500	
4	09:50	O => W	IC VIRM	9548	---				
5	10:05	W => O	IC ICM	4060	4247		-300	140	
6	10:15	O => W	Stoptrein Flirt	2212	2511	N.v.t. (aanzet vanaf stilstand)			
7	10:19	W => O	Stoptrein Flirt	2232	2512	N.v.t. (aanzet vanaf stilstand)	-600	300	
8	10:29	-	---	---	---	---	---	---	referentie, current clamps not in track,
9	10:36	W => O	IC DDZ	7637	---		0	90	
10	10:46	O => W	Stoptrein Flirt	2517	2228	N.v.t. (aanzet vanaf stilstand)		550	
11	10:47	W => O	Stoptrein Flirt	2224	---	N.v.t. (aanzet vanaf stilstand)			
12	10:57	O => W	IC DDZ	7614	---			96	
13	11:04	W => O	IC DDZ	7612	---		-200	130	
14	11:15	O => W	Stoptrein Flirt	2504	2219	N.v.t. (aanzet vanaf stilstand)			
15	11:17	W => O	Stoptrein Flirt	2508	2223	N.v.t. (aanzet vanaf stilstand)	-900	700	
16	11:35	W => O	IC VIRM	9xxx	---				overbrengingsrit?
17	11:38	W => O	IC DDZ	7636	---		-200	100	
18	11:51	W => O	Stoptrein Flirt	2221	2227	N.v.t. (aanzet vanaf stilstand)	-50	1350	
19	12:04	W => O	IC ICM	4224	---		-100	40	
20	12:21	W => O	Stoptrein Flirt	2507	2211	N.v.t. (aanzet vanaf stilstand)	-110	650	

21	12:52	W => O	IC VIRM	9548	---		-200	340	
22	13:05	W => O	IC DDZ	7608	---		-280	-40	
23	13:21	W => O	Stoptrein Flirt	2212	---	N.v.t. (aanzet vanaf stilstand)	-50	420	
24	13:37	W => O	IC DDZ	7614	---		-650	-90	
25	13:50	W => O	Stoptrein Flirt	2524	2228	N.v.t. (aanzet vanaf stilstand)	-50	300	
26	14:03	W => O	IC DDZ	7632	---		-200	-40	
0	14:20	W => O	Stoptrein Flirt	2219	2504	N.v.t. (aanzet vanaf stilstand)	-960	100	
27	14:35	W => O	IC DDZ	7650	---		-100	200	
28	14:48	W => O	Stoptrein Flirt	2209	2510	N.v.t. (aanzet vanaf stilstand)	-400	1100	
29	14:55	-	---	---	---	---	---	---	referentie, current clamps not in track,
30	15:04	W => O	IC DDZ	7618	---		-160	30	
31	15:19	W => O	Stoptrein Flirt	2232	2512	N.v.t. (aanzet vanaf stilstand)	-40	1240	
32	15:33	W => O	IC DDZ	7620	---		-225	-60	
33	15:47	W => O	Stoptrein Flirt	2224	2203	N.v.t. (aanzet vanaf stilstand)	-515	600	
34	15:54	W => O	Stoptrein Flirt	22xx	22xx	N.v.t. (aanzet vanaf stilstand)	-475	-200	
35	16:04	W => O	IC ICM	4060	4247		-90	-15	
36	16:19	W => O	Stoptrein Flirt	2508	2223	N.v.t. (aanzet vanaf stilstand)	-480	350	
37	16:27	W => O	Stoptrein Flirt	3523	2513	N.v.t. (aanzet vanaf stilstand)	-250	130	

Metingen Oss West, 20-11-2018

Weersomstandigheden: Droog, koud (ca. 4-6°C)

Nr.	Time	Direction	Train type	Train serial number		Speed [km/h]	Estimated current during test [A]		Remarks
				1	2		Min	Max	
1	08:57	W => O	Stoptrein Flirt	2223	2524	N.v.t. (aanzet vanaf stilstand)	-200	1150	
2	09:04	W => O	IC DDZ	7618		130	-250	-150	
3	09:18	W => O	Stoptrein Flirt	2213	2512	N.v.t. (aanzet vanaf stilstand)	-900	750	
4	09:33	W => O	IC DDZ	7649	---	130	-350	-20	
5	09:49	W => O	Stoptrein Flirt	2219	2504	N.v.t. (aanzet vanaf stilstand)	-450	950	
6	10:04	W => O	IC ICM	4030	---	100	-100	0	
7	10:18	W => O	Stoptrein Flirt	2510	2209	N.v.t. (aanzet vanaf stilstand)	-325	850	
8	10:34	W => O	IC DDZ	7635	---	125	-50	60	
9	10:48	W => O	Stoptrein Flirt	2224	2212	N.v.t. (aanzet vanaf stilstand)	-660	820	
10	11:05	W => O	IC DDZ	7616	---		-150	-150	
11	11:18	W => O	Stoptrein Flirt	2517	2215	N.v.t. (aanzet vanaf stilstand)	-1000	430	
12	11:35	W => O	IC DDZ	7620	---		-200	300	
13	11:50	W => O	Stoptrein Flirt	2227	2525	N.v.t. (aanzet vanaf stilstand)	-550	780	
14	12:04	W => O	IC ICM	4247	---		-20	0	
15	12:34	W => O	IC DDZ	7534	---		-150	0	
16	12:39	-	---	---	---				nulmeting
17	12:48	W => O	Stoptrein Flirt	2507	2211	N.v.t. (aanzet vanaf stilstand)	-150	450	
18	13:04	W => O	IC DDZ	7650	---	120	-175	50	
19	13:19	W => O	Stoptrein Flirt	2208	---	N.v.t. (aanzet vanaf stilstand)	-150	340	
20	13:34	W => O	IC DDZ	7632	---	130	-225	60	
21	13:48	W => O	Stoptrein Flirt	2524	---	N.v.t. (aanzet vanaf stilstand)	-250	300	
22	14:04	W => O	IC DDZ	7614	---	130	-180	50	
23	14:18	W => O	Stoptrein Flirt	2232	2512	N.v.t. (aanzet vanaf stilstand)	-420	825	
24	14:34	W => O	IC DDZ	7608	---	130	-180	50	
25	14:48	W => O	Stoptrein Flirt	2219	2504	N.v.t. (aanzet vanaf stilstand)	-600	650	
26	15:04	W => O	IC DDZ	7618	---		-300	90	
0	15:18	W => O	Stoptrein Flirt	2209	2510	N.v.t. (aanzet vanaf stilstand)	-450	520	

27	15:27	O=>W	IC ICM	4xxx	4xxx				anderspoor meting ivm spikes op stroom
28	15:35	W => O	IC DDZ	7649	---		-240	80	
29	15:48	W => O	Stoptrein Flirt	2212	2224	N.v.t. (aanzet vanaf stilstand)	-125	750	
30	15:52	W => O	IC Flirt	2521	2515	110	-25	350	
31	16:04	W => O	IC ICM	4060	4028	130	-250	-25	
32	16:18	W => O	Stoptrein Flirt	2517	2215	N.v.t. (aanzet vanaf stilstand)	-200	750	
33	16:29	W => O	Stoptrein Flirt	2511	2502	N.v.t. (aanzet vanaf stilstand)	-200	150	
34	16:34	W => O	IC DDZ	7635	---		-350	0	

Metingen Oss West, 21-11-2018

Weersomstandigheden: Droog, koud (ca. 4-6°C)

Nr.	Time	Direction	Train type	Train serial number		Speed [km/h]	Estimated current during test		Remarks
				1	2		Min	Max	
0	08:51	W=>O	N.v.t	---	---	---	---	---	Referentiemeting stroomtangen
1	09:17	W=>O	Stoptrein Flirt	2222	2525	N.v.t. (aanzet vanaf stilstand)	-450	1200	
2	09:35	W=>O	IC DDZ	7637	---	---	-200	-30	
3	09:47	W=>O	Stoptrein Flirt	2232	2512	N.v.t. (aanzet vanaf stilstand)	-550	1040	
4	10:04	W=>O	IC ICM	4247	4028	---	-70	-5	
5	10:19	W=>O	Stoptrein Flirt	2219	2504	N.v.t. (aanzet vanaf stilstand)	-510	890	
6	10:34	W=>O	IC DDZ	7635	---	---	-199	30	
7	10:49	W=>O	Stoptrein Flirt	2506	2208	N.v.t. (aanzet vanaf stilstand)	-200	1370	
8	11:05	W=>O	IC DDZ	7609	---	131	-160	100	
9	11:17	W=>O	Stoptrein Flirt	2508	2215	N.v.t. (aanzet vanaf stilstand)	-900	750	
10	11:34	W=>O	IC DDZ	7649	---	132	-290	-50	
11	11:36	W=>O	DDM	1732	---	Schatting: 60km/h	-100	60	Niet zichtbaar op Treinposities.nl
12	11:48	W=>O	Stoptrein Flirt	2507	2224	N.v.t. (aanzet vanaf stilstand)	-200	550	
13	12:04	W=>O	IC ICM	4048	---	120	-90	15	
14	12:18	W=>O	Stoptrein Flirt	2510	---	N.v.t. (aanzet vanaf stilstand)	-710	310	
15	12:34	W=>O	IC VIRM	9556	---	117	-270	-79	
16	12:48	W=>O	Stoptrein Flirt	2522	2207	N.v.t. (aanzet vanaf stilstand)	-600	730	
17	13:04	W=>O	IC DDZ	7616	---	121	-250	15	
18	13:18	W=>O	Stoptrein Flirt	2210	---	N.v.t. (aanzet vanaf stilstand)	-100	310	
19	13:35	W=>O	IC DDZ	7614	---	123	-189	-50	
20	13:48	W=>O	Stoptrein Flirt	2231	---	N.v.t. (aanzet vanaf stilstand)	-635	250	
21	14:04	W=>O	IC DDZ	7632	---	122	-20	-187	
22	14:17	W=>O	Stoptrein Flirt	2525	2222	N.v.t. (aanzet vanaf stilstand)	-480	805	
23	14:34	W=>O	IC DDZ	7534	---	132	-260	-15	

24	14:48	W=>O	Stoptrein Flirt	2512	2229	N.v.t. (aanzet vanaf stilstand)	-650	1011	
25	15:04	W=>O	IC DDZ	7608	---	124	-222	75	
26	15:17	W=>O	Stoptrein Flirt	2504	2219	N.v.t. (aanzet vanaf stilstand)	-500	1224	
0	15:22	W=>O	N.v.t	---	---	---	---	---	Referentiemeting stroomtangen ()
27	15:34	W=>O	IC DDZ	7637	---	140	-232	-12	
28	15:48	W=>O	Stoptrein Flirt	2506	2208	N.v.t. (aanzet vanaf stilstand)	-520	1265	
29	15:51	W=>O	Doorgaande Flirt	25xx	22xx	Schatting: 125km/h	-270	450	Niet zichtbaar op Treinposities.nl
30	16:04	W=>O	IC ICM	4063	4028	126	-80	-14	
31	16:17	W=>O	Stoptrein Flirt	2508	2215	N.v.t. (aanzet vanaf stilstand)	-1043	725	
32	16:27	W=>O	Stoptrein Flirt	2523	2214	N.v.t. (aanzet vanaf stilstand)	-400	35	
33	16:34	W=>O	IC DDZ	7635	---	119	-202	77	
34	16:49	W=>O	Stoptrein Flirt	2224	2507	N.v.t. (aanzet vanaf stilstand)	-678	789	
35	16:57	W=>O	Stoptrein Flirt	25xx	---	N.v.t. (aanzet vanaf stilstand)	-450	50	Niet zichtbaar op Treinposities.nl
36	17:04	W=>O	IC DDZ	7609	---	117	-190	118	
37	17:17	W=>O	Stoptrein Flirt	2209	2510	N.v.t. (aanzet vanaf stilstand)	-880	408	
38	17:28	W=>O	Stoptrein Flirt	2202	2213	N.v.t. (aanzet vanaf stilstand)	-610	-110	
39	17:34	W=>O	IC DDZ	7649	---	132	-194	45	
40	17:48	W=>O	Stoptrein Flirt	2522	2207	N.v.t. (aanzet vanaf stilstand)	-950	660	
41	17:58	W=>O	Stoptrein Flirt	2228	2212	N.v.t. (aanzet vanaf stilstand)	-260	57	
42	18:03	W=>O	IC ICM	4247	4048	130	-76	39	
43	18:11	W=>O	Dieselloc + onderhoudsmachine	V100	---	Schatting: 80km/h	-760	-212	Dieselloc V100+onderhoudsmachine
44	18:19	W=>O	Stoptrein Flirt	2524	2210	N.v.t. (aanzet vanaf stilstand)	-525	1195	
45	18:34	W=>O	IC DDZ	7511	---	128	-199	-2	
46	18:52	W=>O	Stoptrein Flirt	2231	2517	N.v.t. (aanzet vanaf stilstand)	-160	1070	
47	19:04	W=>O	IC DDZ	7533	---	128	-236	95	
48	19:17	W=>O	Stoptrein Flirt	2222	2525	N.v.t. (aanzet vanaf stilstand)	-512	805	

49		W=>O	N.v.t	---	---	---	---	---	Referentiemeting stroomtangen
----	--	------	-------	-----	-----	-----	-----	-----	-------------------------------

Metingen Oss West, 23-11-2018

Weersomstandigheden: Droog, koud (ca.6°C)

Nr.	Time	Direction	Train type	Train serial number		Speed [km/h]	Estimated current during test [A]		Remarks
				1	2		Min	Max	
0	08:42	W=>O	IC DDZ	7608	---	120	-375	0	
1	08:52	W=>O	Stoptrein Flirt	2209	2518	N.v.t. (aanzet vanaf stilstand)	-200	850	
2	09:05	W=>O	IC DDZ	7521	7646	130	-300	0	
3	09:17	W=>O	Stoptrein Flirt	2221	2224	N.v.t. (aanzet vanaf stilstand)	-350	1200	
4	09:35	W=>O	IC DDZ	7632	---	125	-250	40	
5	09:48	W=>O	Stoptrein Flirt	2506	---	N.v.t. (aanzet vanaf stilstand)	-1000	800	
6	09:54	---	---	---	---	---	-100	30	No trains between Rosmalen and Oss
7	10:01	---	---	---	---	---	-115	-60	IC train passing substation near Geffen
8	10:03	W=>O	IC DDZ	7511	---	130	-150	150	No measurement, measurement software stopped
9	10:07	---	---	---	---	---	-135	70	IC train leaving Oss, passing substation near Berghem
10	10:27	W=>O	Stoptrein Flirt	2211	2228	N.v.t. (aanzet vanaf stilstand)	-448	1529	
11	10:53	W=>O	Stoptrein Flirt	2508	2229	N.v.t. (aanzet vanaf stilstand)	-450	1050	
12	11:04	W=>O	IC DDZ	7623	---	110	-125	110	
13	11:17	W=>O	Stoptrein Flirt	2213	2515	N.v.t. (aanzet vanaf stilstand)	-920	600	
14	11:25	---	---	---	---	---			nulmeting
15	11:35	W=>O	IC DDZ	7618	---	120	-100	250	
16	11:39	W=>O	Stoptrein Flirt	2204	2219	N.v.t. (aanzet vanaf stilstand)	-700	1200	
17	12:05	W=>O	IC ICM	4063	4245	140	-300	280	
18	12:15	O=>W	Stoptrein Flirt	2228	2211	aankomend vanuit Oss, remmend	-130	550	vanuit Oss, ander spoor
19	12:16	W=>O	Stoptrein Flirt	2215	---	N.v.t. (aanzet vanaf stilstand)	-400	-10	
20	12:27	O=>W	IC DDZ	7646	7521				vanuit Oss, ander spoor
21	12:35	W=>O	IC DDZ	7616	---	130	-140	110	
22	12:47	W=>O	Stoptrein Flirt	2525	2227	N.v.t. (aanzet vanaf stilstand)	-650	400	
23	12:57	O=>W	IC DDZ	7632					Ander spoor
24	13:04	W=>O	IC ICM	4247	4024	120	-150	250	

25	13:17	W=>O	Stoptrein Flirt	2522	---	N.v.t. (aanzet vanaf stilstand)	-625	325	Negatieve stroom is van vertrekkende trein vanaf ander perron, dit komt vaker voor in metingen
26	13:27	O=>W	IC DDZ	7xxxx	---				
27	13:34	W=>O	IC DDZ	7637	---		-175	40	
28	13:44	O=>W	Stoptrein Flirt	2xxx	2xxx	aankomend vanuit Oss, remmend			
29	13:47	W=>O	Stoptrein Flirt	2209	2518	N.v.t. (aanzet vanaf stilstand)	-350	800	
30	14:03	W=>O	IC DDZ	7614	---	120	-300	-150	
31	14:18	W=>O	Stoptrein Flirt	2221	---	N.v.t. (aanzet vanaf stilstand)	-180	820	
32	14:34	W=>O	IC DDZ	7608	---		-200	200	
33	14:47	W=>O	Stoptrein Flirt	2210	250x	N.v.t. (aanzet vanaf stilstand)	-750	900	
34	15:05	W=>O	IC DDZ	7521	7646	100	-225	100	
35	15:18	W=>O	Stoptrein Flirt	2211	2228	N.v.t. (aanzet vanaf stilstand)	-650	1200	
36	15:34	W=>O	IC DDZ	7632	---	130	-400	200	
37	15:45	O=>W	Stoptrein Flirt	2xxx		aankomend vanuit Oss, remmend			ander spoor
38	15:47	W=>O	Stoptrein Flirt	2508	2229	N.v.t. (aanzet vanaf stilstand)	-1200	1000	
39	15:51	W=>O	Stoptrein Flirt	2xxx	2xxx	doorgaand , lage snelheid (60)	-475	210	no measurement
40	16:03	W=>O	IC DDZ	7511	---	110	-380	-175	
41	16:18	W=>O	Stoptrein Flirt	2515	2213	N.v.t. (aanzet vanaf stilstand)	-550	870	
42	16:27	W=>O	Stoptrein Flirt	2512	---	N.v.t. (aanzet vanaf stilstand)	-280	50	Same time as Flirt leaves OssW: IC ICM on other track
43	16:34	W=>O	IC DDZ	7510	---	135	-700	20	
44	16:48	W=>O	Stoptrein Flirt	2219	2230	N.v.t. (aanzet vanaf stilstand)	-350	900	veel spikes
45	16:57	W=>O	Stoptrein Flirt	2514		N.v.t. (aanzet vanaf stilstand)	-350	70	Same time as Flirt leaves OssW: IC DDZ on other track
46	17:04	W=>O	IC DDZ	7637		130	-170	200	same time Traxx freight train other track
47	17:17	W=>O	Stoptrein Flirt	2231	2215	N.v.t. (aanzet vanaf stilstand)	-1100	600	
48	17:28	W=>O	Stoptrein Flirt	2220	2519	N.v.t. (aanzet vanaf stilstand)	-1400	-300	just before leaving IC DDZ passes on other track
49	17:33	W=>O	IC DDZ	7618		110	-100	50	
0									nulmeting

Metingen Oss West, 26-11-2018

Weersomstandigheden: Droog, koud (ca.7°C)

Nr.	Time	Direction	Train type	Train serial number		Speed [km/h]	Estimated current during test		Remarks
				1	2		Min	Max	
0	09:06	W=>O	IC DDZ	7510	7650	130	-400	325	
1	09:20	W=>O	Stoptrein Flirt	2211	2204	N.v.t. (aanzet vanaf stilstand)	-300	950	
2	09:34	W=>O	IC DDZ	7618	---	130	-140	150	
3	09:47	W=>O	Stoptrein Flirt	2217	2516		-225	1000	
4	09:56	O=>W	Stoptrein Flirt	2229	2508				
5	10:00	O=>W	IC DDZ	7647	7xxx				
6	10:04	W=>O	IC ICM	4063	4047	115	-250	120	
7	10:15	O=>W	Stoptrein Flirt	2216	2515				
8	10:18	W=>O	Stoptrein Flirt	2228	2507		-500	1200	
9	10:27	W=>O	diesel freight	---	---				
10	10:28	O=>W	IC DDZ	7625	---				
11	10:34	W=>O	IC DDZ	7608	---	130	-275	40	
12	10:45	O=>W	Stoptrein Flirt	2209	2518				
13	10:47	W=>O	Stoptrein Flirt	2501	2219		-200	1100	
14	10:57	O=>W	IC DDZ	7616	---	100			
15	11:04	W=>O	IC DDZ	7623	---	100	-150	-50	
16	11:16	W=>O	Stoptrein Flirt	2509	2212		-750	600	
17	11:34	W=>O	IC DDZ	7612	---		-225	-50	
18	11:45	O=>W	Stoptrein Flirt	2516	2217				
19	11:50	W=>O	Stoptrein Flirt	2232	2504		-370	900	
20	11:58	O=>W	IC DDZ	7637	---	100			
21	12:05	W=>O	IC ICM	4245	4028		-20	120	
22	12:13	---	---	---	---	---	---	---	nulmeting
23	12:49	W=>O	Stoptrein Flirt	2508	2229		-420	850	
24	12:58	O=>W	IC DDZ	7618	---	80			
25	13:04	W=>O	IC DDZ	7625	---	120	-220	120	
26	13:15	O=>W	Stoptrein Flirt	2212	2509				
27	13:17	W=>O	Stoptrein Flirt	2216	---		-600	250	
28	13:30	O=>W	IC ICM	4047	4065	100			
29	13:34	W=>O	IC DDZ	7616	---	130	-300	100	

30	13:45	O=>W	Stoptrein Flirt	2504	2232				
31	13:47	W=>O	Stoptrein Flirt	2209	---		-570	260	
32	13:57	O=>W	IC DDZ	7608	---				
33	14:03	W=>O	IC DDZ	7614	---	110	-120	-10	
34	14:15	O=>W	Stoptrein Flirt	2505	2233				
35	14:19	W=>O	Stoptrein Flirt	2211	2204		-150	850	
36	14:36	W=>O	IC DDZ	7637	---	135	-250	150	
37	14:44	O=>W	Stoptrein Flirt	2229	2508				
38	14:46	W=>O	Stoptrein Flirt	2217	2516		-650	1200	
39	14:57	O=>W	IC DDZ	7612	---	100			
40	15:04	W=>O	IC DDZ	7650	---	130	-200	75	
41	15:15	O=>W	Stoptrein Flirt	2216	---				
42	15:18	W=>O	Stoptrein Flirt	2228	2507		-350	1340	
43	15:27	O=>W	IC ICM	4245	4028				
44	15:34	W=>O	IC DDZ	7618		120	-250	100	
45	15:48	W=>O	Stoptrein Flirt	2501	2219		-517	1359	
46	15:51	W=>O	passing Flirt	2xxx	2xxx		-460	450	empty train
47	15:57	O=>W	IC DDZ	7647	7511	100			
48	16:02	O=>W	passing Flirt	2xxx	2xxx				empty train
49	16:04	W=>O	IC ICM	4063	4047	120	-150	30	
50	16:17	W=>O	Stoptrein Flirt	2509	2212		-750	950	
51	16:26	W=>O	Stoptrein Flirt	2220	2514		-800	-110	same time IC DDZ O>W
52	16:34	W=>O	IC DDZ	7608	---	130	-150	275	
53	16:48	W=>O	Stoptrein Flirt	2232	2504		-400	950	
54	16:58	W=>O	Stoptrein Flirt	2522	2506		-300	100	
55	17:04	W=>O	IC DDZ	7623	---	110	-100	60	
56	17:17	W=>O	Stoptrein Flirt	2505	2233		-1450	650	
57	17:28	W=>O	Stoptrein Flirt	2525	2201		-600	10	
58	17:34	W=>O	IC DDZ	7612	---	130	-250	20	

End of the the report