

# **Project Air cleaning in classrooms**

## **Report Activity A**

### **Testing of mobile air cleaning devices in the SenseLab**

Er Ding<sup>1</sup>, Arghyanir Giri<sup>1</sup>, Nadine Hobeika<sup>1</sup>, Antoine Gaillard<sup>2</sup>,  
Daniel Bonn<sup>2</sup>, Philomena M. Bluysen<sup>1</sup>

<sup>1</sup>Delft University of Technology, Delft, The Netherlands

<sup>2</sup>University of Amsterdam, Amsterdam, The Netherlands

Assigned by Ministerie van Onderwijs, Cultuur en Wetenschap  
Case number: 1325610

Delft, August 30, 2023

## **Abstract**

Mobile air cleaning devices can be used as an alternative air cleaning solution for classrooms where fresh air ventilation is limited. In this study seven types of mobile air cleaning devices were selected from 152 products for testing their feasibility of practical application, based on different criteria including air cleaning technology, airflow configuration, efficiency, clean air delivery rate (CADR), noise level, price, etc. The selected devices were evaluated in the SenseLab of Delft University of Technology, under different settings (operating levels) and configurations (layouts in the room), by 1) a particle decay test using an aerosol generator and particle sensors to investigate the particle removal rate and determine the CADR, and 2) a panel perception test using subjective votes and physical measurements to investigate the noise level and the risk of draft discomfort. The results showed that several mobile air cleaning devices can achieve the desired CADR (900-1000 m<sup>3</sup>/h) at maximum operating level under certain configurations, while it is then impossible to maintain a noise level lower than the requirement (35 dB[A]). However, according to the subjects' assessment of noise intensity and acceptability, some of the conditions were considered acceptable. In addition, the subjective evaluation of air movement was overall positive, indicating that draft discomfort is less likely to happen when the mobile air cleaning devices are under normal operation and is thus of less importance for product selection. In summary, to obtain both an acceptable CADR and noise level, four devices with specific conditions of setting and configuration, are recommended.

# Contents

	<b>Page</b>
Abstract	2
1. Introduction	4
2. Methods	5
2.1 Selection of mobile air cleaning devices	5
2.1.1 Collection of information on available mobile air cleaning devices	5
2.1.2 Major specifications of mobile air cleaning devices	5
2.1.3 Final selection of mobile air cleaning devices	7
2.2 Assessment of mobile air cleaning devices	10
2.2.1 Particle decay test	10
2.2.2 Panel perception test	13
3. Results and Discussion	14
3.1 Results of each tested air cleaning device	14
3.2 Discussion	17
3.2.1 Particle removal rate and CADR	17
3.2.2 Sound pressure level and sound perception	19
3.2.3 Air velocity and air movement perception	21
4. Conclusions	23
References	24
Symbols and abbreviations	25
Appendix A Forms for perception tests	26

## 1. Introduction

The COVID-19 pandemic has made it clear that airborne transmission of the coronavirus is a major source of infection, which can easily lead to outbreaks among people who share indoor spaces. During the COVID-19 pandemic, schools were often closed due to lockdowns or partially open, and windows and doors were mostly kept open when occupied, yet the ventilation in classrooms was still not satisfying. To ensure that schools can remain open even during future pandemics, it is therefore necessary to be able to implement measures that can reduce airborne transmission. One of those measures is to remove the exhaled virus-laden aerosols, preferably as close as possible to the source (infected person). This can be done through (personal) ventilation, with the aid of (local) air purification, or a combination thereof [1][2].

Previous studies have shown that the use of mobile air cleaning devices is potentially a good additional measure when only natural ventilation options are available in a classroom. However, such devices, for instance a mobile HEPA filter system, can cause unacceptable noise and draft (depending on the position of the device in the classroom) [3]. Moreover, more than one device might be required to fulfill the cleaning rate requirements.

To determine whether mobile air cleaning devices can be used in classrooms to reduce the risk of airborne transmission, the following questions were studied:

- Which types of mobile air cleaning devices are currently available for sufficiently cleaning the air of pathogens/viruses in classrooms?
- Which requirements do such devices have to meet to be applicable in classrooms?
- How many units of devices are needed per type and at which location should they be placed in classrooms to achieve an optimal result?

## 2. Methods

### 2.1 Selection of mobile air cleaning devices

#### 2.1.1 Collection of information on available mobile air cleaning devices

To collect information on the availability of mobile air cleaning devices applicable to school classrooms, existing products were searched within two ranges:

- 1) Professional organizations or associations, e.g., ISIAQ, ASHRAE, REHVA, etc.
- 2) Commercial dealers, e.g., Coolblue, MediaMarkt, BCC, Bol.com, Amazon.nl.

In total more than 300 products were found, and were further screened based on the following criteria, which resulted in a preliminary list of 152 mobile air cleaning devices:

- 1) The manufacturer has its own official (professional) website.
- 2) The manufacturer's main business is air handling products or it has more than one type of air cleaning product.
- 3) The main air cleaning technology of the product is HEPA and/or electrostatic and/or plasma (can also be combined with activated carbon and/or UV-C).
- 4) A list of technical specifications is provided for the product.
- 5) The product is available in or can be bought from the Netherlands.

#### 2.1.2 Major specifications of mobile air cleaning devices

The 152 products were then categorized and compared using eight parameters, based on the specifications provided by the manufacturer:

- 1) Air cleaning technology: The selected mobile air cleaning devices cover five main types of air cleaning technology, namely: HEPA, EPA, electrostatic (ES), plasma (PL), activated carbon (AC), and UV-C, which resulted in 15 types of combinations, as shown in Figure 1.
- 2) Airflow configuration: Airflow configuration of the mobile air cleaning device refers to the configuration of how room air is sucked in and supplied by the device (i.e., the configuration of airflow inlet and outlet). Figure 2 presents the 26 types of airflow configurations of the 152 products. The most common configuration of airflow inlet and outlet is horizontally from the side, and vertically from the top of the device, respectively.
- 3) Efficiency: The classification of the efficiency of air cleaning devices prescribed in the European standard EN 1822-1:2019 [4] is presented in Table 1. According to the specifications provided by the manufacturers, the particle removal efficiency of all the selected air cleaning devices is E12 or higher, which is equivalent to a removal efficiency of 0.3  $\mu\text{m}$  particles of  $\geq 99.95\%$ .
- 4) Fan capacity (or the CADR): The fan capacity means the maximum airflow rate the air cleaning device can provide, usually in  $\text{m}^3/\text{h}$ . Most of the selected air cleaning devices have multiple settings (fan levels). For some devices, instead of fan capacity, CADR (clean air delivery rate) is specified, which equals to the particle removal rate multiplied by the airflow rate, or the decrease of the particle concentration multiplied by the room volume, and thus indicates both the efficiency and fan capacity of the device. Since all the selected devices have an efficiency higher than 99.95%, the CADR can thus be considered as approximately equal to the fan capacity.
- 5) Sound level: The sound (noise) level of the mobile air cleaning devices varies with the fan settings, which can range from lower than 18 dB(A) to higher than 60 dB(A).
- 6) Dimensions: Normally the fan capacity of the mobile air cleaning device increases with the size. However, the devices should also be able to fit in the school classrooms causing minimum hinder to the teaching and learning activities.
- 7) Maintenance: The maintenance of the mobile air cleaning devices includes most importantly, the filter life, and its cost. The additional AC filter may also add to the cost, however for many produces the AC filter is combined with the main filter.
- 8) Price.

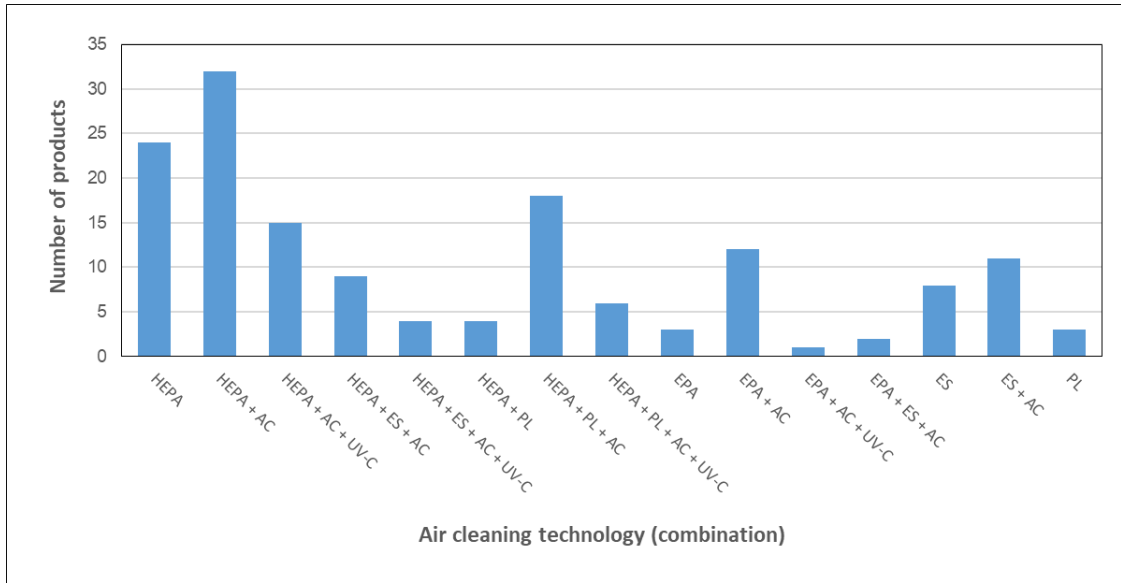

**Figure 1.** Number of selected air cleaning device products of different air cleaning technology (combinations).

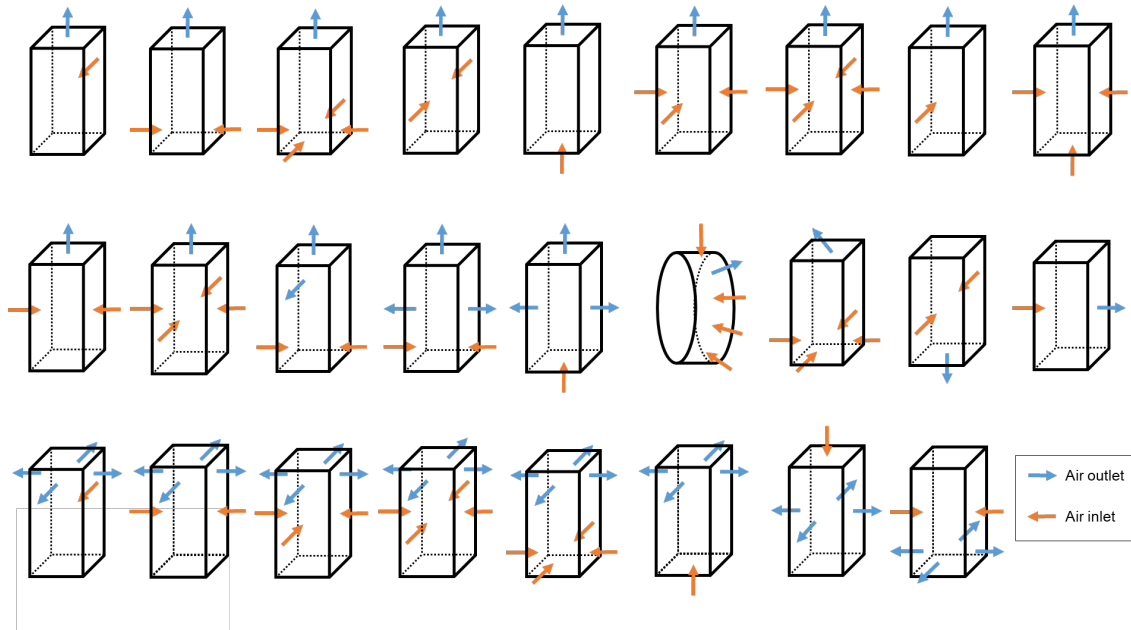

**Figure 2.** Airflow configurations of the selected mobile air cleaning devices.

**Table 1.** Classification of high efficiency air filters according to EN 1822-1:2019 [4].

Filter group	Filter class	Efficiency (%)
EPA <sup>a</sup>	E10	≥ 85
	E11	≥ 95
	E12	≥ 99.5
HEPA <sup>b</sup>	H13	≥ 99.95
	H14	≥ 99.995
ULPA <sup>c</sup>	U15	≥ 99.999 5
	U16	≥ 99.999 95
	U17	≥ 99.999 995

<sup>a</sup> EPA: efficient particulate air filter; <sup>b</sup> HEPA: high-efficiency particulate air filter; <sup>c</sup> ULPA: ultra-low penetration air filter.

### 2.1.3 Final selection of mobile air cleaning devices

To select the proper mobile air cleaning devices for further testing, several criteria have been determined considering both the technical requirements and feasibility of application for operating such devices in school classrooms:

- 1) Considering the type of tests being performed on the devices in this project, as well as the immaturity of real-life application, the mobile air cleaning devices that use UV-C technology were excluded.
- 2) To ensure better particle removal, H13 air filtering (and higher) is widely recommended. Hence, the mobile air cleaning devices with an efficiency lower than H13 were excluded.
- 3) According to the Dutch Fresh Schools guideline [5], the noise level of installations in school classrooms should be  $\leq 35$  dB(A). Therefore, the mobile air cleaning devices with a minimum noise level higher than 35 dB(A) were excluded.
- 4) For ventilation in school classrooms, a ventilation rate of 8~10 L/s per person is recommended to ensure occupants' health and comfort [6]. Taking the student occupancy in a typical classroom as 30 persons, the total required ventilation rate is thus around 900~1000 m<sup>3</sup>/h. Therefore, when operating the mobile air cleaning devices, the clean air delivery should be able to achieve such level. With regards to the size and fan capacity of the products, it was determined that the maximum units of devices that can be operated in one classroom is four, where each device should provide at least 250 m<sup>3</sup>/h of clean air. Hence, the mobile air cleaning devices with a maximum fan capacity lower than 250 m<sup>3</sup>/h were excluded.
- 5) Considering the affordability of the schools, the total budget of mobile air cleaning devices in one classroom is set to be 3000 euros. Thus, by multiplying the commercial unit price and number of units needed in one classroom, those who reached a total cost higher than 3000 euros were excluded.

Besides the aforementioned criteria, further selection was made by reducing the number of products from the same brands, as well as assessing the feasibility of the airflow configuration, which led to a shortlist of 27 products. The whole process is illustrated in Figure 3.

In the end, eight types of mobile air cleaning devices (noted as AP) were selected, based on another round of overall comparison. Each of these eight devices presents a different combination of air purifying technology, airflow configuration and fan capacity. The detailed information are listed in Table 2. It is worth noting that considering the fan capacity of AP5, one unit is required; while for AP1, AP4, AP6, and AP7, two units are required; and for AP2, AP3, and AP8, four units are required. The manufacturers of the devices were reached out after the selection was completed, yet until the end of the project the products of AP8 were not delivered, and thus had to be excluded from the study.

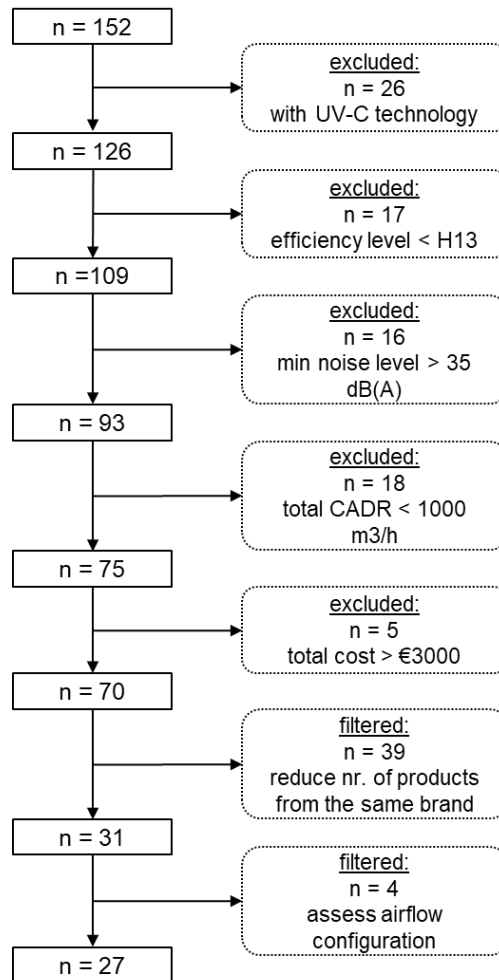

**Figure 3.** Flowchart of the selection process of mobile air cleaning devices.

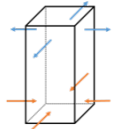
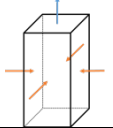
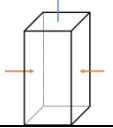
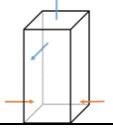
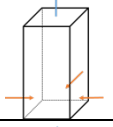
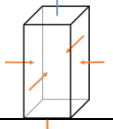
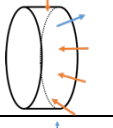
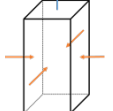

**Table 2.** Specifications of the selected mobile air cleaning devices.

Air cleaning device	Technology	Airflow configuration	Fan capacity (m <sup>3</sup> /h)	Efficiency	Sound [dB(A)]	Dimensions (cm)	Maintenance	Unit	Price (€)
AP1	HEPA + AC		1000	H13	Max. 62	19.0 × 19.6 × 101.8	Filter life: 4380 h Filter price (€): 75 AC life: combined AC price (€): -	2	500
AP2	HEPA + ES + AC		610	H13	19-57	30.6 (Φ) × 70.5	Filter life: 24 months Filter price (€): 100 AC life: combined AC price (€): -	4	480
AP3	ES		330	H13	19-53	27.0 × 27.0 × 50.0	Filter life: 10 years Filter price (€): -	4	380
AP4	ES + AC		735	H13	27-55	34.0 × 34.0 × 85.5	Filter life: 12 months Filter price (€): 160 AC life: combined AC price (€): -	2	1100
AP5	ES + AC		1386	H13	33-49	38.0 × 38.0 × 76.0	Filter life: 12 months Filter price (€): - AC life: - AC price (€): -	1	1900
AP6	HEPA		565	H13	18-51	33.2 x 33.6 x 60.6	Filter life: 12 months Filter price (€): 90	2	500
AP7	HEPA		750	H13	26-65	68.8 (Φ) x 25.4	Filter life: 18-24 months Filter price (€): 250	2	1500
AP8	HEPA + PL + AC		250	H13	27-54	24.1 (Φ) × 37.0	Filter life: 12 months Filter price (€): 30	4	100

## 2.2 Assessment of mobile air cleaning devices

The assessment of the final selected air cleaning devices consisted of two parts, namely the particle decay test and the panel perception test. The panel perception test also included physical measurements of sound pressure level and air velocity. All the tests were conducted during May to July 2023, in the Experience room of the SenseLab at the Delft University of Technology [7]. The Experience room has a size of 6.1 (l) × 4.2 (b) × 2.7 (h) m<sup>3</sup>, with two windows and one door, and the interior is set as a classroom, with tables, chairs, and a smartboard. The Experience room is equipped with both mixing and displacement ventilation systems, with a maximum ventilation rate of 1500 m<sup>3</sup>/h, and openable windows. The ventilation system is also equipped with a HEPA14 filter.

### 2.2.1 Particle decay test

#### Aerosol generator

An aerosol generator was adopted as the source of particles for the decay test, using an artificial saliva liquid made of 98.5 wt% water + 1 wt% glycerine + 0.5 wt% NaCl (salt). The aerosol generator consists of an HPLC pump (model: SHIMADZU LC-10AD), a Pulmospray<sup>TM</sup> (Medspray), and an air compressor [8]. The Pulmospray<sup>TM</sup> contains a nozzle (spray chip), a liquid tube, and an air tube. When the aerosol generator operates, the liquid is pumped from a bottle to the nozzle via the HPLC pump at a flow rate of 0.8~0.9 ml/min. It becomes multiple parallel liquid jets passing the nozzle and then break up into droplets, which are then mixed with the co-airflow to form a constant aerosol spray. The aerosol generator was placed in the middle of the Experience room, with the spray facing the front of the room (Figures 4 and 5).

#### Measurement instruments

The concentrations of particulate matter, PM<sub>2.5</sub> and PM<sub>10</sub>, were measured by six SDS011 air quality sensors, which were evenly placed on six tables in the Experience Room (Figure 5). The concentrations of VOC (Volatile organic compounds) and O<sub>3</sub> (Ozone) were measured by a Kanomax Gasmaster monitor (model: 2750) and an Aeroqual O<sub>3</sub> monitor (model: Series 500), respectively. These two monitors were placed on one table, close to the center of the room (Figure 5).

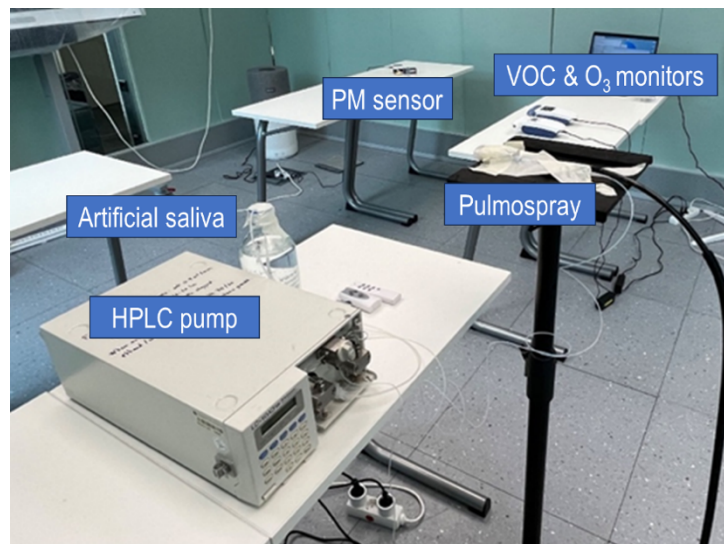

**Figure 4.** Set-up of the aerosol generator.

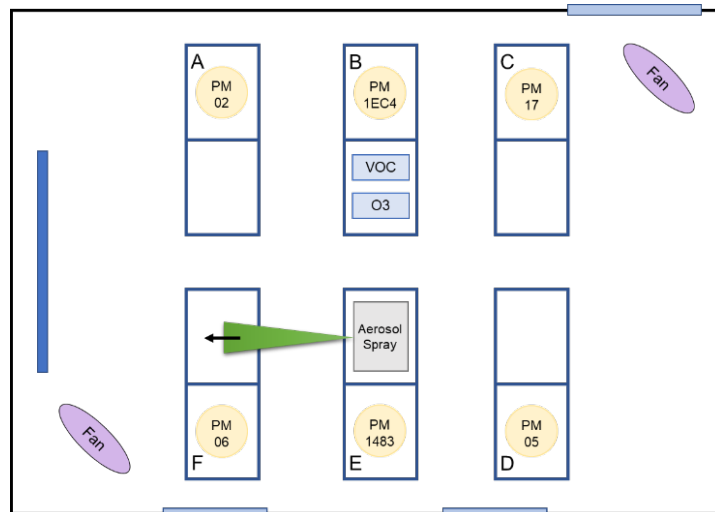

Figure 5. Set-up of the decay test.

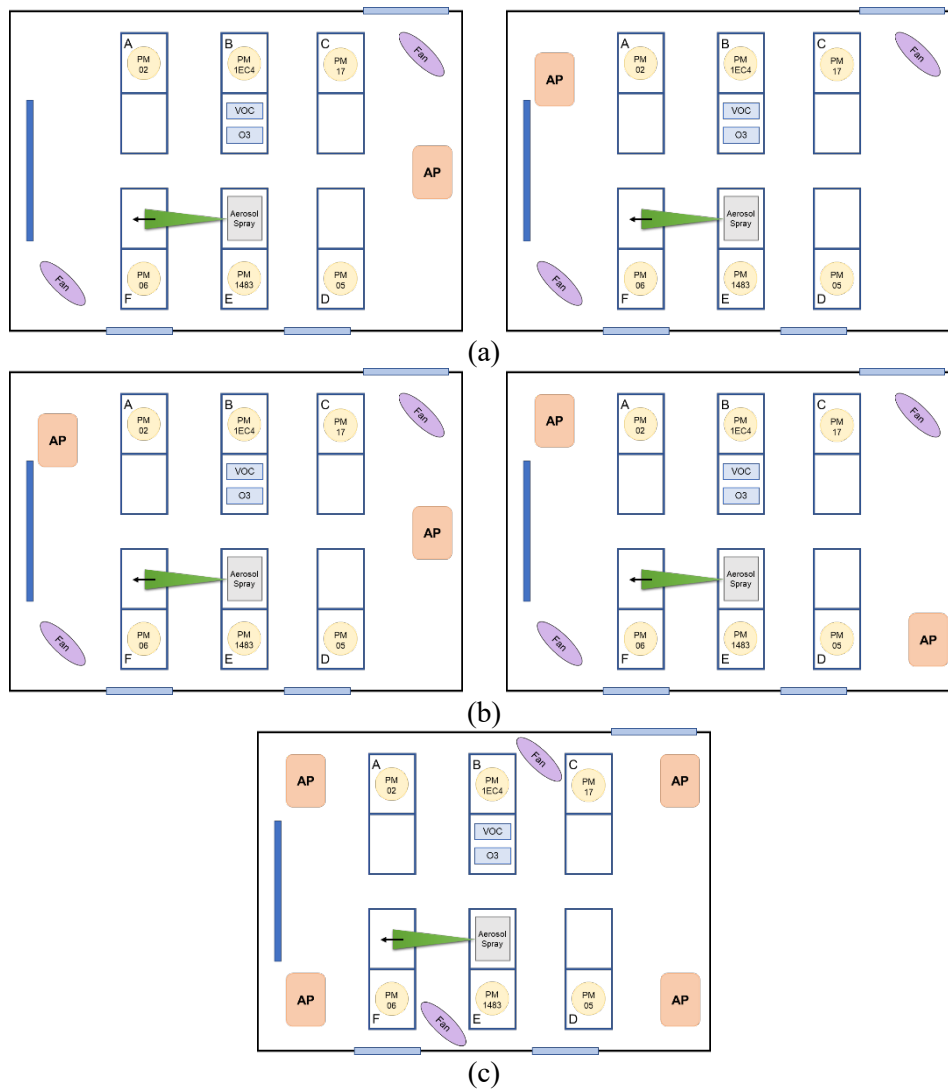

Figure 6. Configuration of the mobile air cleaning devices in the Experience Room. (a) One unit: left - C1, right - C2. (b) Two units: left - C1, right - C2. (c) Four units: C1.

### Test conditions and procedure

To determine the settings for the formal tests, for each type of mobile air cleaning device, a pre-test was performed to check the noise level of each setting. With the outcome two settings were selected for each type of device, one being the highest possible setting with a noise level lower than 35 dB(A), and the other being the maximum setting, noted as S1 and S2, respectively. Based on the number of units needed, each type of device was also tested under different configurations (layouts in the room), as shown in Figure 6. For the device with one unit, configuration 1 (C1) was with the device placed in the middle at the back of the room, and configuration 2 (C2) in the front, slightly on the side to avoid blocking the smartboard. For the device with two units, C1 was with one unit next to the smartboard in the front and the other in the middle at the back, C2 was diagonally in two corners. For the device with four units, there was only one configuration (C1), namely at four corners of the room. The total conditions tested for each type of device are listed in Table 3.

**Table 3.** Tested conditions for the selected mobile air cleaning devices.

Mobile air cleaning device	Tested settings*	Tested configurations	Number of conditions
AP1	S1 (L4), S2 (L10)	C1, C2	4
AP2	S1 (L1), S2 (L2)	C1	2
AP3	S1 (L2), S2 (L4)	C1	2
AP4	S1 (L1), S2 (L2)	C1, C2	4
AP5	S1 (L1), S2 (L5)	C1, C2	4
AP6	S1 (L4), S2 (L8)	C1, C2	4
AP7	S1 (L4), S2 (L8)	C1, C2	4

\* S: setting. L: device setting level. C: configuration.

Each decay test consists of a build-up session and a decay session. For the build-up, the aerosol generator was turned on for at least 1 h, to achieve a well-mixed condition of particles inside the room. Two floor fans were used to help accelerating the process (Figure 5). When the particle concentrations reached steady state, the build-up was completed and the aerosol generator and the fans were turned off, while the mobile air cleaning device(s) was(were) turned on simultaneously, after which the decay started. The decay session normally lasted for 1.5 h. During the test, everything was set to be remotely controlled except for AP5. Before and after each test, the mixing ventilation was turned on at an airflow rate of 1200 m<sup>3</sup>/h to help maintaining the particle concentrations in the room at a very low level (< 1 µg/m<sup>3</sup>).

### Particle removal rate and CADR

The particle concentration decay can be described by equation (1):

$$C(t) = C_0 e^{-kt} \quad (1)$$

where:

- $C$  is the particle concentration, µg/m<sup>3</sup>
- $C_0$  is the initial concentration of the decay process, µg/m<sup>3</sup>
- $k$  is the decay coefficient (here also the particle removal rate), h<sup>-1</sup>
- $t$  is the time after decay starts, h

Hence, the particle removal rate  $k$  of the mobile air cleaning devices can be determined using non-linear regression, here performed by IBM SPSS v.28. The CADR of the mobile air cleaning devices can be calculated by equation (2):

$$CADR = kV \quad (2)$$

where:

- $k$  is the particle removal rate, h<sup>-1</sup>
- $V$  is the volume of the room, m<sup>3</sup>

### 2.2.2 Panel perception test

#### Subjects and questionnaires

Eight PhD students (four males and four females, aged from 28 to 35 years) were recruited as subjects for the perception tests. For each perception test, a panel of six subjects (three male and three female) was formed to assess the sound and air movement created by the mobile air cleaning devices. For both sound and air movement, the subjects were asked to vote for the perception (feel/not feel), as well as intensity (quiet/loud, mild/strong) and assessment (pleasant/unpleasant) in the case they did sense any sound and/or air movement. For air movement, an extra question was added to ask the subjects to specify on which body part(s) they sensed the air movement (if there was any). The forms used are presented in Appendix A.

#### Test conditions and procedure

Based on the results of the decay test, the configuration with a higher particle removal rate and CADR was selected for each mobile air cleaning device to perform the perception test, combined with both settings. For AP5, AP6, and AP7, the difference between the two configurations was not significant, and thus both configurations were included for the perception test. When the subjects arrived, they were asked to rest for 10 minutes while completing a general information form to report the clothing they wore and their mood at the moment, after which they were seated at six tables in the Experience room (same as the decay test) (Figure 7). Each type of device was tested during an independent session, which started with an acclimatization period, and then the real test conditions began with the device(s) being turned on. Each condition lasted for 6 minutes, during which the device(s) was(were) turned on for 5 minutes, and then turned off during the last minute. The subjects were asked to complete the questionnaire at the 4th minute. The conditions were randomly assigned for each type of device, and after each session there was a break for switching the devices and preparing for the next session.

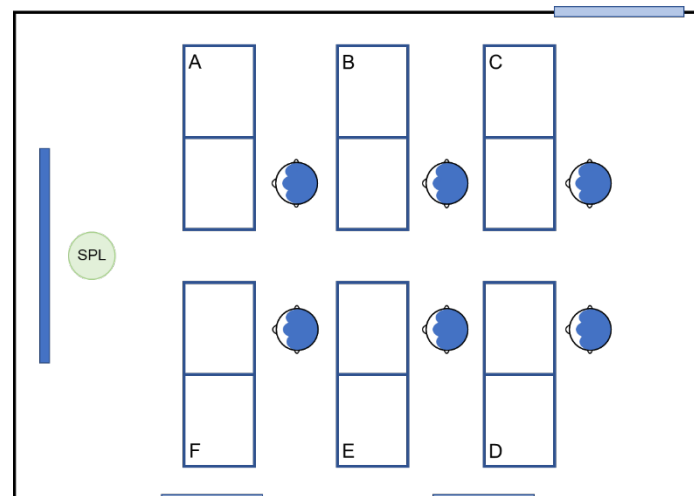

**Figure 7.** Set-up of the perception test.

#### Measurements of sound pressure level and air velocity

During the perception test, the sound pressure level was measured using a Norsonic sound analyzer (model: Nor140), which was placed in the front of the room (Figure 7). Both sound pressure level and air velocity were measured for the same conditions when the room was empty. For the sound pressure level, the sound analyzer was placed at the same location as shown in Figure 7, and each measurement lasted for 2 minutes. For the air velocity, a Dantec ComfortSense anemometer (model: 54T035) was used, which was placed in front of each table where the subjects were seated, at a height of 1.1 m, and each measurement lasted for 3 minutes.

### 3. Results and discussion

#### 3.1 Results of each tested air cleaning device

Tables 4 to 10 present the detailed results of the tested mobile air cleaning devices (AP1-AP7).

**Table 4.** Results of AP1.

Condition	S1_C1	S2_C1	S1_C2	S2_C2
$k_{PM2.5}$ ( $h^{-1}$ ) [mean (SD)]	2.216 (0.030)	5.061 (0.079)	2.862 (0.040)	5.234 (0.079)
$CADR_{PM2.5}$ ( $m^3/h$ ) [mean (SD)]	153.3 (2.1)	350.1 (5.2)	198 (2.7)	362.1 (5.5)
$k_{PM10}$ ( $h^{-1}$ ) [mean (SD)]	2.224 (0.055)	5.099 (0.095)	2.922 (0.092)	5.200 (0.172)
$CADR_{PM10}$ ( $m^3/h$ ) [mean (SD)]	153.8 (3.8)	352.7 (6.6)	202.1 (6.3)	359.7 (11.9)
VOC (ppm) [mean (SD)]	5.1 (0.8)	5.5 (1.4)	4.7 (0.8)	4.0 (0.2)
O <sub>3</sub> (ppm) [mean (SD)]	0.034 (0.003)	0.033 (0.004)	0.041 (0.002)	0.037 (0.003)
SPL <sub>empty</sub> [dB(A)] [mean (SD)]	-	-	32.4 (0.3)	47.9 (0.1)
SPL <sub>panel</sub> [dB(A)] [mean (SD)]	-	-	34.2 (2.2)	47.9 (0.1)
Sound perception (%)	-	-	100	100
Sound intensity [mean (SD)]	-	-	2.0 (1.3)	4.3 (0.5)
Sound assessment [mean (SD)]	-	-	2.2 (1.0)	4.5 (0.8)
Sound unacceptability (%) <sup>a</sup>	-	-	17	83
Air velocity at 1.1 m (m/s) [mean (SD)]	-	-	0.006 (0.004)	0.006 (0.005)
Air movement perception (%)	-	-	33	50
Air movement body part(s) <sup>b</sup>	-	-	face(1); neck(1)	face(1); neck(2)
Air movement intensity [mean (SD)]	-	-	1.0 (0)	2.0 (1.7)
Air movement assessment [mean (SD)]	-	-	1.5 (0.7)	2.3 (1.2)
Air movement unacceptability (%) <sup>c</sup>	-	-	0	0

<sup>a</sup> Percentage of sound assessment >3. <sup>b</sup> The numbers indicate number of subjects. <sup>c</sup> Percentage of air movement assessment >3.

**Table 5.** Results of AP2.

Condition	S1_C1	S2_C1
$k_{PM2.5}$ ( $h^{-1}$ ) [mean (SD)]	8.684 (0.169)	13.562 (0.734)
$CADR_{PM2.5}$ ( $m^3/h$ ) [mean (SD)]	600.7 (11.7)	938.1 (50.8)
$k_{PM10}$ ( $h^{-1}$ ) [mean (SD)]	8.825 (0.763)	13.682 (1.117)
$CADR_{PM10}$ ( $m^3/h$ ) [mean (SD)]	610.5 (52.8)	946.5 (77.2)
VOC (ppm) [mean (SD)]	1.4 (0.5)	3.6 (0.9)
O <sub>3</sub> (ppm) [mean (SD)]	0.038 (0.005)	0.035 (0.001)
SPL <sub>empty</sub> [dB(A)] [mean (SD)]	33.1 (1.8)	43.3 (0)
SPL <sub>panel</sub> [dB(A)] [mean (SD)]	34.3 (3.2)	45.7 (2.9)
Sound perception (%)	100	100
Sound intensity	2.2 (1.2)	3.7 (0.8)
Sound assessment	2.5 (1.0)	3.5 (1.0)
Sound unacceptability (%) <sup>a</sup>	17	50
Air velocity at 1.1 m (m/s) [mean (SD)]	0.025 (0.011)	0.077 (0.026)
Air movement perception (%)	67	83
Air movement body part(s) <sup>b</sup>	face (2); hand (1); arm (1)	face (3); neck (1); hand (2)
Air movement intensity	1.0 (0)	1.4 (0.5)
Air movement assessment	1.8 (0.5)	2.0 (0.7)
Air movement unacceptability (%) <sup>c</sup>	0	0

<sup>a</sup> Percentage of sound assessment >3. <sup>b</sup> The numbers indicate number of subjects. <sup>c</sup> Percentage of air movement assessment >3.

**Table 6.** Results of AP3.

Condition	S1_C1	S2_C1
$k_{PM2.5}$ ( $h^{-1}$ ) [mean (SD)]	7.097 (0.707)	15.715 (0.369)
$CADR_{PM2.5}$ ( $m^3/h$ ) [mean (SD)]	490.9 (48.9)	1087.1 (25.5)
$k_{PM10}$ ( $h^{-1}$ ) [mean (SD)]	7.753 (0.936)	16.673 (0.950)
$CADR_{PM10}$ ( $m^3/h$ ) [mean (SD)]	536.3 (64.8)	1153.3 (65.7)
VOC (ppm) [mean (SD)]	4.6 (0.5)	4.9 (0.4)
$O_3$ (ppm) [mean (SD)]	0.040 (0.003)	0.044 (0.004)
$SPL_{empty}$ [dB(A)] [mean (SD)]	29.9 (0.5)	49.7 (0.1)
$SPL_{panel}$ [dB(A)] [mean (SD)]	34.3 (0.2)	50.6 (1.5)
Sound perception (%)	83	100
Sound intensity	1.8 (0.8)	4.3 (0.8)
Sound assessment	2.2 (1.3)	4.0 (0.9)
Sound unacceptability (%) <sup>a</sup>	20	67
Air velocity at 1.1 m (m/s) [mean (SD)]	0.001 (0.001)	0.044 (0.029)
Air movement perception (%)	0	33
Air movement body part(s) <sup>b</sup>	-	face (2); chest (1)
Air movement intensity	-	1.5 (0.7)
Air movement assessment	-	2.0 (0)
Air movement unacceptability (%) <sup>c</sup>	-	0

<sup>a</sup> Percentage of sound assessment >3. <sup>b</sup> The numbers indicate number of subjects. <sup>c</sup> Percentage of air movement assessment >3.

**Table 7.** Results of AP4.

Condition	S1_C1	S2_C1	S1_C2	S2_C2
$k_{PM2.5}$ ( $h^{-1}$ ) [mean (SD)]	5.935 (0.325)	14.252 (0.436)	6.119 (0.264)	14.359 (0.414)
$CADR_{PM2.5}$ ( $m^3/h$ ) [mean (SD)]	410.5 (22.5)	985.9 (30.1)	423.3 (18.3)	993.3 (28.6)
$k_{PM10}$ ( $h^{-1}$ ) [mean (SD)]	5.820 (0.530)	13.844 (1.181)	6.074 (0.503)	14.151 (0.962)
$CADR_{PM10}$ ( $m^3/h$ ) [mean (SD)]	402.6 (36.7)	957.7 (81.7)	420.2 (34.8)	978.9 (66.5)
VOC (ppm) [mean (SD)]	4.5 (0.7)	4.7 (0.5)	5.0 (0)	4.9 (0.3)
$O_3$ (ppm) [mean (SD)]	0.034 (0.002)	0.034 (0.002)	0.035 (0.002)	0.036 (0.002)
$SPL_{empty}$ [dB(A)] [mean (SD)]	-	-	28.3 (0.5)	45.0 (0)
$SPL_{panel}$ [dB(A)] [mean (SD)]	-	-	30.5 (1.2)	45.4 (2.0)
Sound perception (%)	-	-	100	100
Sound intensity [mean (SD)]	-	-	1.3 (0.8)	3.7 (1.5)
Sound assessment [mean (SD)]	-	-	1.5 (0.8)	3.5 (1.0)
Sound unacceptability (%) <sup>a</sup>	-	-	0	50
Air velocity at 1.1 m (m/s) [mean (SD)]	-	-	0.004 (0.003)	0.043 (0.027)
Air movement perception (%)	-	-	0	67
Air movement body part(s) <sup>b</sup>	-	-	-	face (2); chest (1); arm (1); hand (2)
Air movement intensity [mean (SD)]	-	-	-	1.8 (0.5)
Air movement assessment [mean (SD)]	-	-	-	2.3 (1.0)
Air movement unacceptability (%) <sup>c</sup>	-	-	-	0

<sup>a</sup> Percentage of sound assessment >3. <sup>b</sup> The numbers indicate number of subjects. <sup>c</sup> Percentage of air movement assessment >3.

**Table 8. Results of AP5.**

Condition	S1_C1	S2_C1	S1_C2	S2_C2
$k_{PM2.5}$ ( $h^{-1}$ ) [mean (SD)]	6.294 (0.277)	10.809 (0.255)	7.484 (0.913)	13.190 (1.189)
$CADR_{PM2.5}$ ( $m^3/h$ ) [mean (SD)]	435.4 (19.1)	747.7 (17.6)	517.7 (63.1)	912.4 (82.3)
$k_{PM10}$ ( $h^{-1}$ ) [mean (SD)]	6.136 (0.380)	10.774 (0.864)	7.867 (1.070)	14.446 (1.388)
$CADR_{PM10}$ ( $m^3/h$ ) [mean (SD)]	424.4 (26.3)	745.3 (59.8)	544.2 (74.0)	999.3 (96.0)
VOC (ppm) [mean (SD)]	3.0 (0.2)	5.0 (0)	4.9 (0.3)	4.2 (0.5)
$O_3$ (ppm) [mean (SD)]	0.040 (0.001)	0.037 (0.001)	0.046 (0.001)	0.046 (0.003)
$SPL_{empty}$ [dB(A)] [mean (SD)]	26.9 (0.4)	46.2 (0.1)	27.2 (0.3)	48.1 (0.4)
$SPL_{panel}$ [dB(A)] [mean (SD)]	33.4 (5.7)	46.7 (1.5)	29.8 (2.6)	49.5 (3.3)
Sound perception (%)	100	100	100	100
Sound intensity [mean (SD)]	1.7 (1.2)	4.5 (0.5)	1.3 (0.8)	3.2 (1.2)
Sound assessment [mean (SD)]	2.0 (1.3)	4.3 (0.5)	2.0 (1.3)	3.3 (1.0)
Sound unacceptability (%) <sup>a</sup>	17	100	17	33
Air velocity at 1.1 m (m/s) [mean (SD)]	0.020 (0.009)	0.077 (0.032)	0.011 (0.011)	0.051 (0.034)
Air movement perception (%)	17	50	17	17
Air movement body part(s) <sup>b</sup>	face (1)	face(2); head(1) arm(1) and (3); thigh(1)	arm (1)	arm (1)
Air movement intensity [mean (SD)]	1.0 (-)	2.3 (1.5)	1.0 (-)	2.0 (-)
Air movement assessment [mean (SD)]	2.0 (-)	2.0 (1.0)	4.0 (-)	3.0 (-)
Air movement unacceptability (%) <sup>c</sup>	0	0	100	0

<sup>a</sup> Percentage of sound assessment >3. <sup>b</sup> The numbers indicate number of subjects. <sup>c</sup> Percentage of air movement assessment >3.

**Table 9. Results of AP6.**

Condition	S1_C1	S2_C1	S1_C2	S2_C2
$k_{PM2.5}$ ( $h^{-1}$ ) [mean (SD)]	7.370 (0.121)	14.544 (0.590)	5.892 (0.168)	13.370 (0.207)
$CADR_{PM2.5}$ ( $m^3/h$ ) [mean (SD)]	509.8 (8.4)	1006.1 (40.8)	407.5 (11.6)	924.8 (14.3)
$k_{PM10}$ ( $h^{-1}$ ) [mean (SD)]	7.668 (0.226)	15.445 (0.888)	6.112 (0.207)	13.812 (0.509)
$CADR_{PM10}$ ( $m^3/h$ ) [mean (SD)]	530.4 (15.6)	1068.4 (61.4)	422.8 (14.3)	955.4 (35.2)
VOC (ppm) [mean (SD)]	6.5 (0.5)	5.1 (0.8)	8.2 (0.4)	8.9 (0.3)
$O_3$ (ppm) [mean (SD)]	0.044 (0.001)	0.046 (0.006)	0.037 (0.003)	0.037 (0.002)
$SPL_{empty}$ [dB(A)] [mean (SD)]	29.8 (0.2)	44.6 (0.3)	29.5 (0)	45.3 (0.1)
$SPL_{panel}$ [dB(A)] [mean (SD)]	31.2 (1.6)	45.6 (1.8)	31.6 (2.0)	44.4 (1.2)
Sound perception (%)	100	100	100	100
Sound intensity [mean (SD)]	1.5 (0.8)	2.7 (0.8)	1.8 (0.8)	4.0 (0.6)
Sound assessment [mean (SD)]	2.0 (1.3)	2.8 (0.8)	2.0 (0.9)	3.8 (0.8)
Sound unacceptability (%) <sup>a</sup>	17	17	0	67
Air velocity at 1.1 m (m/s) [mean (SD)]	0.011 (0.006)	0.067 (0.024)	0.033 (0.022)	0.105 (0.037)
Air movement perception (%)	50	67	0	83
Air movement body part(s) <sup>b</sup>	face (1); neck (1); shoulder (1)	face (2); neck (1); shoulder (1); hand (1)	-	face (3); head (1); neck (1); hand (2); thigh (1); ankle (1)
Air movement intensity [mean (SD)]	1.3 (0.6)	1.5 (0.6)	-	1.6 (0.9)
Air movement assessment [mean (SD)]	2.0 (1.0)	1.8 (1.0)	-	1.6 (0.5)
Air movement unacceptability (%) <sup>c</sup>	0	0	-	0

<sup>a</sup> Percentage of sound assessment >3. <sup>b</sup> The numbers indicate number of subjects. <sup>c</sup> Percentage of air movement assessment >3.



**Table 10.** Results of AP7.

Condition	S1_C1	S2_C1	S1_C2	S2_C2
$k_{PM_{2.5}}$ ( $h^{-1}$ ) [mean (SD)]	9.527 (0.157)	19.701 (0.871)	11.248 (0.327)	19.284 (0.830)
$CADR_{PM_{2.5}}$ ( $m^3/h$ ) [mean (SD)]	659.0 (10.8)	1362.8 (60.3)	778.1 (22.6)	1334.0 (57.4)
$k_{PM_{10}}$ ( $h^{-1}$ ) [mean (SD)]	8.508 (0.172)	19.701 (0.871)	10.591 (0.343)	19.059 (0.506)
$CADR_{PM_{10}}$ ( $m^3/h$ ) [mean (SD)]	588.5 (11.9)	1362.8 (60.3)	732.6 (23.8)	1318.4 (35.0)
VOC (ppm) [mean (SD)]	0.6 (0.5)	1.0 (0.0)	1.8 (0.4)	2.0 (0.0)
O <sub>3</sub> (ppm) [mean (SD)]	0.046 (0.006)	0.047 (0.006)	0.049 (0.005)	0.046 (0.007)
SPL <sub>empty</sub> [dB(A)] [mean (SD)]	33.4 (0.2)	49.2 (0.3)	32.1 (0.1)	50.5 (0.2)
SPL <sub>panel</sub> [dB(A)] [mean (SD)]	35.6 (2.1)	53.1 (1.5)	35.2 (3.4)	52.3 (2.8)
Sound perception (%)	100	100	100	100
Sound intensity [mean (SD)]	2.7 (0.8)	4.7 (0.8)	1.7 (1.2)	4.2 (1.2)
Sound assessment [mean (SD)]	2.7 (0.8)	4.8 (0.4)	2.2 (1.2)	4.2 (1.0)
Sound unacceptability (%) <sup>a</sup>	17	100	17	67
Air velocity at 1.1 m (m/s) [mean (SD)]	0.065 (0.027)	0.197 (0.072)	0.094 (0.041)	0.268 (0.119)
Air movement perception (%)	83	83	83	83
Air movement body part(s) <sup>b</sup>	face (2); head (1); neck (1); chest (1); arm (1); leg (1)	face (2); neck (1); shoulder (1); arm (1); leg (2)	face (1); head (1); arm (3); hand (1); leg (1)	face (2); head (1); neck (1); arm (3); hand (1); leg (1)
Air movement intensity [mean (SD)]	1.4 (0.5)	2.6 (0.9)	1.2 (0.4)	2.6 (0.5)
Air movement assessment [mean (SD)]	2.0 (0.7)	1.8 (0.8)	1.6 (0.9)	1.8 (0.4)
Air movement unacceptability (%) <sup>c</sup>	0	0	0	0

<sup>a</sup> Percentage of sound assessment >3. <sup>b</sup> The numbers indicate number of subjects. <sup>c</sup> Percentage of air movement assessment >3.

### 3.2 Discussion

#### 3.2.1 Particle removal rate and CADR

The comparisons of particle removal rate and CADR of both PM<sub>2.5</sub> and PM<sub>10</sub> among the mobile air cleaning devices are shown in Figures 8 to 11. As mentioned in section 2.1.3, for a typical classroom, a clean air delivery rate of 900~1000 m<sup>3</sup>/h is desired. According to the results, a few of the selected mobile air cleaning devices can reach such level (marked by the green line in Figures 10 and 11), but only under the maximum setting, which inevitably cause a noise level way higher than 35 dB(A). However, since real classrooms also always involve vocal activities during teaching and learning, a slightly higher background sound level can be considered acceptable if supported by the results of the perception test, which will be discussed in section 3.2.2. It is also worth noting that for AP7, when placed as configuration 1, the CADR of both PM<sub>2.5</sub> and PM<sub>10</sub> can almost reach 800 m<sup>3</sup>/h, which is approximately 7.5 l/s per person (assuming 30 students per classroom), and does fulfill the minimum requirement (6 l/s per person) prescribed by the Dutch Fresh Schools guideline [3].

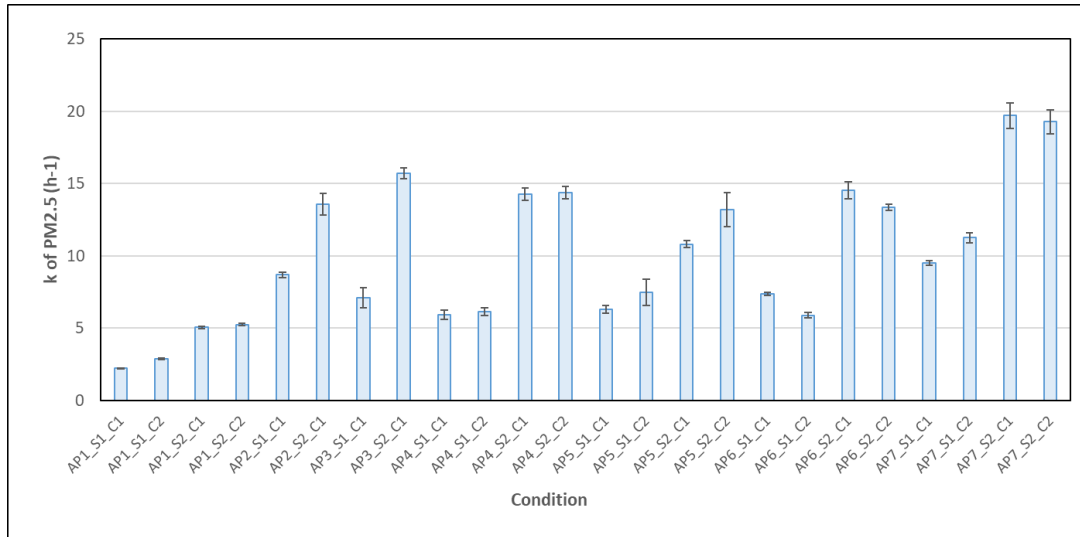

**Figure 8.** Particle removal rate of PM<sub>2.5</sub>.

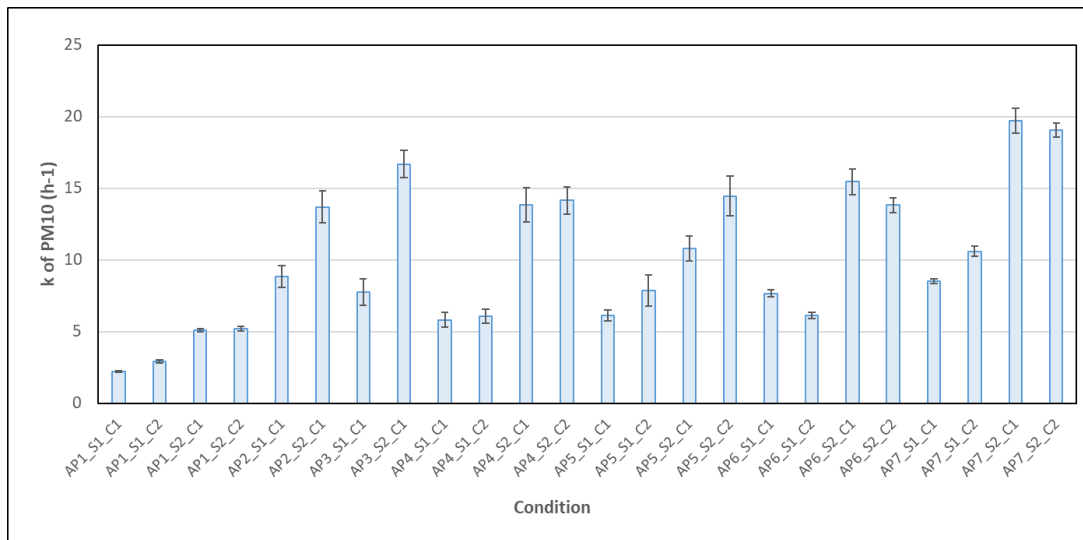

**Figure 9.** Particle removal rate of PM<sub>10</sub>.

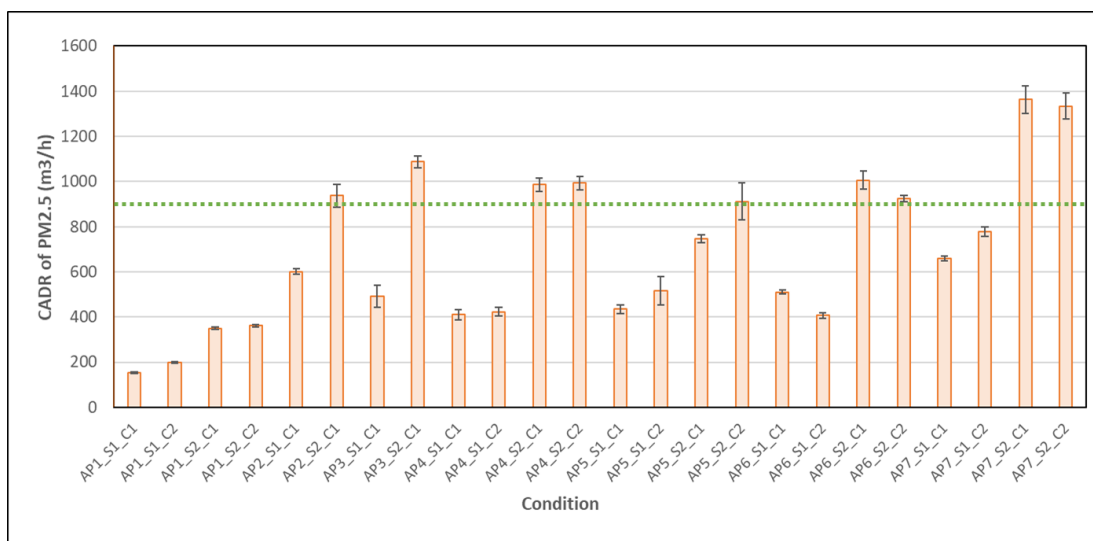

**Figure 10.** CADR of PM<sub>2.5</sub>.

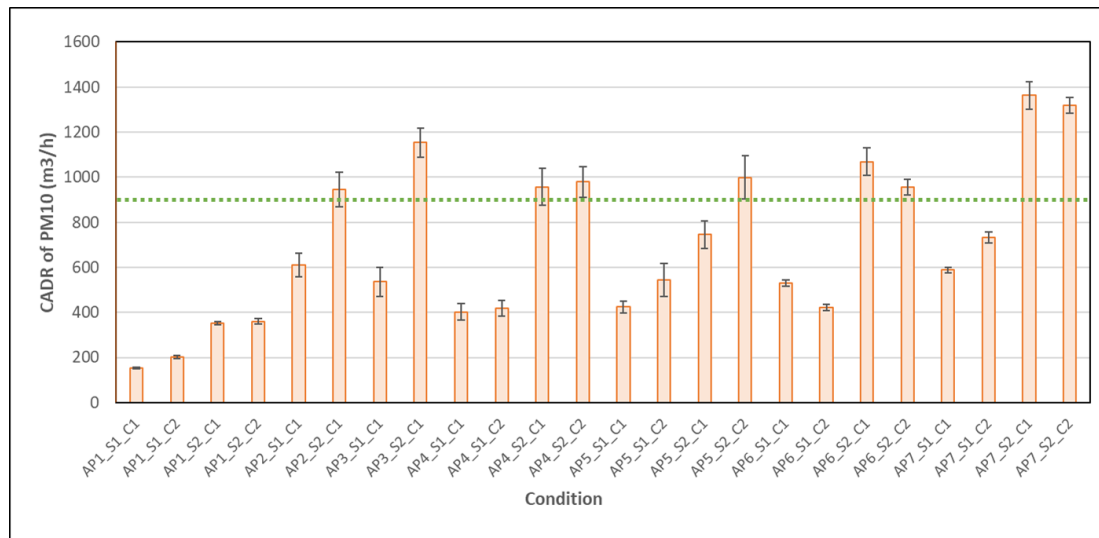

**Figure 11.** CADR of PM<sub>10</sub>.

### 3.2.2 Sound pressure level and sound perception

The comparisons of sound perception, sound intensity, and sound assessment among the mobile air cleaning devices are shown in Figures 12 to 14. Under most conditions the sound generated by the mobile air cleaning devices are perceptible by all the subjects. For AP2, the condition that fulfills the CADR requirement was S2\_C1, of which the average noise level was 43.3 dB(A) (empty room), and perception-wise the average sound intensity was 3.7 out of 5, with 50% of the subjects rated the sound as acceptable (Table 5). For AP3, the condition that fulfilled the CADR requirement was S2\_C1, of which the average noise level was 49.7 dB(A) (empty room), and perception-wise the average sound intensity was 4.3 out of 5, with 33% of the subjects rated the sound as acceptable (Table 6). For AP4, the conditions that fulfilled the CADR requirement were S2 with both configurations, while S2\_C2 showed a better performance, of which the average noise level was 45.0 dB(A) (empty room), and perception-wise the average sound intensity was 3.7 out of 5, with 50% of the subjects rated the sound as acceptable (Table 7). For AP5, the condition that fulfilled the CADR requirement was S2\_C2, of which the average noise level was 48.1 dB(A) (empty room), and perception-wise the average sound intensity was 3.2 out of 5, with 67% of the subjects rated the sound as acceptable (Table 8). For AP6, the conditions that fulfilled the CADR requirement were S2 with both configurations, while S2\_C1 showed a better performance, of which the average noise level was 44.6 dB(A) (empty room), and perception-wise the average sound intensity was 2.7 out of 5, with 83% of the subjects rated the sound as acceptable (Table 9). For AP7, when the devices were operating at S1, the average noise level remained lower than 35 dB(A) (empty room), and under condition S1\_C2 the average sound intensity was 1.7 out of 5, with 83% of the subjects rated the sound as acceptable. On the other hand, although S2\_C1 achieved the highest CADR, the average noise level was measured to be 49.2 dB(A) (empty room), with an average sound intensity of 4.7 out of 5, and 100% of the subjects rated the sound as unacceptable (Table 10).

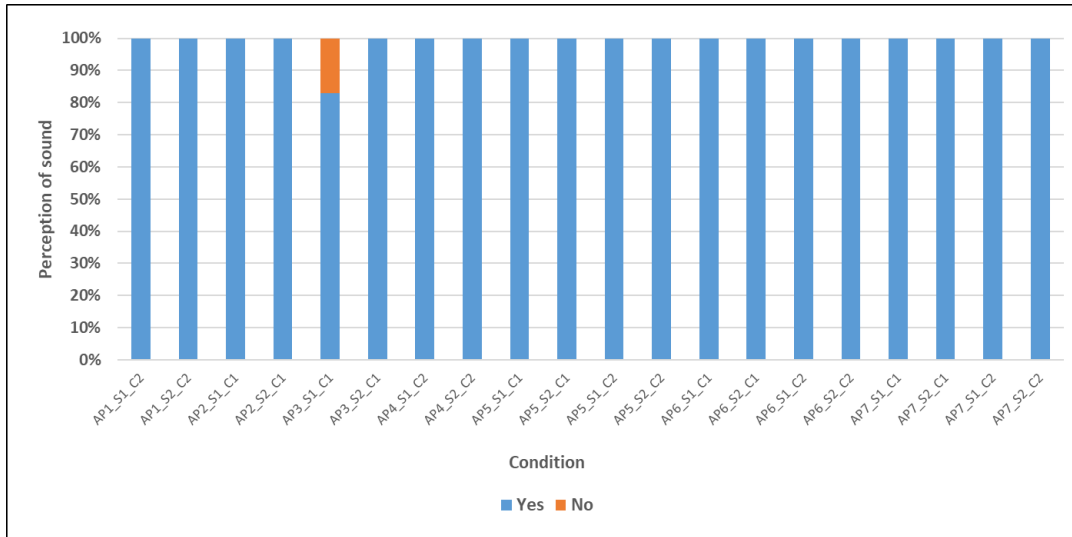

**Figure 12.** Perception of sound of the mobile air cleaning devices.

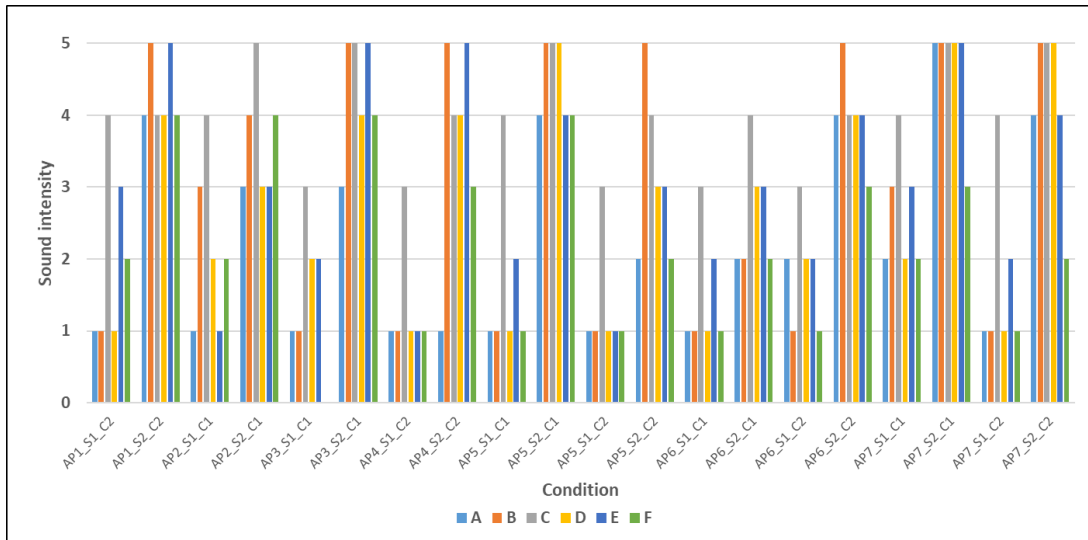

**Figure 13.** Vote of the sound intensity of the mobile air cleaning devices.

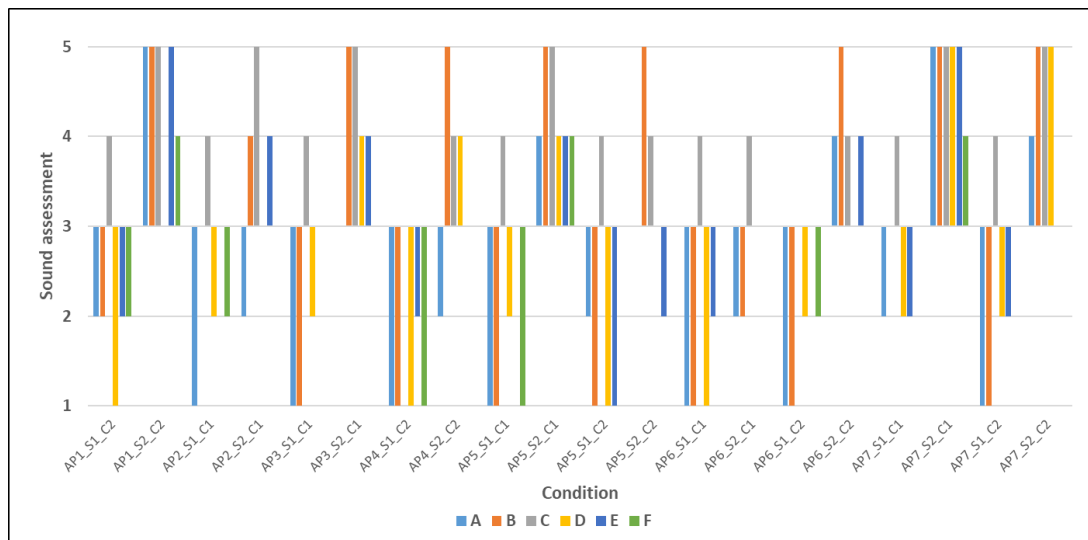

**Figure 14.** Vote of the sound assessment of the mobile air cleaning devices.

### 3.2.3 Air velocity and air movement perception

The comparisons of sound perception, sound intensity, and sound assessment among the mobile air cleaning devices are shown in Figures 15 to 17. Although under most of the conditions the air movement generated by the mobile air cleaning devices can be perceived by more the half of the subjects, the intensity of the air movement was in general rated low, and almost under all cases the subjects rated it as acceptable. In addition, according to the results of the measurement, the air velocity was always lower than 0.2 m/s (not likely to cost draft discomfort), except for AP7 under S2\_C2 (Tables 4 to10). Therefore, it can be concluded that the air movement that the mobile air cleaning devices create had a positive effect on occupants' comfort when no other ventilation was available in the room.

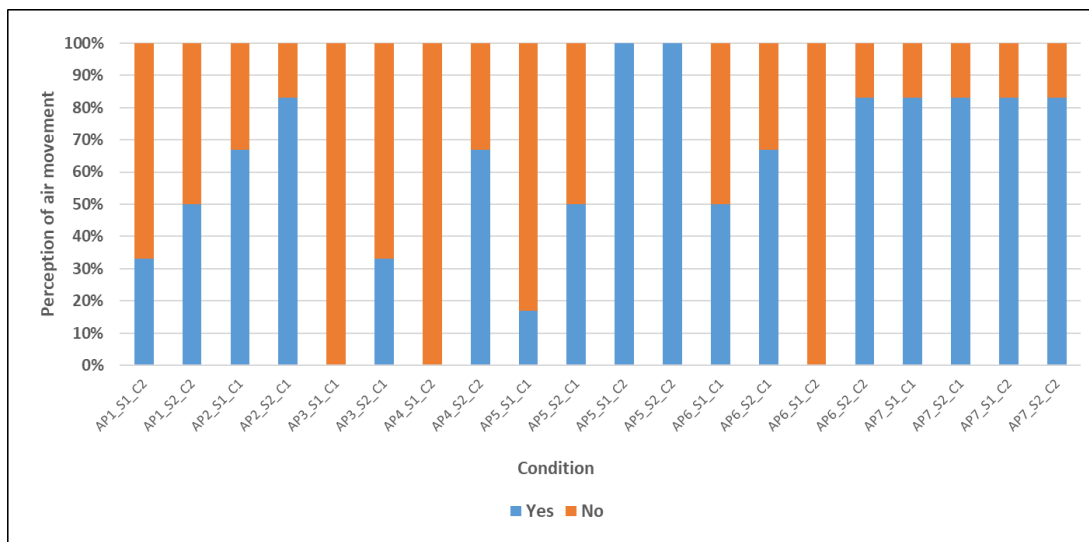

Figure 15. Perception of air movement of the mobile air cleaning devices.

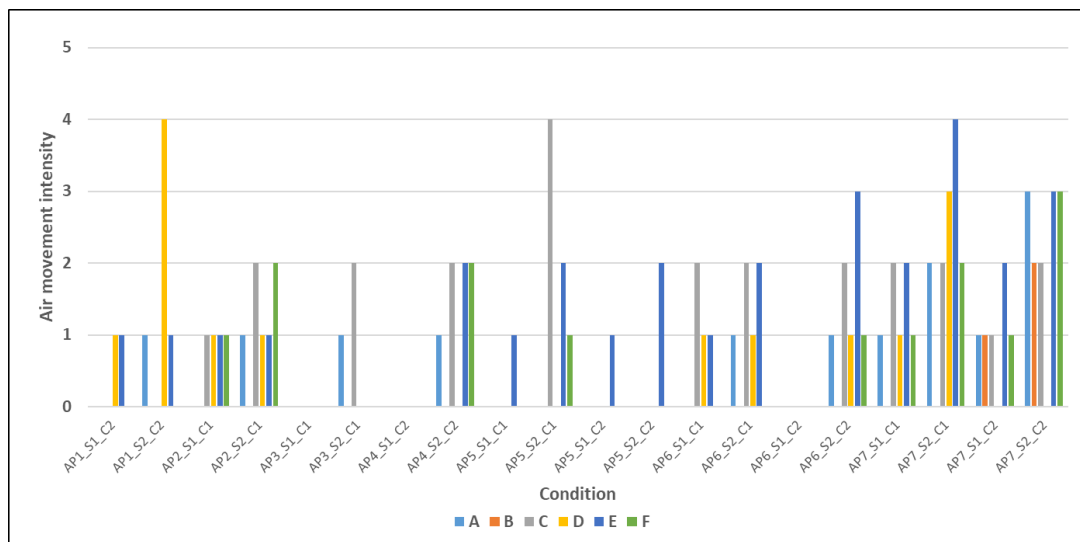
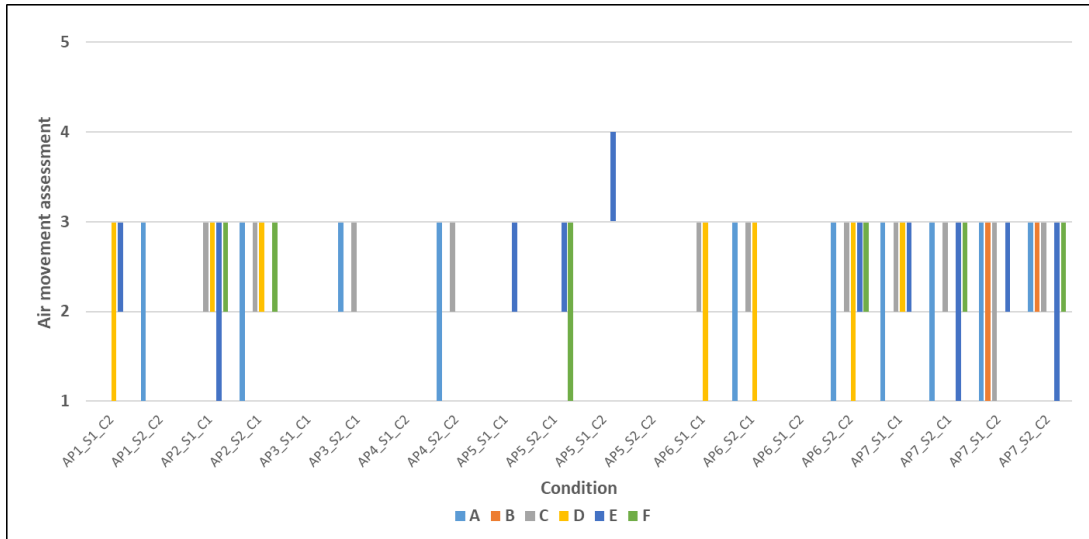

Figure 16. Vote of the air movement intensity of the mobile air cleaning devices.



**Figure 17.** Vote of the air movement assessment of the mobile air cleaning devices.







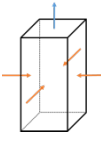

## 4. Conclusions

In this project seven different types of mobile air cleaning devices were tested on their feasibility of applying them into school classrooms as an alternative solution when ventilation is limited. The assessment consisted of a particle decay test and a panel perception test, which covered three key factors of the utilization of mobile air cleaning devices, namely the particle removal ability (CADR), the noise level, and the risk of draft discomfort.

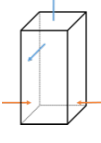
As the results showed that the air movement generated by the devices has in fact led to positive perception, the only concern for selecting the proper device ended in the tradeoff between particle removal efficiency and noise level. It has been indicated that to achieve the desired amount of clean air delivery, none of the selected devices could maintain a noise level fulfilling the requirement of lower than 35 dB(A) [4]. However, considering the results of the perception tests, several configurations can be considered as acceptable for use in classrooms (see Table 11):

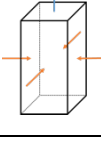
- AP2, with four units of devices operating at device setting L2;
- AP4, with two units of devices operating at device setting L2, configuration 2;
- AP6, with two units of devices operating at device setting L8, configuration 1;
- AP7, with two units of devices operating at device setting L4, configuration 2.

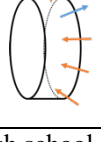
**Table 11.** Selected devices and configurations.

Air cleaning device	Technology	Airflow pattern	Number of units & configuration	Device setting	CADR [m <sup>3</sup> /h] (PM <sub>2.5</sub> and PM <sub>10</sub> )	Sound level [dB(A)]	% acceptable
AP2	HEPA + ES + AC		4 	L2	938 933	43.3	50
AP4	ES + AC		2 	L2	993 979	45.0	50
AP6	HEPA		2 	L8	1006 1068	44.6	83
AP7 <sup>a</sup>	HEPA		2 	L4	778 733	32.1	83

a: Fulfils nearly the Dutch fresh school guidelines.

## References

1. Ding E, Zhang D, & Bluysen, PM. (2022). Ventilation regimes of school classrooms against airborne transmission of infectious respiratory droplets: A review. *Building and Environment* 207: 108484. <https://doi.org/10.1016/j.buildenv.2021.108484>.
2. Ding E, Zhang D, Hamida A, García-Sánchez C, Jonker L, de Boer AR, Bruijning PCJL, Linde KJ, Wouters IM, & Bluysen PM. (2023). Ventilation and thermal conditions in secondary schools in the Netherlands: Effects of COVID-19 pandemic control and prevention measures. *Building and Environment*: 109922. <https://doi.org/10.1016/j.buildenv.2022.109922>.
3. Bluysen PM, Ortiz M & Zhang D. (2021). The effect of a mobile HEPA filter system on ‘infectious’ aerosols, sound and air velocity in the SenseLab. *Building and environment* 188: 107475. <https://doi.org/10.1016/j.buildenv.2020.107475>.
4. ECN (2019) High efficiency air filters (EPA, HEPA and ULPA) - Part 1: Classification, performance testing, marking, EN 1822-1:2019, Brussels: European Committee for Standardization.
5. Netherlands Enterprise Agency (2021) Program of Requirements – Fresh Schools, May 2021. Accessed: Jul. 01, 2021. (in Dutch) [Online]. Available: <https://www.rvo.nl/sites/default/files/2021/06/PvE-Frisse-Scholen-2021.pdf>.
6. Qian H, Miao T, Liu L, Zheng X, Luo D, Li Y (2021) Indoor transmission of SARS- CoV-2, *Indoor Air* 31(3):639-645, <https://doi.org/10.1111/ina.12766>.
7. Bluysen PM, van Zeist F, Kurvers S, Tenpierik M, Pont S, Wolters B, van Hulst L, Meertins D. (2018) The creation of SenseLab: A laboratory for testing and experiencing single and combinations of indoor environmental conditions, *Intelligent Buildings International* 10(1):5-18. <https://doi.org/10.1080/17508975.2017.1330187>
8. Gaillard A, Lohse D, Bonn D, Yigit F (2023) Reconciling airborne disease transmission concerns with energy saving requirements: the potential of UV-C pathogen deactivation and air distribution optimization, *Indoor Air* 2023: 3927171, <https://doi.org/10.1155/2023/3927172>.



## **Symbols and abbreviations**

AC	Activated carbon
AP	Air purifier
ASHRAE	American Society of Heating, Refrigerating and Air-Conditioning Engineers
CADR	Clean air delivery rate
EPA	Efficient particulate air filter
ES	Electrostatic
HEPA	High-efficiency particulate air filter
HPLC	High-performance liquid chromatography
ISIAQ	International Society of Indoor Air Quality and Climate
PL	Plasma
REHVA	Federation of European Heating, Ventilation and Air Conditioning Associations
SD	Standard deviation
SPL	Sound pressure level
ULPA	Ultra-low penetration air filter
UV-C	Ultraviolet germicidal irradiation (180-280 nm)
VOC	Volatile organic compounds

## Appendix A Forms for perception tests

### General Information

1. Age \_\_\_\_\_ years

2. Gender

Male

Female

3. Which of the 9 images best suits how you feel at this moment?



4. Please briefly describe the type of clothing you are wearing at this moment.

Top:

\_\_\_\_\_

Bottom:

\_\_\_\_\_

Shoes:

\_\_\_\_\_

## Questionnaire of Sound and Air Movement Perception

### Part 1. Assessment of sound

1.1 Can you hear any sound at the location where you are sitting?

Yes

No

(If the answer is **Yes**, please continue with question 1.2 and 1.3; If the answer is **No**, you can skip question 1.2 and 1.3)

1.2 How loud is the sound that you hear?

Quiet



Loud

1.3 What is your assessment of the sound that your hear?



### Part 2. Assessment of air movement

2.1 Can you feel any air movement at the location where you are sitting?

Yes

No

(If the answer is **Yes**, please continue with question 2.2-2.4; If the answer is **No**, you can skip question 2.2-2.4)

2.2 At which part(s) of your body do you feel the air movement? Please mark the body part(s) with "x".



2.3 How strong is the air movement that you feel?

Mild



Strong

2.4 What is your assessment of the air movement that you feel?

